

More Power for America

POPULAR MECHANICS

MAGAZINE



WRITTEN SO YOU CAN UNDERSTAND IT

REG. U.S. PAT. OFF.

REG. U.S. PAT. OFF.

MAY
25 CENTS
30c IN CANADA



BUY
UNITED STATES
DEFENSE
SAVINGS BONDS

SEE PAGE 14



but here is one worry you can avoid

MAYBE you can't buy new tires, but you can make your old ones last longer by giving them extra care.

And you can make your *car* last longer, too, if you take *extra* care to avoid *extra* wear on your car's king pins, tie rods, steering crank bearings and other vital friction points that means costly repair bills when neglected! Play safe—with Marfak bumper-to-bumper *chassis lubrication* every 1,000 miles!

Marfak is super-tough. Applied by chart, not by chance—it resists wear-out, wash-out and squeeze-out.



TUNE IN FRED ALLEN every Sunday night. See your local newspaper for time and station.

For your peace of mind, never say "grease job." Insist on reliable Marfak chassis lubrication—your insurance against costly repair bills. At Texaco and other good dealers everywhere.



You're Welcome at **TEXACO DEALERS**

Popular Mechanics Magazine

Registered in U. S. Patent Office and Canada

H. H. WINDSOR, Founder

H. H. WINDSOR, Jr., Editor and Publisher

May, 1942

Vol. 77, No. 5

IN THIS ISSUE

Substitutes We'll Keep	1
"The Marines Have Landed—" . . .	8
More Power for America	17
Arming Civilians for Defense . . .	28
Sports Secrets in a Flash	34
Mechanics of a Blackout	40
Billions Waiting to Be Taken . . .	50
How to Outsmart the Fish	56
"Tracer Bullets" of Science	62
The Race of the "Ironing Boards" . .	66
They Shoot on Sight	72
Training the Glider Army	82
Making Your Car Do for the Duration	92

Where-to-Buy-It Index Starts on Next Page

If You Can Drive, You Can Fly

ONE lesson and you can fly an airplane. You push the throttle in to the hilt, and when you're rolling, ease back on the wheel and climb. To turn left, swing the wheel left. No pedals to worry about. In a few minutes you're at home in the sky! Sounds awfully simple. Well, one of our staff members, never in a cockpit before, after one trip with a pilot at the controls of the new rudderless, spinproof plane, flew it up and landed it a half dozen times. He's back, alive, to tell you in three articles, beginning next month, that "If You Can Drive, You Can Fly."

The Demon Fire in Disguise

OPENING the faucet of a tank of thinner, an aircraft-factory worker started to fill an empty bucket. It blew up in his face! Fire broke out mysteriously in a ship's hold when a case of photographers' flash bulbs was broken. A whole new set of hazards has arisen in the new materials industry is using. Read "New Disguises of the Demon Fire" in June.

Next Month

SOME day we'll need fewer people than live in New York City to raise enough food for the whole population of the United States. In Revolutionary times 75 percent of the people were farmers; today, 25 percent. Long-range weather forecasts, better control of pests, scientific plant feeding, breeding of healthier plants that produce bigger crops per acre, mechanization of the farms—all these are elements in "The Revolution in Farming" that has made us the greatest agricultural nation. Look for that story in the June issue.

Dogs of War

THEY work twelve hours a night, these army dogs, and like the rest of us they get one night off every week. "U. S. Army Dog Sentry," reads the identification tag on the collar. They go to school to learn their special duties, and night after night they stand guard and walk beats with a soldier patrolling fortified areas. They've more "sense" than a human sentry, you'll agree when you read their story next month.

Shoot Them in Color

INDOORS or out, you can capture a beautiful world of color on film, and it doesn't take a costly array of equipment and a tricky camera to do it. What it does take is explained for you in the June Coloroto section, accompanied by Kodachrome pictures in full color and other photos showing the necessary equipment, exposure guides and other valuable helps.

Published monthly by POPULAR MECHANICS COMPANY, 200 East Ontario Street, Chicago, U. S. A. Single copy in the United States, 25 cents; subscription rates in United States and possessions, and countries of the Pan-American Postal Union including Spain, \$2.50 a year. Single copy in Canada, 30 cents; subscription rates, \$3.00 a year. To all other countries add \$1.00 a year over United States prices for overseas postage. Changes in address must be reported to us immediately to eliminate delay. Entered as Second Class Matter, Sept. 15, 1903, at the Post Office at Chicago, Illinois, under Act of March 3, 1879. Entered as Second Class Matter at Post Office Dept. Canada.

Copyright 1942, by Popular Mechanics Company, Copyright under International Copyright Union. All rights reserved under Pan American Copyright Union. Printed in the United States of America

Get Pyroil's

PRECIOUS PROTECTION FOR VITAL METAL PARTS

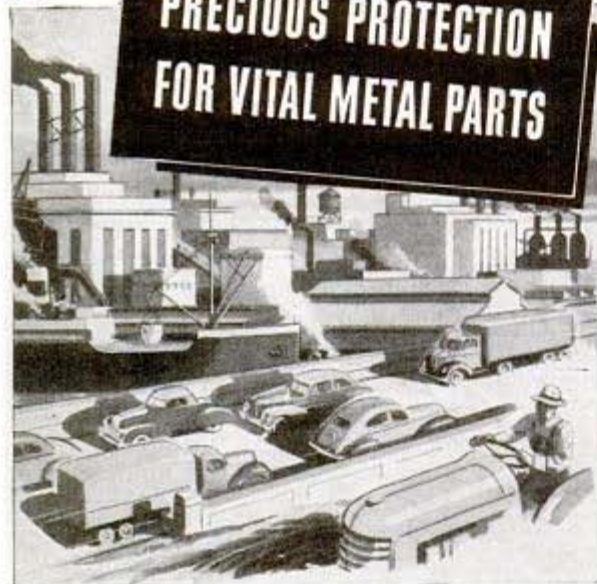

Keep Machinery, Tools and Farm Equipment From Breakdown—Make Your Car or Truck Last Longer

Keep tools and machines—and automobiles—from breakdown and you keep America safe. Keep moving things, moving; keep rolling things, rolling!

Pyroil is helping to do this big job. It is keeping power-stealers and metal-wreckers like excessive friction, sludge, gum, "varnish", carbon, and acid-corrosive substances, out of engines and machines. Under the strain of war production schedules, Pyroil now more than ever is precious protection.

Pyroil is super lubrication—different from your regular lubricant. You use it by mere ounces.* Users find in it, smoother, better operation; increased power and capacity; reduced operation costs; less breakdown and repair.

Pyroil saves far more than its cost. Yet its cost is mere pennies per hundreds of hours, or miles, of running. Get Pyroil's precious protection today. Manufactured and guaranteed by

Pyroil Company,
W. V. Kidder,
Founder, 55 Pyroil
Bldg., LaCrosse,
Wisconsin, U. S. A.



*You can purchase Pyroil from your local supplier. Add only a few ounces to lubrication boxes of machinery, and to crankcase and fuel tank of car. Or your service station, garage or supply store salesman will service it for you on the spot.



DISTRIBUTORS:
CHECK AND MAIL
COUPON FOR FRANCHISE FACTS.

PYROIL COMPANY
55 Pyroil Bldg., LaCrosse, Wisconsin

I would like to know how Pyroil will apply to my particular need—in machinery, equipment or automobile. Please send full information, at no obligation.

Send details of your Plan for Distributors.

Name.....

Address.....

City..... State.....

"KEEP 'EM ROLLING!"

WHERE-TO-BUY-IT INDEX

Where no name and address appear directly under an item, the product is not believed by us to be commercially available

Pneumatic earth auger.....	5
Circulator dries air.....	5
The General Air Conditioning Corp., Cincinnati, Ohio	
Tin cans turned into copper.....	5
Electric blower dries boots.....	6
The Chicago Hardware Foundry Co., North Chicago, Ill.	
Motorcycle carries two passengers.....	6
Home baler for newspapers.....	6
Washburn Co., Room 944, Merchandise Mart, Chicago	
Target simulates enemy battle line.....	7
Flexible plastic photoflash bulb.....	7
Westinghouse Electric and Mfg. Co., East Pittsburgh, Pa.	
How to fall into a fire net.....	13
Chemical fireproofs shingles.....	13
De-Oxo-Lin Chemical Products, 3051 Roslyn, Los Angeles, Cal.	
Collapsible tubes of plastic.....	13
New England Collapsible Tube Co., New London, Conn.	
Bensel-Brice Co., 6404 Sunset Blvd., Los Angeles, Calif.	
Flying carriers for warplanes.....	14
Fluorescent wall lamp is adjustable.....	16
Colonial Premier Co., 466 W. Superior St., Chicago	
Flexible tool removes packing.....	16
Durametallic Corp., Kalamazoo, Mich.	
Tin salvaged by new process.....	16
Automatic typewriter with selector.....	16
American Automatic Typewriter Co., 614 N. Carpenter, Chicago	
Emergency car for air raids.....	25
Mirror helps teach sighting of rifle.....	25
Double-deck stretcher on bicycle.....	26
Trailer hauls two midget cars.....	26
Folding cradle makes ambulance of truck.....	26
Loud speaker helps direct pedestrians.....	27
Army plane carries "peep" cars.....	27
Folding step on back of truck.....	31
J. Martacho Mfg. Co., Syracuse, Nebraska	
Plastic strips in terrazzo floors.....	31
Manhattan Terrazzo Strip Co., 1915 Park Ave., New York City	
Pocket postal scale.....	32
Rudson-Wood, Inc., 11 W. 42nd St., New York City	
Cookie rollers make three designs.....	32
L. Gurrieri Co., 122 Chambers St., New York City	
Crayons show temperature of metal.....	32
Tempil Corp., 132 W. 22nd St., New York City	
Ankle reflectors worn in blackout.....	32
Airplane driven by air jet.....	33
Blackout awning.....	33
The Acklin Stamping Co., 1925 Nebraska Ave., Toledo, Ohio	
Bubble boat.....	38
Jack Tiffany, Inc., Barberton, Ohio	
Fruit knife saves juice.....	38
Plastic Creations, Inc., Atlantic City, N. J.	
Bulbs use 5 percent of total electricity.....	38
Ladder holds tools.....	39
Ira B. Fry, Merchandise Mart, Chicago	
Army hut model.....	39
Flashlight on blackout cane.....	39
Abercrombie & Fitch, Madison Ave. at 45th, New York City	
Track-riding drawing tool.....	43
Inter-Lakes Eng. Co., 261 St. Aubin Ave., Detroit, Mich.	
Helmet holds field glasses.....	44
Man power of warring nations.....	44
Glass filter for tobacco pipe.....	44
GlaSorb Co., Empire State Bldg., New York City	
Phone in welding helmet.....	45
Tanks resemble torpedoes.....	45
Tips for table toppers.....	46

(Continued to page 6A)

"MINE WAS THE SLEEP BEFORE DEATH!"



A true experience of ROLAND WILSON, Littlefield, Texas



"**DESPERATELY TIRED** from a sick-bed vigil, I fell asleep while driving one night," writes Mr. Wilson. "My car swerved from the road... mowed down four heavy highway markers... and crashed with terrific impact against a concrete culvert. Then it made a final crazy plunge to the bottom of an embankment.

"**WHEN I CAME TO**, my car was upside down beside me, a mass of crumpled junk. Spasms of pain wracked my body, and my legs were paralyzed. I realized that I needed help, but I was off the road, so motorists could not see me. Then... I thought of the flashlight I always carry in my car.



"**DRAGGING MY USELESS** legs... I managed to reach it. I flipped the switch... turned the light toward the road above and waved it weakly. People in a passing car saw the bright beam... came down and picked me up. I was badly injured, but thanks to dependable 'Eveready' fresh DATED batteries I escaped death.

(Signed) *Roland Wilson*

The word "Eveready" is a registered trade-mark of National Carbon Company, Inc.



FRESH BATTERIES LAST LONGER... Look for the DATE-LINE

NATIONAL CARBON COMPANY, INC., 30 EAST 42nd STREET, NEW YORK, N. Y.

Unit of Union Carbide and Carbon Corporation



This One



Y82X-7FD-1BWY

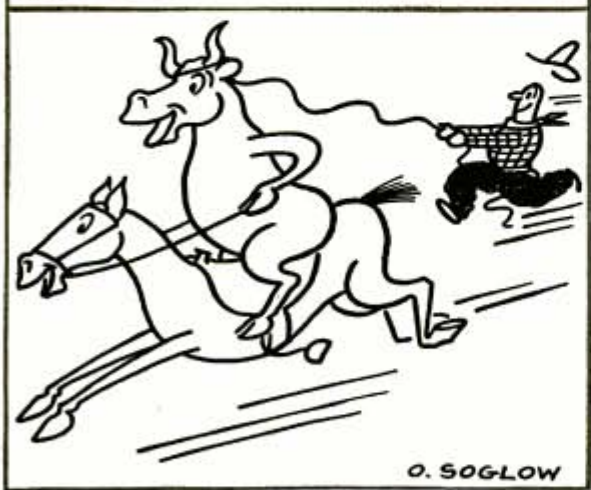
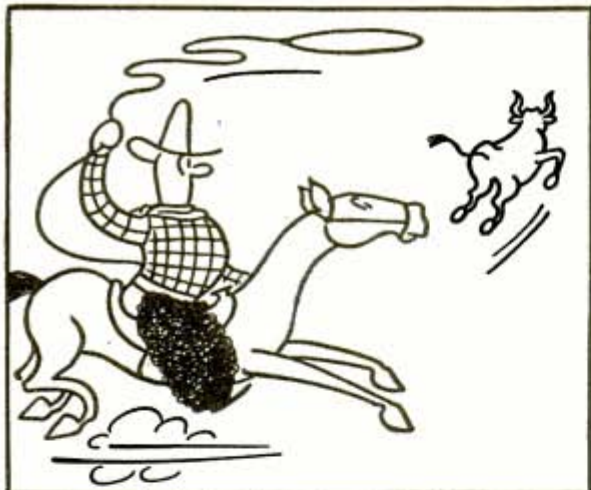

Purity...
in the big big bottle
... that's **PEPSI-COLA**

(Continued from page 4A)

Heaviest bomb dropped on Britain.....	48
Ban cameras in civil planes.....	48
Adsorber deodorizes air.....	48
Dorex Div., W. B. Connor Corp., 114 E. 32nd St., New York	
Wool substitute from redwood bark.....	49
Pacific Lumber Co., 100 Bush St., San Francisco, Calif.	
New war tools from old.....	49
Blackout shade for home.....	54
Clopay Corp., Clopay Square, Cincinnati, Ohio	
Corkscrew combined with puller.....	54
G. M. Thurnauer Co., 6 E. 20th St., New York City	
Chemically treated wood.....	54
The DuPont Co., Wilmington, Del.	
Dispensing cup on bottle top.....	54
G. M. Thurnauer Co., 6 E. 20th St., New York City	
Foiling tire thieves.....	55
Lug locks: Ivano, Inc., 123 E. 21st St., Chicago	
Certified Brands, Inc., 1421 S. Michigan, Chicago	
Champ Items, Inc., 6191 Maple Ave., St. Louis, Mo.	
Brand. iron: Great Lakes Stamp Co., 2500 Irving Park, Chicago	
Rocking gun mount.....	61
Flashlight has three colored lenses.....	61
The Martin Co., Merchandise Mart, Chicago	
Hot ice made by pressure.....	61
Binoculars fold into case.....	64
Mandel Bros., State and Madison, Chicago	
Torque versus horsepower.....	64
Spinning brush cleans metal for rivets.....	64
Osborn Mfg. Co., Cleveland, Ohio	
Glass windbreak for beach.....	65
Pittsburgh Plate Glass Co., Pittsburgh, Penna.	
Blackout bulb sheds blue light.....	65
Wabash Appliance Corp., 335 Carroll St., Brooklyn, N. Y.	
Rhubarb grows extra crop.....	65
Clear glass is opaque at angle.....	70
Westinghouse Co., East Pittsburgh, Penna.	
War ends vast auto production.....	70
Broken sash cord replacement.....	70
J. M. Bruce Mfg. Co., Merchandise Mart, Chicago	
Two-man sub used by Japs.....	71
Lightning is man's benefactor.....	71
Disabled tank hauled on trailer.....	77
Brake-tester on two-wheeled cart.....	77
Hetzel Bros., 1972 S. Los Angeles St., Los Angeles, Calif.	
Show your colors.....	78
Illuminated sky map.....	80
D. & C. Research, 413 Main St., Glen Ellyn, Ill.	
Bracket holds ant poison.....	80
Wm. J. Rabe, Route 1, Box 334, Redlands, Calif.	
Transparent plastic tableware.....	80
G. M. Thurnauer Co., 6 E. 20th St., New York City	
Warplanes of the future.....	81
Portable hand-operated siren.....	81
The Sparks-Withington Co., Jackson, Mich.	
"Grass blitzer" trims airfield.....	86
Worthington Mower Co., Stroudsburg, Penna.	
Radioactive phosphorus treats cancer.....	86
Canopy guards freight cargo.....	87
Gen. Mill Equip. Co., 2021 Pennsylvania Ave., Kansas City, Mo.	
Multi-barrel strafing gun.....	87
Mining a city dump.....	88
Tire tool averts pinching tube.....	90
Weaver Mfg. Co., Springfield, Ill.	
Tool inserts and crimps rivet.....	90
B. F. Goodrich Co., Akron, Ohio	
Screen patch held by lead "buttons".....	90
A. B. Carlson & Co., Aurora, Ill.	
U. S. Navy blimp patrol.....	91
Sailors wear "arctic visor" masks.....	91
Dirigible gunner.....	96
Rubberless wheel may return.....	96
One-piece license plate holder.....	96
Aurora Equipment Co., Aurora, Ill.	

(Continued to page 8A)

This Bottle Neck is Your Opportunity



A very real bottle neck has occurred in industry.

The millions of men going to work in the defense industry and business boom need thousands—hundreds of thousands—of supervisors and executives. Expanding Government agencies are calling for many specialists. Regular business needs experts to take care of expansion and to replace men called to military service.

The need is for all sorts of executives and specialists—foremen, supervisors, superintendents, accountants, traffic men, tax experts, time keepers, department managers, auditors, cost experts, production men, etc. The need will grow and continue for years to come.

There just are not enough men ready for these places nor can industry take the time to train them. Thousands—scores of thousands—must get their own training.

That is your opportunity—if you are ready or will get ready quickly. Never again will you have such an opportunity to command the success you want. But you must act decisively—immediately. The more quickly you get ready,

the sooner these millions of new workers will be pushing you up the ladder.

And LaSalle Offers You Just the Help You Need

Our courses are practically built to order for this opportunity. Condensed, practical—the minimum of theory and the maximum of practice. Prepared for spare time study—you can go as fast or slowly as you wish. You need not wait until you finish—what you study tonight, you can use on the job tomorrow. All are specialized, executive training courses. They are moderate in cost and easy terms are available.

Some of our training programs may cover just the field in which you see opportunity. Read them in the coupon below. Then check the one about which you wish full information—and mail the coupon today. Remember—the sooner you start, the sooner you will be ready for the opportunity.

LASALLE Extension University A Correspondence Institution

Dept. 564-R
CHICAGO

I'd like to get ready for one of these supervisory jobs. So please send me your free 48-page booklet on the field I have checked below—and full information about your training in that field.

- | | | |
|--|---|---|
| <input type="checkbox"/> Industrial Management | <input type="checkbox"/> Traffic Management | <input type="checkbox"/> Executive Management |
| <input type="checkbox"/> Modern Foremanship | <input type="checkbox"/> Salesmanship | <input type="checkbox"/> Business English |
| <input type="checkbox"/> Accounting | <input type="checkbox"/> Law | <input type="checkbox"/> Stenotypy |

Name.....Age.....

Address.....

Present Position.....



"Simoniz Makes Finish Last"



U. S. Government Urges
Motorists to Protect
Finish Four Times a Year

NEEDED TO SAVE YOUR CAR'S BEAUTY!

Simoniz now! Then your car will stay beautiful . . . though you have to drive it for years. Simoniz stops dirt, moisture, and ultra-violet rays from dulling and destroying the finish. These saboteurs of beauty are constantly attacking the lacquer or enamel, even in your garage! So, the sooner you Simoniz, the longer your car's finish lasts!

THE SIMONIZ COMPANY, CHICAGO, U. S. A.

MOTORISTS WISE SIMONIZ



Sold everywhere by
dealers in automotive
supplies

(Continued from page 6A)

Recorded bugle calls on P. A. system.....	155
Crystal pickup tone equalizer.....	159
Astatic Microphone Lab., Inc., Youngstown, Ohio	
Combination insulation stripper tool.....	159
General Cement Manufacturing Co., Rockford, Ill.	
Vibration type crystal pickup.....	159
Astatic Microphone Lab., Youngstown, Ohio	
Electrolytic condenser nut wrench.....	159
Vaco Products Co., 1603 S. Michigan Ave., Chicago	
Multicoupler antenna system for apartment buildings	159
Amy, Aceves & King, Inc., 11 W. 42nd St., New York City	
Radio code practice units.....	159
Bud Radio Corp., 5205 Cedar St., Cleveland, Ohio	
Blackout-panel oscillograph.....	160
Allen B. Du Mont Laboratories, Passaic, N. J.	
Full range sound reproducer for FM.....	160
Jensen Radio Mfg. Co., 6601 S. Laramie Ave., Chicago	
Portable all-wave receiver.....	160
Zenith Radio Corp., 6001 Dickens Ave., Chicago	
Compact phono oscillator.....	160
Montgomery-Ward & Co., Chicago	

Craftsman and Shop Notes Index

AUTOMOTIVE

Warning stripes on garage doors.....	99
Keep your car looking new.....	139
Maps on delivery-truck door.....	143
Siphon wets cleaning sponge.....	143
Accelerator socket for high heel.....	143
Truck body extension.....	145
Stones kept from wedging between tires.....	154

FARM

Keeping milk cool.....	119
Holder for stock salt.....	137
Feed-cooking kettle supported.....	138
Old tire holds feed basket.....	144
Jack regulates elevator speed.....	144
Protecting insulating board in brooder.....	145
Reel extensions prevent combine clogging.....	153
Marking trap door in hay loft.....	153

FURNITURE

Padded footstool.....	97
Three-tray table.....	113
Dinette set.....	120

HAND TOOLS

Diameter of cylindrical work found.....	122
Case for jigsaw blades.....	122
Feet improve level.....	138
Angle-iron guide on metal shears.....	138
Improvised gear puller.....	142
Gib head key puller.....	142
Removable cutting plate for anvil.....	144
Handy rack for turning chisels.....	145
Combination square and yardstick.....	145

HOUSEHOLD

Simulated wood pegs in floor.....	99
Solving home problems.....	100
Thimble holder and scissors guard.....	102
Paint-locked sash loosened.....	113
Peeling hot potatoes.....	119
Shield on sewing machine wheel.....	122
Yarn steamed on rack.....	122

(Continued to page 10A)



"I'm IN A CLASS BY MYSELF!"

"Yessir, that's true! Ever since I enrolled for special training with the International Correspondence Schools, I've been 'in a class by myself.' Because every I. C. S. student is really a one-man class. His classroom is in his own home, and there aren't any slow-pokes or dunces to hold him back! He gets *personal, individual instruction!*

"Maybe that's why it takes only a few months for many I. C. S. students to get specialized training that 'pays out' in promotion or a fatter pay envelope. As a matter of fact, a few weeks after I began studying, my boss noticed the improvement in my work — and, since then, I've been given a more responsible job.

"Right now, of course, there's a terrific shortage of trained men in industry — and if you're as smart as I think you are, you'll mark this coupon and mail it. And I don't mean tomorrow!"

INTERNATIONAL CORRESPONDENCE SCHOOLS

HELPING TO TRAIN AMERICANS FOR VICTORY



BOX 5633-J, SCRANTON, PENNA.

Without cost or obligation, please send me a copy of your booklet, "Who Wins and Why," and full particulars about the course *before* which I have marked X:

TECHNICAL AND INDUSTRIAL COURSES

- | | | | |
|--|--|---|--|
| <input type="checkbox"/> Air Brake | <input type="checkbox"/> Contracting and Building | <input type="checkbox"/> Marine Engines | <input type="checkbox"/> Sanitary Engineering |
| <input type="checkbox"/> Air Conditioning | <input type="checkbox"/> Cotton Manufacturing | <input type="checkbox"/> Mechanical Drafting | <input type="checkbox"/> Sheet Metal Work |
| <input type="checkbox"/> Airplane Drafting | <input type="checkbox"/> Diesel Engines | <input type="checkbox"/> Mechanical Engineering | <input type="checkbox"/> Ship Drafting |
| <input type="checkbox"/> Architectural Drafting | <input type="checkbox"/> Electrical Drafting | <input type="checkbox"/> Mine Foreman | <input type="checkbox"/> Shipfitting <input type="checkbox"/> Shop Practice |
| <input type="checkbox"/> Architecture | <input type="checkbox"/> Electrical Engineering | <input type="checkbox"/> Navigation | <input type="checkbox"/> Steam Electric <input type="checkbox"/> Steam Engines |
| <input type="checkbox"/> Auto Engine Tune-up | <input type="checkbox"/> Electric Lighting | <input type="checkbox"/> Patternmaking <input type="checkbox"/> Plumbing | <input type="checkbox"/> Steam Fitting |
| <input type="checkbox"/> Auto Technician | <input type="checkbox"/> Foundryman <input type="checkbox"/> Heating | <input type="checkbox"/> Practical Telephony | <input type="checkbox"/> Structural Drafting |
| <input type="checkbox"/> Aviation <input type="checkbox"/> Aviation Mechanic | <input type="checkbox"/> Heat Treatment of Metals | <input type="checkbox"/> Public Works Engineering | <input type="checkbox"/> Structural Engineering |
| <input type="checkbox"/> Boilermaking | <input type="checkbox"/> Highway Engineering | <input type="checkbox"/> Pulp and Paper Making | <input type="checkbox"/> Surveying and Mapping |
| <input type="checkbox"/> Bridge Engineering | <input type="checkbox"/> House Planning | <input type="checkbox"/> Radio, General | <input type="checkbox"/> Telegraph Engineering |
| <input type="checkbox"/> Chemistry | <input type="checkbox"/> Industrial Metallurgy | <input type="checkbox"/> Radio Operating | <input type="checkbox"/> Telephone Work |
| <input type="checkbox"/> Civil Engineering | <input type="checkbox"/> Locomotive Engineer | <input type="checkbox"/> Radio Servicing | <input type="checkbox"/> Textile Designing |
| <input type="checkbox"/> Coal Mining | <input type="checkbox"/> Machinist | <input type="checkbox"/> R. R. Section Foreman | <input type="checkbox"/> Toolmaking |
| <input type="checkbox"/> Concrete Engineering | <input type="checkbox"/> Management of Inventions | <input type="checkbox"/> R. R. Signaller <input type="checkbox"/> Refrigeration | <input type="checkbox"/> Woolen Manufacturing <input type="checkbox"/> Welding |

BUSINESS COURSES

- | | | | |
|--|--|--|---|
| <input type="checkbox"/> Accounting <input type="checkbox"/> Advertising | <input type="checkbox"/> College Preparatory | <input type="checkbox"/> First Year College | <input type="checkbox"/> Railway Postal Clerk |
| <input type="checkbox"/> Bookkeeping | <input type="checkbox"/> Commercial | <input type="checkbox"/> Foremanship <input type="checkbox"/> French | <input type="checkbox"/> Salesmanship |
| <input type="checkbox"/> Business Correspondence | <input type="checkbox"/> Commercial Illustrating | <input type="checkbox"/> Good English | <input type="checkbox"/> Secretarial <input type="checkbox"/> Spanish |
| <input type="checkbox"/> Business Management | <input type="checkbox"/> Cost Accounting | <input type="checkbox"/> High School | <input type="checkbox"/> Showcard and Sign Lettering |
| <input type="checkbox"/> Cartooning <input type="checkbox"/> Civil Service | <input type="checkbox"/> C. P. Accounting | <input type="checkbox"/> Managing Men at Work | <input type="checkbox"/> Traffic Management |

HOME ECONOMICS COURSES

- | | | |
|---|---|---|
| <input type="checkbox"/> Advanced Dressmaking | <input type="checkbox"/> Home Dressmaking | <input type="checkbox"/> Tea Room and Cafeteria |
| <input type="checkbox"/> Foods and Cookery | <input type="checkbox"/> Professional Dressmaking and Designing | <input type="checkbox"/> Management, Catering |

Name..... Age..... Address.....
 City..... State..... Present Position.....

Canadian residents send coupon to International Correspondence Schools Canadian, Limited, Montreal, Canada
 British residents send coupon to I. C. S., 71 Kingsway, London, W. C. 2, England

Perfect Fitting MITRES
Every Time!

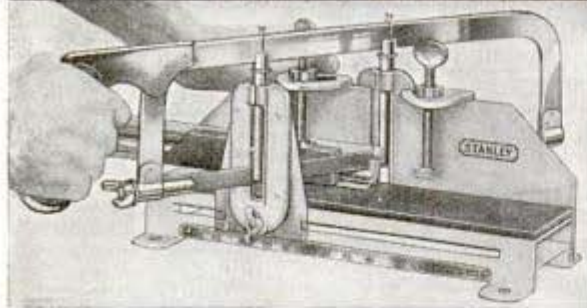

Here's your answer to a low cost Mitre Box for accurate angle cuts in metal, wood and plastics. Stanley No. 2360.

NOT THIS!



NOT THIS!



NOT THIS!



1. Takes work up to 2 1/4" high x 3 1/4" wide.
2. Compact - 12 1/2" x 5 1/4" - requires little bench space.
3. Sliding front guide and graduated scale assure accurate cuts - at any angle from 45° to 90° right and left.
4. Work positively clamped in place while cut is made.
5. Saw lifts out for ordinary hack saw uses.
6. Sturdy, steel frame - cast iron saw guides reinforced with steel - pressed wood, replaceable base board.
7. Equipped with 12" x 1/2", 32 tooth, saw blade for metal work. Your hardware dealer has blades for softer materials. Ask him to show you this new Mitre Box.

Write for Catalog No. 34 showing Mitre Box No. 2360 and hundreds of other Stanley Tools.

STANLEY TOOLS

DIVISION OF THE STANLEY WORKS

105 ELM STREET . . . NEW BRITAIN, CONN.

(Continued from page 8A)

LAWN AND GARDEN

V-notch in hoe.....102
Vegetables at your back door.....114
Stake unit for row marker.....118
Flag marks hose across sidewalk.....119
Decorative sprinkler.....129

OFFICE

Adjustable window ventilator.....102
Drawing accurate curves.....118
Paper clips held on file drawer.....138

PHOTOGRAPHY

Simple enlarger.....130
Flash-flood lamps.....133
Enlarging meter read easily.....134
Photo solution skimmer.....134

POWER TOOLS

Paint-brush cleaner in drill press.....118
Running small belt sander.....135
Duplicate collars cut quickly.....136
Metal-turning lathe set-ups.....146

RADIO AND ELECTRICITY

Power pack for electric razor.....99
Preventing burnt out flashlight bulbs.....119
"Veep" broadcast receiver.....156
How to make a 3-circuit tuner.....158
Line voltage reducer for small power packs.....159
Tapping hammer for set testing.....159
Bi-directional receiving antenna.....159

STORE AND SHOP

Saving seed spilled on scales.....137
Loading lumber on truck.....137
Paper-cutter gauge.....142
Clearing path for hand truck.....154

TOYS AND MODELS

Cutting toy wood wheels.....102
Bathers' floats.....103
Ship model "Constellation".....106
Electrical snap connectors.....122

MISCELLANEOUS

Holding lantern on boat deck.....104
Heavy quilts kept off patient's feet.....104
Blacked-out window has air vents.....104
Before buying a house.....123
Cover speeds opening of drain.....129
Rubber ball as tack container.....138
Surveyor uses bottle caps as markers.....142
Stationery holder in suitcase lid.....144
Anchoring bolts in wet concrete.....153
Ladder used as workbench.....153

IMPORTANT NOTICE

It is the intention of this magazine to provide its readers with information regarding the latest developments in the mechanical arts. We take no responsibility as to whether the disclosures contained in our articles are covered by patents and advise readers to investigate this subject before making, using, or selling any of the products, machines, or processes described in order to avoid possible liability for patent infringement.

**AUDELS NEW
MACHINISTS
HANDY BOOK
NOW READY!**

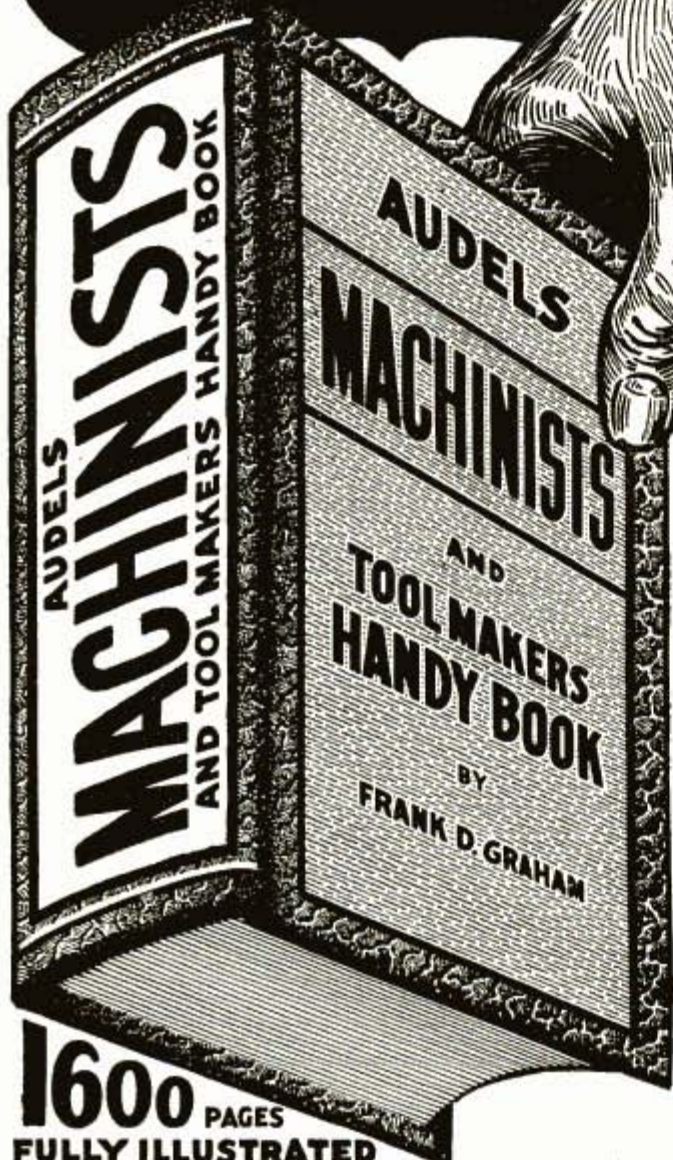

Prepare!

**A KEY TO
MODERN SHOP PRACTICE**

PRACTICAL INSIDE INFORMATION
For Every Machinist, Toolmaker, Engineer, Machine Operator, Mechanical Draughtsman, Metal Worker, Mechanic or Student. This 1600 Page Handy Book Covers Modern Machine Shop Practice in All Its Branches.

**A COMPLETE INSTRUCTOR WITH
READY REFERENCE INDEX**
New from Cover to Cover. Tells How to Operate and Set Up Lathes, Screw & Milling Machines, Shapers, Drill Presses & All Other Machine Tools.

**5 PRACTICAL BOOKS IN ONE!
60 FULLY ILLUSTRATED CHAPTERS**
Covering: **1**—Modern Machine Shop Practice. **2**—Blue Print Reading and How to Draw. **3**—Calculations & Mathematics for Machinists. **4**—Shop Physics. **5**—How to Use the Slide Rule.

...ASK TO SEE IT!...

THEO. AUDEL & CO., 49 West 23rd St., New York
Mail AUDELS MACHINISTS & TOOLMAKERS HANDY BOOK, Price \$4 on 7 Days Free Trial. If O. K. I will remit \$1 in 7 days and \$1 Monthly until \$4 is Paid. Otherwise I will return it.

Name _____
Address _____
Occupation _____
Reference _____ P.M.

**1600 PAGES
FULLY ILLUSTRATED**
A SHOP COMPANION THAT ANSWERS YOUR QUESTIONS
Easy to read and understand—flexible covers—Handy size 5 x 6½ x 2—a ready reference that answers your questions accurately.

TO GET THIS ASSISTANCE FOR YOURSELF SIMPLY FILL IN AND MAIL COUPON TODAY

**\$4 COMPLETE
PAY \$1 A
ONLY 1 MO.**

THEO. AUDEL & CO., 49 W. 23rd St., New York



Know Electricity as Experts Know It—and Get an Expert's Pay!

What about your future? Who is safe today? Surely not the man who is contented to stand still! Know your job thoroughly—prepare yourself for jobs ahead. To do just this thousands of men have used

The Croft Library of Practical Electricity

The Croft Library is a complete electrical educator. It is founded on practice—on 20 years of shirt-sleeve experience—on work as it is actually done. It is jammed from cover to cover with the kind of hard-headed facts you want. Written so that the beginner can easily understand it, yet so sound, so thorough, that it is the daily guide of 59,000 highly paid electrical workers and engineers. Croft tells you the things you need to know about motors, generators, armatures, commutators, transformers, circuits, switchboards, distribution systems—electrical machinery of every type—wiring for light and power—wiring of finished buildings—underwriters and municipal requirements—illumination in its every phase—the most improved methods of lighting—lamps and lamp effects, etc.—how to do a complete job, from estimating it, to completion.

No money down — easy payments

Fill in and mail the coupon attached and we will send you the entire set of seven volumes for ten days' examination on approval. We take all the risk—you assume no obligation. If you decide to keep the books, send \$3.00 in ten days and the balance at the rate of \$3.00 a month. Send the coupon NOW and see the books for yourself.

EXAMINATION COUPON

McGraw-Hill Book Co., 330 W. 42nd St., New York

Send me for ten days' examination on approval the Croft Library of Practical Electricity, 7 vols. If satisfactory I will send you \$3.00 in 10 days and \$3.00 monthly until the price of \$18.00 is paid. If not wanted, I will return the books postpaid. (To insure prompt shipment write plainly and fill in all lines.)

Name.....
Home Address.....
City and State.....
Position.....
Name of Company..... PM-542

Do you want

- .. to go to College?
- .. or to enter a Profession?
- (Such as Accounting, Architecture, Nursing, Dentistry, Teaching, Social Work, Osteopathy, Beauty Culture, Optometry, Embalming, Chiropractic, Law, Medicine, etc.)
- .. or get an Office Position?

To get anywhere, you practically MUST finish High School FIRST. You can complete our simplified High School Course in SPARE time at home, as FAST as your time and abilities permit. Equivalent to resident school work—prepares you for college, pre-professional examinations, business, industry. Standard texts furnished. Diploma. Credit for H.S. subjects already completed. Single subjects if desired. Low tuition, easy terms. American School, Chicago, est. 1897—endorsed by educators. Finish your high school education NOW. Write TODAY!

High School Course at Home

Many Finish in 2 Years

American School, Dept. H545, Drexel Ave. at 58th St., Chicago, Ill.

Gentlemen: Send me FREE information covering special training in subjects checked below. No obligation on my part.

- | | |
|--|---|
| <input type="checkbox"/> High School Course | <input type="checkbox"/> Diesel Engineering |
| <input type="checkbox"/> Accounting and Auditing | <input type="checkbox"/> Drafting and Design |
| <input type="checkbox"/> Architecture and Building | <input type="checkbox"/> Liberal Arts |
| <input type="checkbox"/> Automotive Engineering | <input type="checkbox"/> Private Secretary |
| <input type="checkbox"/> Business Management | <input type="checkbox"/> Mechanical Engineering |
| <input type="checkbox"/> Aviation | <input type="checkbox"/> Radio and Television |
| <input type="checkbox"/> Electrical Engineering | <input type="checkbox"/> Salesmanship |
| <input type="checkbox"/> Elec. and Gas Refrigeration | <input type="checkbox"/> Business Law |
| <input type="checkbox"/> Air Conditioning | <input type="checkbox"/> Retail Merchandising |

Name.....
Address.....

PARKS AIR COLLEGE

PARKS AIRPORT EAST ST. LOUIS, ILL.

Offers YOU COLLEGE and PROFESSIONAL TRAINING Majoring in AVIATION

Accredited by the Illinois Superintendent of Public Instruction. "Included in the Accredited Higher Institutions 1938, issued by the U. S. Office of Education, Federal Security Agency." U. S. approved as a Commercial Ground and Flying School and Mechanics' School. Accredited by and cooperating with the United States Army Air Corps in giving flight and mechanical training. Open to high school graduates. FOUR courses lead to B.S. degrees in Professional Piloting, Aviation Operations, Maintenance Engineering, Aeronautical Engineering. TWENTY-TWO TRAINING PLANES are used in professional flight training which prepares graduates for airline flight operations. FACULTY of 82 specialists in various fields of aviation. 1569 graduates. Enrollment limited to a total of 300 commercial aviation students. Capacity enrollment of 560. 100-acre airport, 25 buildings devoted to school purposes exclusively. Dormitories and dining hall at the College. Summer term July 6. Send postcard for new 64-page catalog.

15th YEAR Registrar, Dept. PM-5
PARKS AIR COLLEGE, East St. Louis, Ill.

ENGINEERING DEGREE IN 27 MONTHS

INDIANA
TECHNICAL
COLLEGE

Courses in Aeronautical, Chemical, Civil, Electrical, Mechanical, and Radio Engineering. One-year courses in Radio and Drafting. Approved by C.A.A. Prep courses without added cost. Low tuition. Large industrial center. Opportunity to earn part living expenses. Enter June, September, December, March. Catalog. 552 E. Washington Blvd., Ft. Wayne, Ind.

BECOME AN EXPERT MEAT CUTTER

Greater opportunities! Thousands of firms are needing expert Meat Cutters. Train in 6 weeks at famous National School. It's quick, easy to learn Meat Cutting by ACTUAL PRACTICE in big National cutting rooms and retail department. No previous experience or advanced education necessary. BIG PAY JOBS. Union card guaranteed. Employment service FREE. Train first. Pay later. Easy terms. Write TODAY for FREE catalog and plans to help you get ahead.

National School of Meat Cutting, Inc., Dept. U-30, Toledo, Ohio

TRAIN Your VOICE!

Results GUARANTEED

We build, strengthen the vocal organs—not with singing lessons—but by sound, scientifically correct silent and vocal exercises and absolutely guarantee complete satisfaction with results. Write for Voice Book, FREE. Sent to no one under 17 years old unless signed by parent.

PERFECT VOICE INSTITUTE, Studio 1355, 64 E. Lake St., Chicago, Ill.

Learn Profitable Profession in 90 days at Home

Earnings of Men and Women in the fascinating profession of Swedish Massage run as high as \$40 to \$70 per week but many prefer to open their own offices. Large incomes from Doctors, hospitals, sanitariums and private patients come to those who qualify through our training. The Army and Navy need hundreds trained in massage. Write for Anatomy Charts and booklets—They're FREE.

THE COLLEGE OF SWEDISH MASSAGE
30 E. Adams St., Dept. 564, Chicago

Learn PHOTOGRAPHY at Home

Splendid opportunities. Prepare in spare time. Easy plan. No previous experience needed, common school education sufficient. Send for free booklet "Opportunities in Photography", particulars and requirements.

American School of Photography
1315 Michigan Ave., Dept. 1355, Chicago, Ill.

MONEY for MEN ALL FREE

THE PLASTEX Industry needs manufacturers on small scale and for big production of Lamp and Clock Stands, Art Goods and Novelties in Plastex and Marble imitation. Experience unnecessary. 1/2c material makes regular 10c store sellers. Rubber moulds furnished for speed production. Small investment brings good returns. WE ARE NOW PLACING BIG CHAIN STORE ORDERS WITH MANUFACTURERS. Ambitious men have chance for real prosperity. Our FREE booklet will interest and benefit you.

PLASTEX INDUSTRIES, Dept. LP, 1085 Washington Ave., New York, N.Y.

Do You Want Success Like This in RADIO



BEFORE COMPLETING YOUR COURSE I OBTAINED MY RADIO BROADCAST OPERATOR'S LICENSE AND IMMEDIATELY JOINED STATION WMPC WHERE I AM NOW CHIEF OPERATOR.

HOLLIS F. HAYES
327 MADISON ST., LAPEER, MICH.

I WAS WORKING IN A GARAGE WHEN I ENROLLED WITH N. R. I. I AM NOW RADIO SERVICE MANAGER FOR M.----- FURNITURE CO. FOR THEIR 4 STORES.

JAMES E. RYAN
119 PEBBLE COURT
FALL RIVER, MASS.



CLIPPING YOUR COUPON GOT ME STARTED IN RADIO. I AM NOW IN CHARGE OF THE RADIO DEPARTMENT FOR THE AMERICAN AIRLINES AT CLEVELAND.

WALTER B. MURRAY
AMERICAN AIRLINES, MUNICIPAL AIRPORT, CLEVELAND, OHIO.



MY LOUDSPEAKER SYSTEM PAYS ME ABOUT \$35 A WEEK BESIDES MY RADIO WORK. IF IT HAD NOT BEEN FOR YOUR COURSE I WOULD STILL BE MAKING COMMON WAGES.

MILTON I. LEIBY, JR.
TOPTON, PA.



I HAVE BEEN IN BUSINESS FOR MYSELF FOR TWO YEARS, MAKING BETWEEN \$200 AND \$300 A MONTH. BUSINESS HAS STEADILY INCREASED.

ARLIE J. FROEHRER
300 W. TEXAS AVE.
GOOSE CREEK, TEX.



I MAKE \$40 A MONTH FIXING RADIOS IN SPARE TIME. I STARTED MAKING EXTRA MONEY 3 MONTHS AFTER BEGINNING THE N. R. I. COURSE AND MADE ABOUT \$100 WHILE LEARNING.

WILLIAM CHERMAK
RT. 1, BOX 287
HOPKINS, MINN.



Here's The Formula That Has Worked For Hundreds

If you're looking for a quick way to better pay, and a chance to get a good, permanent job in a field of real opportunity, here's the formula that has worked for the men you see above, and hundreds of others, too. It's not a "miracle cure" nor a "long-chance" operation. It is a time-tested, practical way to train at home to make \$5 to \$10 a week extra a few months from now, and to prepare for a full-time job paying up to \$50 a week as a Radio Technician or Radio Operator.

Many Make \$5, \$10 a Week Extra in Spare Time While Learning

Nearly every neighborhood offers opportunities for a good part time Radio Technician to make extra money fixing Radio sets. I give you special training to show you how to start cashing in on these opportunities early. You get Radio parts and instructions for building test equipment, for conducting experiments which give you valuable practical experience. My 50-50 method—half working with Radio parts, half studying my lesson texts—makes learning Radio at home interesting, fascinating, practical.

I Trained These Men at Home I Will Train You Too

Beginners Train at Home and Make Up to \$50 a Week

The 882 broadcasting stations in the U. S. employ Radio Technicians with average pay among the country's best paid industries. The Radio repair business is booming due to shortage of new sets. Repairing, selling, servicing, installing home and auto Radio receivers (there are 57,400,000 in use) gives good jobs to thousands. Many N. R. I. trained Radio Technicians take advantage of the opportunities to have their own full time or spare time Radio service businesses. The Government needs many Civilian Radio Operators, Technicians. Think of the many good jobs in connection with Aviation, Commercial, Police Radio and Public Address Systems. N. R. I. gives you the required knowledge of Radio for these jobs. N. R. I. trains you to be ready when Television opens jobs in the future. Yes, N. R. I. trained Radio Technicians make good money because they use their heads as well as their hands. They are THOROUGHLY TRAINED. Many N. R. I. trained men hold their regular jobs, and make extra money fixing Radio sets in spare time.

Find Out How N. R. I. Teaches Radio and Television

Act today. Mail coupon now for 64-page Book. It's FREE. It points out Radio's spare time and full time opportunities and those coming in Television; tells about my Course in Radio and Television; shows more than 100 letters from men I trained, telling what they are doing and earning. Find out what Radio offers you. Mail coupon in envelope or paste on penny postcard NOW.

J. E. SMITH, President
Dept. 2EP, National Radio Institute
Washington, D. C.



THIS FREE BOOK HAS SHOWN HUNDREDS HOW TO MAKE GOOD MONEY

J. E. SMITH, President, Dept. 2EP
National Radio Institute, Washington, D. C.

Mail me FREE without obligation, your 64-page book "Rich Rewards in Radio." (No salesman will call. Write plainly.)

AGE.....



NAME.....

ADDRESS.....

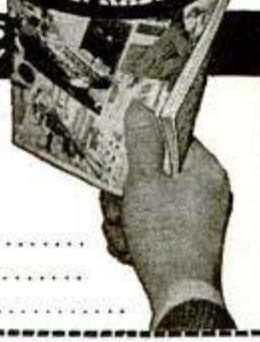
CITY..... STATE.....



Extra Pay in Army, Navy, Too

Men likely to go into military service, soldiers, sailors, marines, should mail the Coupon Now! Learning Radio helps men get extra rank, extra prestige, more interesting duty at pay up to 6 times a private's base pay. Also prepares for good Radio jobs after service ends. IT'S SMART TO TRAIN FOR RADIO NOW!

Learn WELDING This Easy Way!

AUDELS NEW WELDERS GUIDE

Contains Important Facts and Essential Information!

- WELDING METHODS
- WELDERS
- ELECTRIC
- OXY-ACETYLENE
- THERMIT
- UNIONMELT
- SHEET METAL
- SPOT
- PIPE
- PRESSURE VESSELS
- VARIOUS METALS
- AIRPLANE
- HARDENING-FACING
- CUTTING
- EYE PROTECTION

Just Out!

\$1

QUESTIONS AND ANSWERS

Every Welder Should Own This New, Useful Book containing clear, concise, practical information, pointers and facts relating to modern practice in all Branches. Easy to read and understand—over 400 pages Fully Illustrated—flexible cover—pocket size—a Ready Reference that Answers Your Questions accurately—Money Back if not O.K. To get this assistance for yourself, order copy today.

THEO. AUDEL, Publishers, 49 W. 23rd St., New York
 Please mail AUDELS WELDERS GUIDE (Price \$1). If satisfactory, I will remit \$1 on its safe arrival, otherwise I will return the book.

Name _____
 Address _____
 Occupation _____
 Employed by _____ P.M.

AVIATION CAREER

Offers You
A GREAT FUTURE!

Complete Aeronautical Engineering or Master Aviation Mechanics training in the heart of the Aircraft industry. Graduates obtaining immediate employment. No flying involved. Aviation's foremost school, established in 1929. Located on Grand Central Air Terminal. For full information, address Department PM-5.

CURTISS TECHNICAL WRIGHT INSTITUTE

GRAND CENTRAL AIR TERMINAL
 GLENDALE (LOS ANGELES) CALIF.

THIS TOWER OVERLOOKS AVIATION'S MOST DISTINGUISHED SCHOOL OF AERONAUTICS

Be Your Own MUSIC Teacher



LEARN AT HOME

to play by note. Piano, Violin, Ukulele, Tenor Banjo, Hawaiian Guitar, Piano Accordion, Saxophone, or any other instrument. Wonderful improved method. Simple as A B C. No "numbers" or trick music. Cost averages only a few cents a day. Over 700,000 students.

FREE BOOK Write today for Free Booklet and Free Print & Picture Sample explaining this method in detail. Mention favorite instrument. Instruments supplied when needed each or credit.
U. S. SCHOOL OF MUSIC, 75 Brunswick Bldg., New York City

LEARN WATCH REPAIRING

AT HOME You can learn by our modern and original system of instruction every part of the **Watch Repairing Trade** at home. Prepare yourself for a well paying position or start in business after completing our course of instruction. Good watch repairers are in demand and generally earn very good salaries. For particulars apply to the **Wisconsin School of Watch Repairing** 524 E. Mason St., MILWAUKEE, WIS.

Regain Perfect Speech, If You STAMMER

Every stammerer should have the new 287 page book "Stammering, Its Cause and Correction." Sent free to stammerers. It describes the Bogue Unit Method for the scientific correction of stammering and stuttering. Method successfully used at Bogue Institute for 41 years—since 1901. Endorsed by physicians. Write for full information. No obligation. Benjamin N. Bogue, Dept. 1338 Circle Tower, Indianapolis, Indiana.

Learn PHOTO-ENGRAVING

We teach you quickly, at home in spare time. Earn while you learn. Establish your own profitable business with equipment we furnish, or work for others at good salary. Cuts in this magazine made by process we teach. Send for your copy of our big illustrated catalog. It's free!
THE AURORA SCHOOL OF PHOTO-ENGRAVING
 Tasoep' Bldg. (Dept. PM-40) Aurora, Mo.

Learn TO Write

Begin today. Write now for our Free Book, "How to Become a Good Penman." It contains specimens and tells how others learned to write in spare time. Enclose 10c for your name beautifully written and a pen point suitable for shaded writing. Write today.
THE TAMBLYN SCHOOL OF PENMANSHIP
 X441 Ridge Building, Kansas City, Mo.

RADIO ENGINEERING

broadcasting, aviation and police radio, servicing, marine and Morse telegraphy taught thoroughly. 48 weeks' engineering course equivalent to three years' college radio work. School established 1874. All expenses low. Catalog free.
The Dodge Institute, Dept. D, Valparaiso, Ind.

EARN THE DEGREE

Doctor of Psychology (Ph.D.), Doctor of Divinity (D.D.), many others. Courses in business, accounting, law, etc. Low fees. Send for large Bulletin and student picture-folder at ONCE. No obligation whatever.
TEMPLE BAR EXTENSION COLLEGE
 1411 Fourth Avenue, Dept. 4-R, Seattle, Washington, U. S. A.

LEARN WELDING

Both Electric Arc and Acetylene by practical Shop-Plan method in a few short weeks. No text-books. You learn by doing. Finest equipment. Low tuition. Pay-After-Graduation-Plan. Also, courses in Auto Mechanics, Collision Work, Metal Finishing, etc. Illustrated literature free. Write today.
MICHIGAN TRADE SCHOOL
 3738 Woodward, Detroit, Mich. **FREE 32 PAGE CATALOG**

Always write your name and full address clearly when answering advertisements.

I thought I knew
something about my
job—till I saw
that I. C. S.
catalog!



- This is a true story.
- Three successful men sat in the wash-room of a Pullman, discussing their backgrounds in business. Finally one said:
- "I used to wonder why I didn't get ahead on my job. I thought I knew enough about the work to rate a promotion. Then one day I saw an I. C. S. catalog on that line of work—saw the subjects covered by that I. C. S. Course. And I realized how LITTLE I knew!
- "Well, I enrolled for the course *pronto*—and that was the most important step in my business career! I not only learned how to master my present job, but prepared myself for the bigger one I now have! Believe me, it's true—the way to *get* a better job is to *do* better work on your present job! And that means TRAINING!"

Does lack of training stand between you and the fulfilment of your dreams and ambitions? Then do something about it! Mail this coupon, and learn how I. C. S. can help you achieve
SUCCESS!

INTERNATIONAL CORRESPONDENCE SCHOOLS
HELPING TO TRAIN AMERICANS FOR VICTORY



BOX 5634-J, SCRANTON, PENNA.

Without cost or obligation, please send me a copy of your booklet, "Who Wins and Why," and full particulars about the course *before* which I have marked X:

TECHNICAL AND INDUSTRIAL COURSES

- | | | | |
|--|--|---|--|
| <input type="checkbox"/> Air Brake | <input type="checkbox"/> Contracting and Building | <input type="checkbox"/> Marine Engines | <input type="checkbox"/> Sanitary Engineering |
| <input type="checkbox"/> Air Conditioning | <input type="checkbox"/> Cotton Manufacturing | <input type="checkbox"/> Mechanical Drafting | <input type="checkbox"/> Sheet Metal Work |
| <input type="checkbox"/> Airplane Drafting | <input type="checkbox"/> Diesel Engines | <input type="checkbox"/> Mechanical Engineering | <input type="checkbox"/> Ship Drafting |
| <input type="checkbox"/> Architectural Drafting | <input type="checkbox"/> Electrical Drafting | <input type="checkbox"/> Mine Foreman | <input type="checkbox"/> Shipfitting <input type="checkbox"/> Shop Practice |
| <input type="checkbox"/> Architecture | <input type="checkbox"/> Electrical Engineering | <input type="checkbox"/> Navigation | <input type="checkbox"/> Steam Electric <input type="checkbox"/> Steam Engines |
| <input type="checkbox"/> Auto Engine Tune-up | <input type="checkbox"/> Electric Lighting | <input type="checkbox"/> Patternmaking <input type="checkbox"/> Plumbing | <input type="checkbox"/> Steam Fitting |
| <input type="checkbox"/> Auto Technician | <input type="checkbox"/> Foundryman <input type="checkbox"/> Heating | <input type="checkbox"/> Practical Telephony | <input type="checkbox"/> Structural Drafting |
| <input type="checkbox"/> Aviation <input type="checkbox"/> Aviation Mechanic | <input type="checkbox"/> Heat Treatment of Metals | <input type="checkbox"/> Public Works Engineering | <input type="checkbox"/> Structural Engineering |
| <input type="checkbox"/> Boilermaking | <input type="checkbox"/> Highway Engineering | <input type="checkbox"/> Pulp and Paper Making | <input type="checkbox"/> Surveying and Mapping |
| <input type="checkbox"/> Bridge Engineering | <input type="checkbox"/> House Planning | <input type="checkbox"/> Radio, General | <input type="checkbox"/> Telegraph Engineering |
| <input type="checkbox"/> Chemistry | <input type="checkbox"/> Industrial Metallurgy | <input type="checkbox"/> Radio Operating | <input type="checkbox"/> Telephone Work |
| <input type="checkbox"/> Civil Engineering | <input type="checkbox"/> Locomotive Engineer | <input type="checkbox"/> Radio Servicing | <input type="checkbox"/> Textile Designing |
| <input type="checkbox"/> Coal Mining | <input type="checkbox"/> Machinist | <input type="checkbox"/> R. R. Section Foreman | <input type="checkbox"/> Toolmaking <input type="checkbox"/> Welding |
| <input type="checkbox"/> Concrete Engineering | <input type="checkbox"/> Management of Inventions | <input type="checkbox"/> R. R. Signalman <input type="checkbox"/> Refrigeration | <input type="checkbox"/> Woolen Manufacturing |

BUSINESS COURSES

- | | | | |
|--|--|--|---|
| <input type="checkbox"/> Accounting <input type="checkbox"/> Advertising | <input type="checkbox"/> College Preparatory | <input type="checkbox"/> First Year College | <input type="checkbox"/> Railway Postal Clerk |
| <input type="checkbox"/> Bookkeeping | <input type="checkbox"/> Commercial | <input type="checkbox"/> Foremanship <input type="checkbox"/> French | <input type="checkbox"/> Salesmanship |
| <input type="checkbox"/> Business Correspondence | <input type="checkbox"/> Commercial Illustrating | <input type="checkbox"/> Good English | <input type="checkbox"/> Secretarial <input type="checkbox"/> Spanish |
| <input type="checkbox"/> Business Management | <input type="checkbox"/> Cost Accounting | <input type="checkbox"/> High School | <input type="checkbox"/> Showcard and Sign Lettering |
| <input type="checkbox"/> Cartooning <input type="checkbox"/> Civil Service | <input type="checkbox"/> C. P. Accounting | <input type="checkbox"/> Managing Men at Work | <input type="checkbox"/> Traffic Management |

HOME ECONOMICS COURSES

- | | | |
|---|---|--|
| <input type="checkbox"/> Advanced Dressmaking | <input type="checkbox"/> Home Dressmaking | <input type="checkbox"/> Tea Room and Cafeteria Management, Catering |
| <input type="checkbox"/> Foods and Cookery | <input type="checkbox"/> Professional Dressmaking and Designing | |

Name.....Age.....Address.....
City.....State.....Present Position.....

Canadian residents send coupon to International Correspondence Schools Canadian, Limited, Montreal, Canada
British residents send coupon to I. C. S., 71 Kingsway, London, W. C. 2, England



MACHINE SHOP MEN

Learn to set up and run ANY kind of machine; MAKE MORE MONEY NOW by learning quickly HOW TO DO THINGS which usually take years of study and practice. The demand for SKILLED men is ALREADY ahead of the supply, then what WILL IT BE a month or two from now?

Needed NOW!

Bigger Pay Don't miss this chance to qualify for promotion, don't miss this Big Opportunity which is yours almost for the asking. Eight Big Books checkfull of important mechanical facts told simply and clearly. Over 3000 pages, nearly 3000 illustrations cover every subject fully, including Tool Making, Pattern Making, Foundry Work, Mechanical Drawing, Forging, Machine Shop Practice and Management, and hundreds of other subjects.

8 Big Books (Up-to-date Edition) Sent FREE

to you for examination. With them we send a Big Binder of nearly 800 pages with 267 original shop tickets with 1200 illustrations. These show, step by step, how to set up and run almost any kind of job and are in addition to the 8 books. Decide in your own home or place of business whether or not you want to keep them, check up on any facts you want to. Note their great MONEY MAKING value, then, if you want them, pay on the easiest kind of payments. A Year's consulting privileges with our engineers now given with these books without extra charge.

American Technical Society, Publishers—Home Study Courses.

American Technical Society, Dept. 5519, Drexel at 58th St., Chicago

You may send me the 8 big books and binder of shop tickets for free examination. I will pay the delivery charges only, unless I decide to keep them in which case I will send \$2.00 in ten days and \$3.00 per month until the total price of only \$34.80 is paid. If I return them in 10 days I will owe you nothing. You also agree to send me a certificate entitling me to consulting privileges with your experts for one year without extra charge.

Name.....

Address.....
Please attach a letter stating age, occupation, employer's name and address and that of at least one business man as reference.

NEW ELECTRIC LIBRARY

\$ 1.50 A VOLUME

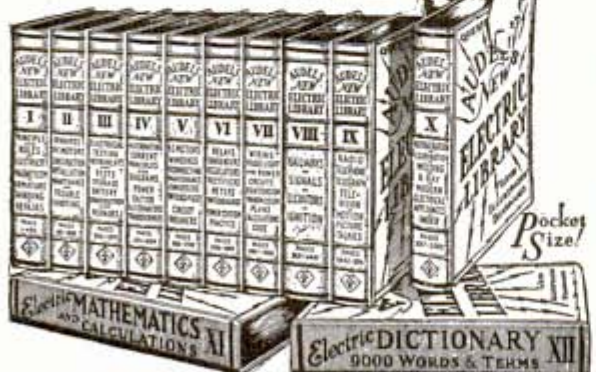

WHAT EVERY ELECTRICIAN WANTS TO KNOW!

Is easily found in AUDEL'S NEW ELECTRIC LIBRARY. Electricity made simple as ABC. Up-to-date, trade dope for the expert and ALL electrical workers. Questions, answers, diagrams, calculations, underwriter's codes; design, construction, operation and maintenance of modern electrical machines and appliances FULLY COVERED.

All available at small cost, easy terms. BOOK-A-MONTH service puts this NEW information in your hands for 6c a day. You can start your subscription with any volume. Write TODAY for electric Folder and FREE TRIAL offer.

THEO. AUDEL & CO., 49 W. 23rd St., New York City

Mail Vol. I, Electric Library on 7 days' free trial. If O. K. I will remit \$1.50, otherwise I will return it. I also request you to mail one book each month on same terms. No obligation unless I am satisfied.

Name.....
Address.....
Occupation.....PM

TRI-STATE COLLEGE

Degree in 2 1/4 years

B. S. Degree in Civil, Electrical, Mechanical, Chemical, Radio, Aeronautical Engineering; Business Administration, Accounting, Secretarial Science. Short diploma courses (36 weeks) in Surveying, Drafting. Special Preparatory Department for those who lack required high school work. Cosmopolitan student body. Approved by Civil Aeronautics Administration for flight training. Distinguished for 2 1/4-year technical courses (Non-essentials eliminated). 59th year. Tuition, living costs low. Defense needs call for engineers. Demand for graduates exceeds supply. Enter June, Sept., Jan., March. Catalog. 452 COLLEGE AVE., ANGOLA, IND.



ENGINEERING



FREE BOOKLET answers the many questions bound to be in your mind about where you stand in relation to the war—about how you can serve your country well, and still plan for a secure, successful future. It tells why YOU—by entering the aircraft industry—can be NECESSARY to your country's victory. For your free copy of this helpful booklet, airmail your request NOW to

AERO INDUSTRIES TECHNICAL INSTITUTE
3253 W. SAN FERNANDO RD., LOS ANGELES, CALIF.

AUTO-MECHANICS & WELDERS

Auto Mechanics and Welders are in big demand. Complete courses in arc and acetylene welding, body and fender bumping, spray painting and metal finishing. Pay after graduation plan. Special low rates. Write today.

MICHIGAN TRADE SCHOOL
3748 Woodward Ave. Detroit, Mich.

FREE
32 PAGE
CATALOG

GET THIS GREAT CATALOG OF MAGIC



Amazing tricks, mystifying and spooky stage and party illusions. Easy to do—no skill—perfect instructions. Fool your friends. Loads of fun. Add "life" to any party. 256 pages. 550 illustrations. Mail 50 cents for catalog, credited on your first order for \$3.00 or more.

NATIONAL MAGIC COMPANY
Studio 309, 119 S. State St., Chicago, Illinois

Learn CARTOONING

FREE TRIAL LESSON! Cash in on your sense of humor—AT HOME—BY MAIL. Have fun! Make money! No experience needed to start. Write today for FREE LESSON, mailed postpaid. No obligation.
MOON Gag-Cartoon School, Dept. F, Fall Creek, Wis.



5¢ LITTLE BLUE BOOKS

Send postcard for our free catalogue. Thousands of bargains. Address: HALDEMAN-JULIUS CO., Catalogue Dept., Desk M-861, GIRARD, KANSAS

MONEY IN RABBITS — CAVIES

WE BUY and put you in touch with other markets. Catalog and copy of magazine 10c. Or send 25c for Book Catalog and Price List and Year's Subscription to the AMERICAN SMALL STOCK FARMER. OUTDOOR ENTERPRISE CO., BV 919, PEARL RIVER, N. Y.

FREE TRIAL LESSON IN DRAFTING

More good jobs now in Drafting. Learn AT HOME in spare time (or at our Chicago School). Send postcard for FREE TRIAL LESSON and see how easy to learn and get a good job. CHICAGO TECHNICAL COLLEGE
E-203 Tech Bldg., 2000 S. Mich. Ave., Chicago, Ill.



HE Mailed This Coupon

J. G. O'BRIEN
Atlas Champion
Cup Winner

This is an ordinary snapshot of one of Charles Atlas' Californian pupils.

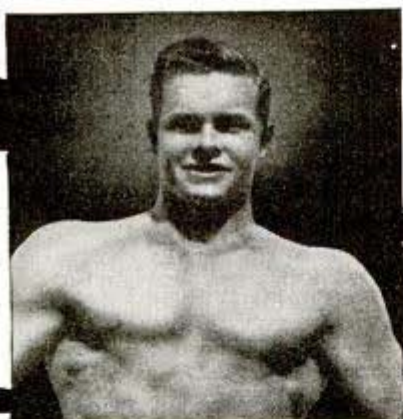

This is coupon O'Brien sent to get FREE Book. Yours is below—clip it NOW!

...and Here's the Handsome Prize-Winning Body I Gave Him!

J. G. O'BRIEN saw my coupon. He clipped and mailed it. He got my free book and followed my instructions. He became a New Man. NOW read what he says:

"Look at me NOW! 'Dynamic Tension' WORKS! I'm proud of the natural, easy way you have made me an 'Atlas Champion!'"

J. G. O'Brien.

"I'll prove that YOU, too, can be a NEW MAN"—Charles Atlas

I don't care how old or young you are, or how ashamed of your present physical condition you may be. If you can simply raise your arm and flex it I can add SOLID MUSCLE to your biceps—yes, on each arm—in double-quick time! Only 15 minutes a day—right in your own home—is all the time I ask of you! And there's no cost if I fail.

I can broaden your shoulders, strengthen your back, develop your whole muscular system INSIDE and OUTSIDE; I can add inches to your chest, give you a vise-like grip, make those legs of yours lithe and powerful. I can shoot new strength into your old backbone, exercise those inner organs, help you cram your body so full of pep, vigor and red-blooded vitality that you won't feel there's even "standing room" left for weakness and that lazy feeling! Before I get through with you I'll have your whole frame "measured" to a nice, new, beautiful suit of muscle!

Only 15 Minutes a Day

"Dynamic Tension!" That's the ticket! The identical natural method that I myself developed to change my body from the scrawny, skinny-chested weakling I was at 17 to my present super-man physique! Thousands of other fellows are becoming marvelous physical specimens—my way. I give you no gadgets or contraptions to fool with. You learn to develop your strength through "Dynamic Tension." You simply utilize the DORMANT muscle-power in your own God-given body—watch it increase and multiply double-quick into real, solid LIVE MUSCLE.

My method—"Dynamic Tension"—will turn the trick for you. No theory—every exercise is practical. And, man, so easy! Spend only 15 minutes a day in your own home. From the very start you'll be using my method of "Dynamic Tension" almost unconsciously every minute of the day—walking, bending over, etc.—to BUILD MUSCLE and VITALITY.

FREE BOOK "EVERLASTING HEALTH AND STRENGTH"

In it I talk to you in straight-from-the-shoulder language. Packed with inspirational pictures of myself and pupils—fellows who became NEW MEN in strength, my way. Let me show you what I helped THEM do. See what I can do for YOU! For a real thrill, send for this book today. AT ONCE. CHARLES ATLAS, Dept. 8-T, 115 E. 23rd St., New York City.



CHARLES ATLAS

An untouched photo of Charles Atlas, winner and holder of the title, "The World's Most Perfectly Developed Man."

CHARLES ATLAS

Dept. 8-T, 115 East 23rd Street, New York, N. Y.

I want the proof that your system of "Dynamic Tension" can help make me a New Man—give me a healthy, husky body and big muscle development. Send me your FREE book, "Everlasting Health and Strength." No obligation.

Name,

(Please print or write plainly)

Address,

City, State,

DRAFTSMEN NEEDED

Now



Industry is clamoring for more draftsmen for the job can't start until plans are drawn. Buildings, airplanes, machines, guns, tanks, bridges, all start on the drafting board, so it's no wonder that every good draftsman has a fine job. Yes, more draftsmen are needed NOW. The pay is good and the opportunities for advancement great.

Learn at Home in Spare Time

Begin now to turn spare hours into money. Be a draftsman, the connecting link between a mechanic and an engineer. Enjoy the wonderful opportunities for promotion that exist now. No experience or artistic talent is needed. You don't have to leave your present job while learning. Use spare time.

American School, Dept. DD545, Drexel Ave. at 58th St., Chicago, Ill.

Gentlemen: Send me FREE information covering special training in subjects checked below. No obligation on my part.

- | | |
|--|---|
| <input type="checkbox"/> Drafting and Design | <input type="checkbox"/> Diesel Engineering |
| <input type="checkbox"/> Accounting and Auditing | <input type="checkbox"/> High School Course |
| <input type="checkbox"/> Architecture and Building | <input type="checkbox"/> Liberal Arts |
| <input type="checkbox"/> Automotive Engineering | <input type="checkbox"/> Mechanical Engineering |
| <input type="checkbox"/> Business Management | <input type="checkbox"/> Radio and Television |
| <input type="checkbox"/> Aviation | <input type="checkbox"/> Business Law |
| <input type="checkbox"/> Electrical Engineering | <input type="checkbox"/> Retail Merchandising |

Name.....

Address.....

AUDELS BLUEPRINT READING

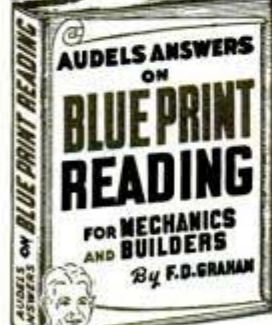

JUST OUT—FOR THE MAN WHO WORKS FROM BLUE PRINTS

"The Blue Print of Today is the Machine of Tomorrow." AUDELS ANSWERS ON BLUE PRINT READING covers All Types of plan reading including AIRCRAFT & SHIP BUILDING—tells How to Easily Understand Working Drawings.

What to look for first. Tells what each Line and each Symbol Means. The relation of one part to another. How to Understand Scales & Specifications. How to Make a Sketch. How to Make Blue Prints. A Key Book for Every Mechanic, Builder & Draughtsman—352 pages—It's New, Comprehensive, Fully Illustrated. Gives Short Cuts, Helps, Hints, Suggestions. Questions and Answers.

ASK TO SEE IT!
To get this assistance for yourself, simply fill in and mail coupon today. **\$2**

AUDEL, Publishers, 49 West 23rd St., New York
Please mail AUDELS BLUE PRINT READING (Price \$2). If satisfactory, I will remit \$2 on its safe arrival, otherwise I will return the book.

Name.....

Address.....

Occupation.....

Company..... PM

ARREST HIM, OFFICER! I'LL HAVE COMPLETE FACTS ON THE OTHER FELLOW TONIGHT!



Secret Service Operator No. 38 is on the job... FOLLOW HIM through all the excitement of his chase after the counterfeit gang. Write NOW for

FREE Confidential Reports No. 38 Made to His Chief!

It may open your eyes to the great opportunity for YOU as a well paid Finger Print Expert. The kind of work you'd like. Excitement! Travel! Thrills! A REGULAR MONTHLY salary. REWARD MONEY. Graduates of this school HEAD 43% of all Identification Bureaus in U. S. Write for Free Reports, Finger Print Book, low prices. Easy Terms Offer.

Literature will be sent only to persons stating their age.

INSTITUTE OF APPLIED SCIENCE
1920 Sunnyside Ave., Dept. 1355 Chicago, Illinois



LACO OIL BURNERS 18th Year!

Send for free folder and low prices on LACO's Nu-Comfort Room Oil Heater, Gravity and Forced-Air Furnaces, Gun-Type Burner for furnaces. Newly improved. Clean, quiet, automatic. Thousands of users, everywhere. **WRITE!**

LACO OIL BURNER CO., 125 Union Ave., Griswold, Iowa

Free WELDING



Welding offers immediate opportunities for better pay. Learn at home in spare time. Dynamic electric welder furnished for home use. Intensified shop training later. Also day and evening classes. Send for free trial lesson.

CHICAGO TECHNICAL COLLEGE
E-602, Tech Bldg., 2000 S. Mich. Ave., Chicago, Ill.

Correspondence Courses in RADIO and ELECTRICAL ENGINEERING LOW AS \$25

ELECTRICAL ENGINEERING. Get good grasp of wide electrical field. Modern. Very understandable. Theory made easy.
RADIO ENGINEERING. Extra fine course in radio, public address, photo-electric work. Trains you to be super-service man, real vacuum tube technician. Tuition ONLY \$25, plus material. Deferred payment plan. Experiment kits furnished.
FREE Write for free copies of school catalogs, student magazines, etc.
FREE LINCOLN ENGINEERING SCHOOL, Box 311-P-41, Lincoln, Neb.

Burn Your Name On Tools Electro Name Etcher Only

Protect valuable tools from thieves and tool borrowers! Electro Etcher BURNS your name, any design, permanently on tools, instruments, any metal. Easy! Simple as writing with pen or pencil. SEND NO MONEY! Rush order today. Pay postman only \$1.00 plus few cents postage on delivery. Use 5 days—money back if not delighted. Electro Name Etcher, Dept. D-600, Strader Ave., Cincinnati, O.

Short-Cut Mathematics COMBINED WITH Practical Mechanics Simplified

NEW 2-in-1 reading course! Now you can learn the speedy, simplified system of calculation used by draftsmen, engineers, accountants, "master minds" on the stage. Learn easy way to multiply 4 figures by 4 figures without using old-fashioned multiplication; add long columns of figures this lightning short-cut method. Learn horsepower, slide rule, micrometer, logarithms, wood measure, puzzles, etc. Large illustrated volume complete with answers, only \$1 postpaid. Satisfaction or refund. Amaze friends with your magic-like mental powers!

FREE Complete details... mail coupon TODAY!

NELSON CO., 500 Sherman St., Dept. E300, Chicago
Please send free details about "Short-Cut Mathematics and Practical Mechanics Simplified." No obligation.

Name.....

Address.....



INVENTORS

Get Expert Advice on HOW to PROTECT and SELL Your Invention

Get FREE COPY

"Why I thought of that years ago!" How many persons have said that, when they found later that somebody else had thought of the same thing, had it patented, sold it, and were profiting from it? Too many, sad to say. These unfortunates did not know what to do about their inventions, in order to protect and profit from them. Some thought elaborate working models were necessary to secure a patent—others felt their idea wasn't "worth much." They failed to realize that a good practical invention, plus prompt action in securing a Patent, and locating a buyer or a good market, have proved the secrets of success for thousands of inventors.

Patent Guide Shows What To Do

Our "Patent Guide for the Inventor" answers many important questions concerning Patents that inventors constantly ask. It tells what facts, details, drawings, sketches, etc. are necessary to apply for a Patent; how to protect your invention through dated and witnessed disclosure; how to do this AT ONCE to safeguard your rights; how Patent Office Records can be checked to determine whether the invention is probably patentable before filing fees need be paid; discusses costs involved and a practical way these can be paid as the application progresses. It tells how some inventors secured financial backing; how many simple inventions have proved large commercial successes; how Patents covering improvements also can be profitably utilized and marketed; tells countless other facts of interest.

Why You Need Expert Assistance

The Patent Laws were enacted for your benefit—to give you protection for the features of your invention which are Patentable. But these features must be legally and concisely set forth in the form of "claims." This phase of the procedure is so complex that the Patent Office advises the Inventor to engage a competent Registered Patent Attorney. We maintain a large staff—carefully trained registered patent attorneys—expert draftsmen—experienced searchers—to serve you. We have been serving inventors for more than 20 years.

Take First Step Now

With the Patent Guide you will receive also Free a "Record of Invention" form which will enable you at once to establish the date of your invention, before you file your Patent application. This step costs you nothing yet may be vital to your success. Remember—in Patent Matters, ACTION IS IMPORTANT. Delay can be costly. Mail the coupon in an envelope, or paste it on a penny postcard NOW.

CLARENCE A. O'BRIEN
and
HARVEY B. JACOBSON
"Worthy of Your Trust"
Registered Patent Attorneys
21-E Adams Building
Washington, D. C.

Get This
FREE BOOK

IMMEDIATELY MAIL COUPON TODAY!



CLARENCE A. O'BRIEN
and **HARVEY B. JACOBSON**

CLARENCE A. O'BRIEN AND HARVEY B. JACOBSON
Registered Patent Attorneys before the United States Patent Office
21-E Adams Building, Washington, D. C.

Please send me your 48-Page "Patent Guide for the Inventor" and your specially prepared "Record of Invention" form FREE. This request does not obligate me.

Name

Address

City..... State.....

(Please write or print plainly.)

POPULAR INVENTIONS

For Your Home

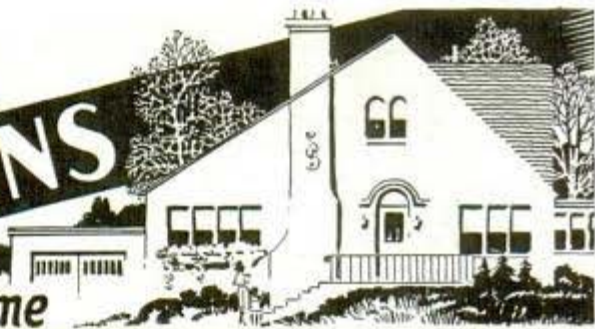

Swinging Blackout Lamp Always Stays Upright



Using a candle protected by a glass chimney, a blackout lamp now on the market always assumes a vertical position though the bearer may tilt the handle or the lamp may rest on an inclined surface. The handle by which it is carried may also be used as a hook for hanging the lamp on a wall.

Measuring Cup on Spoon Handle Feeds Flavoring as You Stir

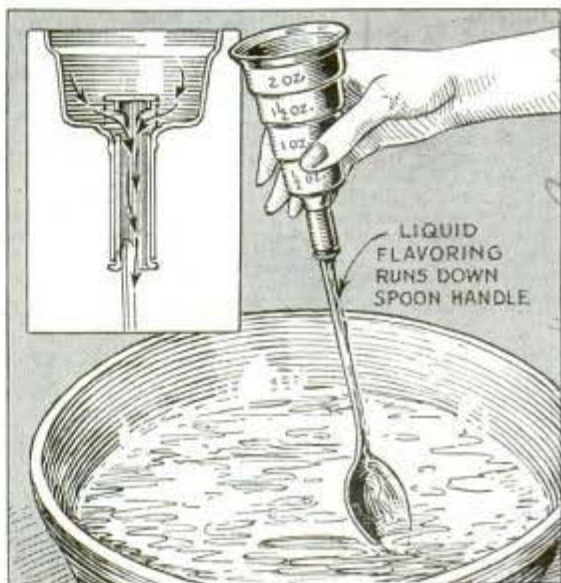

For stirring flavoring gradually into puddings and other tasty dishes, an automatic flavoring spoon is now available. The flavoring is stored in a two-ounce cup atop the spoon handle, and a downward pressure on the cup releases the contents in small amounts, permitting it to run down the handle and into the bowl.

Illuminated Heating-Pad Switch

Adjustment to 30 different degrees of heat is made possible for a heating pad equipped with an illuminated dial switch. A light within the heat-control switch permits selection of the desired temperature in the dark.

Note Lite switch



WHERE-TO-BUY-IT INDEX OF POPULAR INVENTIONS

- Blackout lamp**
Oxford Metal Spinning Co., 2102 E. Gillingham St., Philadelphia, Pa.
- Illuminated heating-pad switch**
Neaco Products Co., Bridgeport, Conn.
- Flavoring cup on spoon handle**
Spaulding-Gorham Co., Drake Hotel, Chicago

Oxford Metal Spinning Co. / Philadelphia, Pa. 2102 E. Gillingham St.

Neaco Products Co. / Bridgeport, Conn.

Spaulding-Gorham Co. / Drake Hotel, Chicago

Cascomate pad - about 83¢

LAW

LEARN AT HOME

Are you adult, alert, ambitious, willing to study? Investigate LAW! We guide you step by step—furnish all texts, including 14-volume Law Library. Training prepared by leading law professors and given by members of bar. Degree of LL.B. conferred. Low cost, easy terms. Send NOW for Free, 48-page "Law Training for Leadership."

LASALLE EXTENSION UNIVERSITY
A CORRESPONDENCE INSTITUTION
DEPT. 564-L CHICAGO

ELECTRICITY MEN NEEDED

Electricians are needed everywhere. Hollywood studios alone claim shortage 200 men. This is a live money making profession. Learn at home, spare time. Easy payments. Selective Employment service. Write for FREE Bulletin. No obligation.

AMERICAN SCHOOL

Dept. EE545

Drexel at 58 St., Chicago

get the fascinating story of PLASTICS without cost or obligation

See the important place of plastics in virtually every industry—in War as well as Peace. Learn what a knowledge of plastics can mean to your future career. Write today for interesting, illustrated literature.

PLASTICS INDUSTRIES TECHNICAL INSTITUTE

37-27 Queens Blvd.
LONG ISLAND CITY, NEW YORK

517 S. Western Avenue
CHICAGO, ILLINOIS

190 S. Alvarado Street
LOS ANGELES, CALIFORNIA

PRACTICAL RADIO INFORMATION

Including Frequency Modulation—Television, etc.

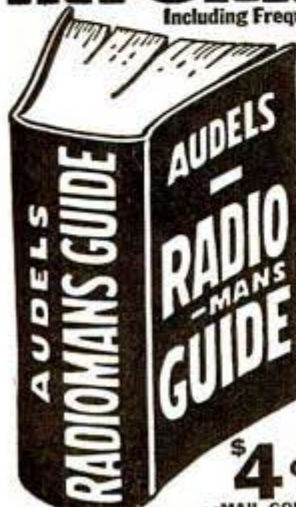

Inside Information for all Servicemen—Aircraft Pilots, Students, 772 PAGES, 400 DIAGRAMS is complete—gives Authentic Principles & Practices in Construction, Operation, Service & Repairs. Covers clearly and concisely Radio fundamentals—Ohm's Law—Physics of sound as related to radio science—Measuring instruments—Power supply—Resistors—Inductors—Condensers—Transformers and examples—Broadcasting stations—Radio Telephony—Receivers—Diagrams—Construction—Control systems—Loud speakers—Antennas—Auto Radio—Phonograph pickups—Public Address Systems—Aircraft & Marine Radio—Radio Compass—Beacons—Automatic Radio Alarms—Short Wave—Coil Calculations—Testing—Cathode ray oscillographs—Static Elimination—Trouble Pointers—Underwriter's standards—Units & tables. REVIEW QUESTIONS—Ready Reference Index.

\$4 COMPLETE • PAY \$1 A MO.
To get this practical information in handy form—Fill in and

MAIL COUPON TODAY

AUDEL Publishers: 49 West 23rd St., New York
Mail AUDELS NEW RADIOMAN'S GUIDE for free examination. If O. K. I will send you \$1 in 7 days; then remit \$1 monthly until \$4 is paid. Otherwise I will return it.

Name _____
Address _____
Occupation _____
Reference _____ P. M.

AUTO MECHANICS!

AMAZING NEW BOOK
SHOWS YOU HOW TO

REPAIR ANY MAKE CAR—

TODAY!



Helps EVERY Mechanic—even experts—do repair jobs easier, quicker
Explains every auto repair operation STEP-BY-STEP. Easy-to-use! Hundreds of photographs, diagrams, drawings, show exact "how to do it" of repairs, adjustments, replacements. All jobs on every model since 1935—plus 405 truck models! Engine; Electric, Fuel, Cooling, Lubrication Systems; Clutch, Transmission; Universals; Rear End; Wheels, Brakes; Knee Action, Shock Absorbers, Springs; Body; Free Wheel, Overdrive, Fluid Coupling!

Explains Every Repair Job on Every Model of All These Cars—1935 through 1942!

- | | |
|-----------|--------------|
| American | La Salle |
| Bantam | Lincoln |
| Auburn | Lincoln |
| Austin | Zephyr |
| Buick | Mercury |
| Cadillac | Nash |
| Chevrolet | Oldsmobile |
| Chrysler | Overland |
| Cord | Packard |
| De Soto | Pierce Arrow |
| Dodge | Plymouth |
| Ford | Pontiac |
| Graham | Reo |
| Hudson | Studebaker |
| Hupmobile | Terraplane |
| Lafayette | Willis |

And major data needed to service 405 models of trucks Nearly 200,000 Vital Facts on Every Phase of Tune-Up and Repair • Over 450 Charts, Tables • More than 900 Photos, Drawings, Diagrams • Over 600 Big Pages—Size 8 1/4 x 11 inches.

Published by MoToR, the Leading Automotive Business Magazine, 572 Madison Ave., New York, N. Y.

150 FACTORY BOOKS IN ONE!
Imagine a COMPLETE COLLECTION of ALL official shop procedure manuals, prepared by each car manufacturer's own engineers! That's what you GET in this book! Open the manual to the car you want—you'll find everything to show the right way to do the job.

AUTO MECHANICS INSTRUCTORS AND STUDENTS:
This is the factory shop manual used by the U. S. Army, trade, technical, and vocational schools for training auto mechanics.

SEND NO MONEY
Simply fill out coupon. Mail it TODAY. Your copy of MoToR's 1942 FACTORY SHOP MANUAL will be sent at once. When postman delivers, deposit only \$4.00 (plus few cents C.O.D.) See Iron-Clad Guarantee in coupon.

7 DAY TRIAL

MoToR BOOK DEPT., Room 511, 572 Madison Ave., New York, N. Y.

Rush me MoToR's 1942 Factory Shop Manual. I will pay postman \$4 plus few cents postage, on delivery. Unless fully satisfied, I may return Manual within 7 days for full refund. (Foreign Price \$6, cash with order.)

NAME _____ JOB _____

ADDRESS _____

CITY _____ STATE _____

Put X here if enclosing \$4 (check, money order) WITH this coupon. WE will then pay all postage. Same Guarantee.

Say you saw it in Popular Mechanics!



Increased production
means



More Jobs for MACHINISTS and bigger pay for men who know their work

This home-study course gives you the practical facts on modern machines, up-to-date methods, you need to advance in machine shop work. Take advantage of the other man's experience as found in books, to solve your problems, increase your efficiency, with

The AMERICAN MACHINISTS' LIBRARY

6 volumes—2368 pages—2516 illustrations
(A combined home-study course and reference library)

This library of machine shop practice was written for practical men. It gives you the best methods for every kind of machine shop work. It fully explains lathes, drills, and other machine tools and their operation, automatic screw machines, speeds and feeds, gear design and production, jigs and fixtures, punch and die work, metal surfacing, etc., etc. Plainly written—completely illustrated—the best kind of help to the machine shop man who wants to advance himself.

No money down—special price—easy payments.

EXAMINATION COUPON

McGraw-Hill Book Co., 330 W. 42nd St., New York

Send me for ten days' examination the American Machinists' Library. If satisfactory I will send you \$1.50 in 10 days and \$3.00 monthly until the price of \$19.50 is paid. If not wanted, I will return the books postpaid. (To insure prompt shipment write plainly and fill in all lines.)

Name.....
Home Address.....
City and State.....
Position.....
Name of Company..... PM-5-42

You Can
Learn To

Be an ARTIST



Trained Artists are capable of earning \$30, \$50, \$75 a week! Now is the time to prepare for a pleasant, profitable Art career. Our proven, practical method prepares you step by step at home in your spare time. **COMMERCIAL ART, ILLUSTRATING, CARTOONING** all in ONE complete course, 2 Art Outfits furnished. Mail coupon for FREE BOOK, "Art for Pleasure & Profit". Explains our course of training and commercial opportunities in Art. Write today.

FREE BOOK gives details!

Washington School of Art, Studio 125A
1115—15th St., N. W., Washington, D. C.

Name..... Age.....
Address.....
City..... State.....

TRAVEL FOR "UNCLE SAM"



City and Rural Carriers—Postoffice Clerks—
Inspectors — Accountants — Stenographers
—Typists—Many other Government Jobs

AMAZING NEW ELECTRIC ARC WELDER

RETAILS ONLY
\$2.95
COMPLETE

FULLY GUARANTEED

PLUGS INTO LIGHT SOCKET

Amazing new HANDIWELD Electric Arc Welder—operates from 110 volt A.C. or D.C. same as other arc welders higher priced—generates tremendous heat to weld all kinds of metal. Not a toy welder that uses carbons, but actually uses standard coated rods—sizes 1/16" and 3/32". Generous supply furnished with welder. Guaranteed not to burn out. Repairs fenders, auto bodies, radiators, pre-heated small castings and machinery parts. Take HANDIWELD anywhere to job, operate from light socket. Sturdily built of finest materials to last years. Fully guaranteed by Big Manufacturer.

SEND NO MONEY! You'll find a thousand uses for the HANDIWELD around your home, garage, work shop. Also by garages, factories, repair shops, mechanics, farmers, inventors, linemen, plumbers, etc. Order HANDIWELD now. Send no money. We'll rush one to you complete with rods and goggles. Pay postman only \$2.95 plus few cents postage. If not delighted, return HANDIWELD in 5 days from receipt and money paid for it will be refunded instantly. Rush your order now.

KUMFY PRODUCTS INC., Dept. F-202 Cincinnati, Ohio

TRAIN FOR Radio IN 8 WEEKS

BY SHOP WORK
I'll Finance Your Training

Prepare for jobs in Radio, by 8 weeks practical shop training in Coyne Shops. Free Employment Service. Many earn while learning. You don't need previous experience or a lot of book learning. Write for BIG FREE RADIO BOOK, and my "Pay-Tuition-After-Graduation" Plan.

H. C. LEWIS, Pres., RADIO DIV., Coyne Electrical School
500 S. Paulina Street Dept. 52-3H Chicago, Illinois

MAKE MONEY

Learn Portrait Painting at Home by the NEW, Easy Stuart System
• Previous art training or talent NOT necessary. This Stuart System is radically new and simple. It will REALLY TEACH PORTRAIT PAINTING. Coat is unusually low. Write today for free booklet how YOU can start your career NOW! Address:

STUART STUDIOS, Dept. F
121 Monument Circle Indianapolis, Indiana

Learn TOOL DESIGN

Qualify quickly as a Machine or Tool Designer by home study in spare time. Entire defense program depends largely upon the machine and tool designer. After defense boom, machine and tool designers will be equally necessary for reconstruction. Many now making \$100 to \$125 a WEEK. Rapidly expanding industry calling for more machine and tool designers than now available. Learn quickly with our step-by-step lessons supervised by a recognized professor of machine tool design. Rush name and address today for complete facts on Machine or Tool Design. Learn what these fields offer you and how quickly you can qualify for a big pay position. No obligation. State age. A penny postal will do—but hurry.

Ohio Institute of Technology, Box 57, Greenville, Ohio



To make money on your idea..

PROTECT your INVENTION

WITH A UNITED STATES GOVERNMENT

PATENT!



YOU want to protect and cash in quickly on that original idea you have . . . your own invention! Both the U. S. Supreme Court and the Patent Office have made it clear that you need the assistance of a competent patent attorney to safeguard your chances for success. Victor J. Evans & Company has helped thousands of inventors . . . creative-minded men like you, who have entrusted their ideas to our specialized knowledge for the past 44 years. Every case that comes into this office is PREPARED IN STRICTEST CONFIDENCE by a REGISTERED PATENT ATTORNEY experienced in the art to which the invention appertains. A good strong patent is your solid foundation upon which to build commercial success.

YOUR IDEA MAY HAVE GREAT COMMERCIAL POSSIBILITIES

There never was a time in the history of this country when creative-minded inventors had a greater opportunity than they have right now. Manufacturers are eager for improvements on production machinery; the U. S. Government has appealed to American inventors for new ideas and devices to be used for National Defense; business men are keen for new inventions or practical changes in devices now in use for immediate sale or for post-war exploitation. Your idea may be "just the thing".

HOW WE CAN HELP YOU!

The first thing for you to do is to find out (without its costing you one penny) how U. S. Patent Laws protect you—what steps to take so that you can safely commercialize your idea. Our two advisory books illustrated below tell you clearly just what to do immediately. They tell you the kind of sketch or model needed; the importance of quick action;

how to sell your invention; how to secure financial backing. These are your reliable text books on patent matters; don't be without them another day. They ILLUSTRATE 115 MECHANICAL MOVEMENTS—picture and describe many other details of great interest to inventors. Make your start now—before tonight. Mail coupon below for BOTH BOOKS and all-important EVIDENCE OF INVENTION form.

SEND FOR THE BOOKLETS and EVIDENCE OF INVENTION FORM Right Now . . . While the thought is fresh in your mind!

NEW PATENT PLANNING COMMISSION FOR POST WAR NEEDS

Bulletin recently issued by Hon. Jesse Jones, Secretary of Commerce, announces creation by the President of a Patent Planning Commission composed of experienced engineers and manufacturers. Should be hailed as a god-send by American inventors. Quoting from the bulletin:

"The object of the Patent Planning Commission should be to create a reservoir of new products, or improvements upon existing ones, to which industry could apply its force when arms, ammunition and other martial supplies cease to be our primary productive aim."



68 pages of facts for INVENTORS

... and the important Evidence of Invention Form!

COUPON BRINGS YOU THESE 2 BOOKS FREE!

VICTOR J. EVANS & Co.

Merlin M. Evans

REGISTERED PATENT ATTORNEYS

MAIN OFFICE, 630-E VICTOR BUILDING WASHINGTON, D. C.

Pittsburgh Office: 521-N Empire Building Los Angeles Office: 738-N Security Building

Rush by return mail. Free copies of your books "Patent Protection" and "When and How to Sell an Invention"—also important "Evidence of Invention" Form.

Name

Address

City and State

WEBSTER'S COLLEGIATE

FIFTH EDITION



110,000
ENTRIES
1,800
ILLUSTRATIONS

The Best Handy-Sized Dictionary

because it defines all the most commonly used words, selected from WEBSTER'S NEW INTERNATIONAL DICTIONARY, Second Edition—the "Supreme Authority" in courts, schools, editorial offices—and is edited with the same careful scholarship. 1,300 pages; \$3.50 to \$8.75, depending on bindings. At your bookdealer, or order from the publishers. New Quiz and Picture Game sent FREE. G. & C. MERRIAM CO., 902 Federal St., Springfield, Mass.

ELECTRICAL BOOKS

shipped FREE

10 BIG BOOKS

FOR EXAMINATION
MODERN
ELECTRICITY
INCLUDING RADIO
AND TELEVISION

Here's great news for anybody interested in Electricity. NEW 17th. edition of Applied Electricity brought right down to date with NEW Electrical subjects fully covered. 10 big Volumes and all shipped FREE for examination.

For
Beginners
and Experts

over 3000 pages—hundreds of illustrations—the most complete work of its kind we have ever published. Dynamos, motors, power stations, Radios, television, everything electrical explained so anyone can understand it.

BIG FIELD! Big Demand! Big Pay! Men who understand electricity are urgently needed in thousands of industries. Autos, airplanes, machine shops—practically every industry depends on electricity and men who know this subject make big money. Pleasant, fascinating work, easy to learn and do; learn with these books. Send coupon for a set for FREE examination and see for yourself.

SEND NOW

A year's consulting privileges with our engineers now given to all buyers of this famous Cyclopedia of Electricity.

AMERICAN TECHNICAL SOCIETY
(Publishers—Home Study Courses)

American Technical Society, Dept. E519, Drexel at 58th St., Chicago
Send for 10 days' free use, 10 volume set of Applied Electricity. You also agree to send me a certificate entitling me to consulting privileges for one year. I will pay the delivery charges only on the books. If I wish I may return them in 10 days and owe you nothing, but if I keep them, I will send \$2.00 after 10 days, then \$3.00 a month until the total price of only \$29.80 is paid.

NAME.....
ADDRESS.....

CITY..... STATE.....

Please attach letter stating age, occupation and name and address of employer and give at least one business man as reference.



YOU CAN FIX IT

This Book Tells You What To Do When any one of 1001 things go wrong in your home. **\$1**
FORMERLY \$2.50, Now

You can fix everything about your house and everything in it—this complete, practical encyclopedia of home and household repairs tells you how. You save the cost of the book dozens of times every year.

Every repair from the roof to your basement, from your heating system to your electric iron is clearly, fully explained in non-technical language. 5-day money-back guarantee. 480 pages crammed full of advice and directions. Formerly \$2.50, now only \$1.00 Will mail C.O.D., or send \$1 to

FRANKLIN BOOKS 110 N. FRANKLIN STREET CHICAGO

Free Book

MOUNT BIRDS, ANIMALS, FISH
Yes FREE. Explains Taxidermy. Tells how to learn at home by mail to mount birds, animals, heads, to TAN skins and furs. Great for MEN and BOYS. Fun! Also earn money in spare time. WRITE TODAY—NOW—for free book containing 100 game pictures. State AGE, N.W. School of Taxidermy, Dept. 3375, Omaha, Neb.



\$\$\$ IN MOVIE WRITING!

Put your ideas into writing—and CASH! WRITE TODAY FOR FREE DETAILS. BRET CIPES 240 Fifth Avenue NEW YORK

BE A CRIME SPECIALIST

Our books on cryptography, forgery, handwriting, fingerprints, identification, investigation etc. will be of great help in your study of the fascinating subject of crime. Send 5c in stamps or coin for our list of selected books.

ACME BOOK SERVICE, Room 54
289 Fourth Ave. New York City

POP VICTORY

BUY UNITED STATES DEFENSE BONDS AND STAMPS

LAW

STUDY AT HOME for PERSONAL SUCCESS and LARGER EARNINGS. 31 years expert instruction—over 106,000 students enrolled. LL.B. Degree awarded. All texts furnished. Easy payments. Send for FREE BOOK!

AMERICAN EXTENSION SCHOOL OF LAW
Dept. 17-M, 8 East Huron St., Chicago, Ill.

Learn PROFITABLE PHOTOGRAPHY

Modern, practical training. You "learn by doing." For pleasure or career. Unusual wartime opportunities. Black & White, Motion Picture, or Color photography. 32nd year. Free Booklet.

NEW YORK INSTITUTE OF PHOTOGRAPHY
10 West 33 St. (Dept. 49) New York City

RADIO HINTS FREE

Practical, 32 page lesson on service hints, diagrams, testing methods. Get your start in radio, learn important radio facts. Write today for your copy. Send 3c stamp for postage.

SUPREME PUBLICATIONS, 328 SO. JEFFERSON ST., CHICAGO, ILL.

America Needs Men Trained for TOOL & DIE MAKING, MACHINIST & SCREW MACHINE TRADES

HARRY LEBESON PRESIDENT & FOUNDER

ALLIED School offers you short intensive, Practical training courses in Our fully equipped Shops. Learn on Actual Jobs! State Approved. Learn Days or Evenings. Enter anytime. FREE Employment Service and opportunity to earn while learning. Write for FREE Book "Practical Machine Shop Training."

ALLIED SCREW MACHINE CO., (School Division)
609 West Lake Street, Dept. PM-5, Chicago, Illinois

SPRAYBERRY RADIO TRAINING

Includes FULL EQUIPMENT!



Experience Easily Acquired at Home

You Do Practice-Giving Experiments
Many Special Features . . .

ALL Designed To Help You Make Fast Progress
SPRAYBERRY Training starts right at the beginning of Radio . . . unfolds each subject in a simplified, logical, understandable style. You easily learn Television, Frequency Modulation, Signal Tracing, Mobile Radio (Auto-Tank), Aviation Radio, Electronics, Facsimile Radio, Radio Set Repair and Installation work.

TRAINING PREPARES YOU FOR A BUSINESS OF YOUR OWN . . . OR GOOD RADIO JOBS AT EXCELLENT PAY

The great fascinating and progressive field of Radio offers many opportunities to the man who wants to get ahead. My Training is designed to give you quick access to those opportunities. SPRAYBERRY Methods are thorough and practical. Your Training will not interfere with your present work.

NO PREVIOUS EXPERIENCE NEEDED

It makes no difference what your education has been. I can fit you quickly for a good-paying Radio job. I make it easy for you to grasp Radio principles and remember them. Your success is my full responsibility.

YOU GET PROFESSIONAL TEST EQUIPMENT PLUS COMPLETE RADIO SET

With the Radio Parts given (everything needed to build a Complete Receiver) . . . you conduct interesting informative experiments with your own hands. Also you are supplied a modern TESTER-ANALYZER.

EARN WHILE YOU LEARN

My BUSINESS BUILDERS show you how to put your equipment to actual use in handling Money-making Radio Service Jobs shortly after you begin Training.

THE SPRAYBERRY COURSE IS SOLD UNDER MONEY-BACK AGREEMENT

FULL RADIO SET



TESTER-ANALYZER



HOW TO MAKE MONEY IN RADIO



RUSH COUPON for BIG FREE BOOK

SPRAYBERRY ACADEMY OF RADIO, F. L. Sprayberry, President
310-E University Place, N. W., Washington, D. C.

Please rush my FREE copy of "HOW TO MAKE MONEY IN RADIO."

Name Age

Address

City State

Mail in envelope or paste on penny postcard

Get this Handy OHMITE

Ohm's Law Calculator!

10¢



Solves any Ohm's Law Problem with One Setting of the Slide!

Simple! Easy! Complete! Requires no slide rule knowledge. All values are direct reading.

Scales on two sides cover the range of currents, resistances, wattages and voltages commonly used in Radio and Electrical work. Size 4 1/8" x 9". Send only 10c in coin to cover cost of handling.

OHMITE MFG. CO., 4930 Flournoy St., Chicago, Ill.

MOTORISTS Wanted!



TO MAKE THIS UNIQUE GAS SAVING TEST

Will you permit us to send you at our risk the Vacu-matic, a device which auto owners everywhere are praising? Install it on your car. Test it at our risk. Unless it trims dollars off your gas bills by saving up to 30% on gasoline consumption, gives more power, quicker pickup and faster acceleration, the test will cost you nothing.

Automatic Supercharge Principle

Vacu-matic is entirely different! It operates on the supercharge principle by automatically adding a charge of extra oxygen, drawn free from the outer air into the heart of the gas mixture. It is entirely automatic and allows the motor to "breathe" at the correct time, opening and closing as required. Saves up to 30% on gas costs, with better motor performance.

AGENTS Get Yours FREE

FOR INTRODUCING. Here's a splendid opportunity for unusual sales and profits. Every car, truck, tractor owner a prospect. Send name and address now for big money making offer and how you can get yours FREE. The Vacu-matic Co., 7617-944 W. State Street, Wauwatosa, Wis.

AIRCRAFT Designing & Engineering



HOME STUDY AFFILIATE OF RYAN SCHOOL OF AERONAUTICS

You can learn to design airplanes. A Ryan Home Study Course in Aeronautical Engineering will prepare you quicker for a job with good pay and a future. Easy to understand. No previous training necessary. Write today for free literature.

RYAN AERONAUTICAL INSTITUTE
425 Lindbergh Field • San Diego, California



Complete Plans and Building Instructions, 70c

FREE TRAILER PARTS CATALOG

We'll save you money on—axles, springs, wheels, couplers, windows, sinks, water pumps, brakes, refrigerators, beds, lamps, inside and out, 6V lamps, furniture, jacks—everything. Special discount to mfrs. NATIONAL TRAILER EQUIPMENT CO. Successors to Kar-A-Van Industries, Inc. Dept. P. 714 W. Wisconsin Ave., Milwaukee, Wis.

AMAZING CHEAP OIL BURNER

Sweeping the Country!!

COOK and HEAT Without Coal or Wood

In Your Present Stove or Furnace — No Drudgery, Dirt or Ashes — Clean Heat at SMALL COST.



OVER 40,000 SOLD

Beats any cheap burner ever gotten out for lowest, efficient performance. Burns ordinary low priced fire flowing oil without re-generating or clogging up. Heat regulated by Turn of Valve.

30 DAYS' TRIAL

Prove its efficiency, convenience and economical operation without risk. A Guarantee with each burner. Write immediately for SPECIAL OFFER TO AGENTS who will demonstrate and take orders. Write quick, be first to learn how to make REAL MONEY right now, spare or full time—mail to postcard today.

United Factories, E-751, Factory Bldg., Kansas City, Mo.

AGENTS Salesmen BIG MONEY F. Silver says: "I can dispose of 250 HEAT KINGS before this year ends." Write us now for agents' offer.



GENUINE GRANITE or Marble, \$10.95 UP. Order Direct By Mail and save. Don't wait. U. S. MARBLE & GRANITE CO., A-18, Oneco, Fla.

BIG FREE CATALOG

Freight Paid anywhere in U.S.A. Lettered, Guaranteed, Free Catalog & samples of stone.

LEARN A BIG PAY TRADE MAIL COUPON!

in 2 to 8 WEEKS!

We Pay Room and Board

To meet the great demand for men at high wages, we have inaugurated intensive training courses in the trades listed here. Learn in 2 to 8 weeks by actual shop work. One of America's leading schools. Established 1902. 7 floors of shops. Many employers send their young men here for intensive training. Free employment service.

GREER SHOP TRAINING

Dept. 252, 2024 S. Wabash Ave., Chicago, Ill.

Send "Shop Training Facts" describing trade checked below:

Auto-Diesel
 Welding
 Refrigeration and Air Conditioning

Body-Fender Machine Shop
 Tool and Die
 Aviation

Name
Address
Age

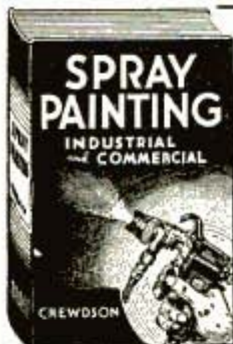

OPERATORS NEEDED

Make Big Money—Learn at Home

This book gives you detailed instructions for industrial and commercial spray painting, sign work and interior decoration. Full information on pigments, thinners, varnishes, techniques, spray guns of all types, fancy finishes, with a section on NATIONAL DEFENSE work. Easy to understand. Cloth bound—125 pages—fully illus. Only \$1.50. Postage prepaid if cash in advance.

ORDER TODAY.

FRED'K J. DRAKE & CO.
624 W. Van Buren St., Chicago, Ill.

INVENTORS

This **BOOK**

and **INVENTION RECORD (Cost You Nothing) FREE BOOK**



42nd YEAR ENGINEERING DEFENSE COURSES

Short, intensive Defense courses in Aircraft, Sheet Metal, Mechanical, Structural, Architectural Drafting; Electricity; Power Plant; Arc, Aircraft Welding. One and Two-Year courses in Aeronautical, Electrical, Mechanical, Structural, Architectural, Civil Engineering. B.S. Degree 3 Yrs. Low tuition and living costs. Part-time work for room and board. Thousands successful graduates. Extensive equipment. Theory and practice. Non-essentials omitted. No home study courses. Catalog free.

FINLAY ENGINEERING COLLEGE
1001 Indiana Ave. Kansas City, Mo.

STUDY AT HOME

With A Chartered Educational Institution
Courses in Arts; Sciences; Philosophy; Education; Public Health; Medical Jurisprudence; Psychology; Sociology; Physics; Chemistry; Geology; Pol. Science; Theology; Law; Business Training; Accounting; Mathematics; Statistics; Agriculture. ENGINEERING, Electrical, Civil, Mechanical, Drafting, Architectural, Steam, Aeronautical, Radio, Structural, Industrial, Highway, Petroleum, Mining, Marine, Chemical.
McKinley-Roosevelt Incorporated, 4610-UD, Sheridan Road, Chicago

THERE'S MONEY IN CARTOONS!

RAYE BURNS will teach you HOW to CREATE ORIGINAL CARTOONS at Home that you may SELL. Course contains 26 lessons and over 600 Illustrations. All for Only \$2.85
Send name and address for free details.

RAYE BURNS SCHOOL, Dept. M, Box 3583, CLEVELAND, OHIO

Learn AUTO-DIESEL or RADIO-TELEVISION

Oldest, largest Trade School in West trains you for top pay jobs. Flexible, proven plan to meet your individual needs. Transportation allowed to L.A. Earn room, board while learning. Request Catalog. Dept. PMA-5.

NATIONAL SCHOOLS - Los Angeles

Always write your name and full address clearly when answering advertisements.

ELECTRICITY

"LEARN BY DOING" in 12 weeks I'LL FINANCE YOUR TRAINING!

Get ready now for a good job in Electricity. My Big Free Book tells you how we train you in 12 weeks, by actual shop work on real electrical machinery—not by books or correspondence. Amazing plan enables you to get training first... then take 12 Months to pay in small monthly payments starting 60 days after graduation. Experience or advanced education not needed. Many Earn While Learning. Free lifetime employment service. Radio, Electric Refrigeration and Air Conditioning instruction included. MAIL COUPON for FREE BOOK and all facts.

H. C. LEWIS, Pres., COYNE ELECTRICAL SCHOOL
500 South Paulina Street, Dept. 52-72, Chicago, Illinois
Send free book with Facts on Coyne, the Pay After Graduation plan, and extra 4 weeks Radio course now included.

NAME _____
ADDRESS _____
CITY _____ STATE _____

"HOW TO PROTECT, FINANCE and SELL YOUR INVENTION"

Our FREE BOOK and other literature available to our clients—gives you complete details on how to "ready" your invention for money-making. It tells you how others did it—who they went to for finances—how they arranged partnerships—how they made contacts with manufacturers—how they dictated royalty arrangements—how much money they made—how you can find a market. Our new FREE BOOK discloses sources of quick revenue if your invention is patentable and saleable with profit possibilities.

"THE FIRST STEP"

The first step in getting your invention ready for market is to make a dated record of it on our "Invention Record" Form. This Form properly filled out and witnessed will be invaluable to you later in establishing the date of your invention should need for such evidence arise. We will be glad to send you our "Invention Record" and have it witnessed in this office when you return it with disclosure of your device. This service costs you nothing—and it immediately puts you on record as the originator of your device.

"PROTECT YOUR INVENTION NOW!"

We have many letters in our files from manufacturers requesting inventions. Today's demand for new devices is tremendous—added to by emergency needs. Protect your invention now with a U. S. Patent. By acting promptly you may prevent another inventor getting in ahead of you at the Patent Office here in Washington. The first step is to make a sketch and description of your invention on our "Invention Record", have it witnessed and mail it to us. We will then make a Search of the U. S. Patent Office files to ascertain whether we can get patent protection for you. This is a step you should make NOW—before another steps in ahead of you and walks away with a patent.

"HOW WE CAN HELP YOU"

Get full facts now—another inventor getting ahead of you with patent may mean you lose all! Mail coupon today—a 3c stamp may lift your present income to early future security!

McMORROW & BERMAN

REGISTERED PATENT ATTORNEYS BEFORE U.S. PATENT OFFICE
135-Z Barrister Building
Washington, D. C.

Send me your NEW FREE Book "How To Protect, Finance and Sell Your Invention" and specially prepared "Invention Record" form at once. I understand that this request does not obligate me.

NAME
ADDRESS
CITY STATE
Write or Print Name Clearly

PATENTS

Booklet Free Highest References
Promptness Assured Best Results

Send drawing or model.

ALL BUSINESS GIVEN PROMPT AND PROPER ATTENTION

Listed Patent Lawyer in the latest editions of the Rand-McNally Directory of Bankers and Bank-Recommended Attorneys, published by Rand-McNally & Co., Chicago, Ill.; American Lawyers Annual, Cleveland, Ohio; Bankers Service Legal Directory, published by Bankers Service Co., Boston, Mass.; and the Snow-Church Directory Co. Lawyers List, published in New York City.

WATSON E. COLEMAN, Victor Building, 724 Ninth Street, N. W.
REGISTERED PATENT LAWYER **WASHINGTON, D. C.**

INVENTORS PATENT YOUR IDEAS SEND FOR FREE BOOK



HOW TO OBTAIN A PATENT

Written by a Former Member of the Examining Corps (1922-24) of the U. S. Patent Office. If you want to profit by your idea, you should take steps to apply for a U. S. Patent at once. Your first step is to get this Free Book. This interesting illustrated book contains valuable information you should have. It tells you fully how to obtain a patent on your idea in the quickest way. With this Free Book you will also receive a "Record of Invention" form on which you can easily record your idea. Personal and Confidential Service: Your case will be personally handled only by a Registered Patent Attorney who is also a Former Member of the Examining Corps of the U. S. Patent Office. All communications confidential.

MAIL COUPON TODAY for FREE PATENT BOOK and RECORD OF INVENTION Form.

CARL MILLER

REGISTERED PATENT ATTORNEY
FORMER MEMBER EXAMINING CORPS U. S. PATENT OFFICE

Woolworth Bldg., 35th Floor, Dept. 52-A, New York City
MILLER BUILDING, Dept. 52-A, WASHINGTON, D. C.

Please send me your Free Book, "How to Obtain a Patent," and your "Record of Invention" form.

NAME

ADDRESS

BE PREPARED! SHOOT NEW BENJAMIN TARGET PISTOL



NEW Streamlined Hand Pump—Longer Shot Barrel—Larger Grip—More Power—Accurate—Practical—Economical—Safe—Clean—Quiet. No smoke or fumes. Bolt Action—Hammer Fire—Hair Trigger—Safety Lock. Single Shot BB with 1 lb. shot \$9.00; Single Shot Cal. .177 or .22 rifled—with 500 pellets \$10.50; Holster \$2.00. Also a complete line of Benjamin Genuine Compressed Air Rifles for BB and Cal. .177 or .22 pellets. Write today for complete specifications and free targets. BENJAMIN AIR RIFLE CO., 890 Marion St., St. Louis, Mo., U. S. A.

PATENTS—TRADE MARKS

All cases submitted given personal attention
Form "Evidence of Conception" with instructions for use and "Schedule of Government and Attorneys' Fees"—FREE!

LANCASTER, ALLWINE & ROMMEL
Patent Law Offices

412 Bowen Bldg. Washington, D. C.

INVENTORS! PATENTS!

Free patent advice, from one of the oldest patent firms in the U. S.—established in 1875. Reliable, confidential and immediate service. Write for FREE BOOKLETS explaining opportunities for you and patent procedure: "How We Protect You" and "How to Sell and Commercialize Your Idea" plus FREE "Certification of Invention" form.

C. A. SNOW & CO. 125 Snow Building
Washington, D. C.

INVENTORS

who derive largest profits know and heed certain simple but vital facts before applying for patents. Our book, Patent-Sense, gives those facts; sent free. Trade Marks—Copyrights. LACEY & LACEY, Est. 1869, 635 F St., N. W., Dept. 5, WASHINGTON, D. C.



FIBRE ARMS AND LEGS!

Light, correctly fitted, strong and comfortable. Natural appearance. Braces for all deformities. Scientific design. Fair Terms.

BUCHSTEIN-MEDCALF 610-3rd Av. S., Minneapolis, Minn.

ARTISTS MAKE MONEY

Find out your ability. Send name, age, occupation and address for Free Vocational Art Test.

ART INSTRUCTION, INC. (Formerly Federal Schools)
5132 Art Instruction Building, Minneapolis, Minnesota

WHOLESALE CATALOG FREE!



4000 TESTED SELLERS

For salesmen, dealers and agents. 260 pages of thrilling bargains. Over 4000 Opportunities to Make Money.

Household goods, display card items, wearing apparel, cosmetics, foods, jewelry and toys are a few of the thousands of articles shown in this exciting book for salesmen, agents and dealers. Address a postal card to address below and request a copy of this Book of Opportunity, NOW. No charge for it. Spors Co., 342 National, Le Center, Minn.

To PROTECT YOUR INVENTION—Use this coupon, NOW

Delays are dangerous and may be very costly. My personal service assures prompt action, strict confidence, and a minimum of expense. I suggest that you send me a model or drawing, or sketch and description of your invention, and \$5.00. I will make a search and report

promptly as to its patentability and send you a copy of my 72-page booklet. Or, if you prefer to read my booklet first, mail the attached coupon at once. I will also send my "Record of Invention" form. (Over 38 years experience as a Registered Patent Attorney.)

L. F. Randolph, 362-D Victor Bldg.,
Washington, D. C.

Please send me at once, free of charge, your 72 page booklet and "Record of Invention" form.

Name

Address

A PERSONAL CONFIDENTIAL PATENT SERVICE—

NEW INVENTIONS *Urgently Needed*

The need for practical new inventions to meet changed conditions of warfare and commerce is greater today than ever before. Your ideas, regardless of their nature, may fill urgent present needs. For analysis of current requirements, ask by number for the following FREE bulletins:

- No. 1—WHAT TO DO NOW, WITH MILITARY INVENTIONS.
- No. 2—TODAY'S MARKET FOR COMMERCIAL INVENTIONS.

CHARTERED INSTITUTE OF AMERICAN INVENTORS
DEPARTMENT 4, BARRISTER BUILDING WASHINGTON, D. C.

YOU'LL PROFIT BY USING THIS

VALUABLE New



ARC WELDING MANUAL

\$2.00

1942 edition explains newest techniques, methods. Contains lessons, charts, diagrams. All data any welder needs. Order now. Postpaid 5 Days FREE Inspection. Hobart Bros., Box M-521 Troy, Ohio

Hobart Welders are helping win production battle—learn to weld.

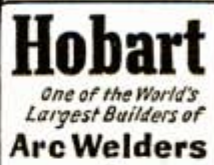

ORDER YOUR BOOKS TODAY!

Clip this Ad. Attach Your Name, Address, Money Order and MAIL.

Auto-Diesel

Master a real trade. Auto Mechanics, Diesel Mechanics, Arc Welding, Acetylene Welding, etc. Let us train you to be an expert Auto-Diesel Mechanic and help you get a good job. The cost to you is reasonable. Learn on modern equipment with tools under experienced instructors. Real shop work. Steam heated buildings. Room and board in our steam heated dormitory. We pay your fare to Nashville. For free catalog write.

Nashville Auto-Diesel School, Dept. 75 Nashville, Tenn.



INCREASE YOUR INCOME

Through Training for an Essential Job
These Books Tell You How

Are you a trained specialist—an essential worker—more important on the production line than the firing line? Know more about your trade—get better jobs and higher pay.

3 NEW INDUSTRIAL SHOP TRAINING COURSES only 95¢ each
FOR TRADESMEN OR BEGINNERS

★**ELECTRICITY** . . . complete training course in single volume, detailed with projects and assignments. Charts and illustrations simplify course. Prepared by university professors in industrial training. Valuable book for amateur or expert—only 95c.

★**METAL WORK** . . . combines four divisions of metal work: 1. Bench Metal Work—2. Sheet Metal Work—3. Ornamental Metal and Wrought Iron Work—4. Art Metal Work. Practical course for metal tradesmen or hobbyist. Special offer—all four divisions in one complete book—95c.

★**WOODWORKING** . . . Expert instruction in all phases of woodwork and cabinet making. Course made up of 71 units all bound together in one volume. Contains project assignments and test questions for each unit. Every wood worker should have this book—95c.

USE COUPON TO GET ANY OF THESE TRAINING COURSE BOOKS FOR ONLY 95c.

 Wilcox & Follett Co. Dept. P-1
 1255 So. Wabash Ave.
 Chicago, Illinois
 Please send me the Industrial Shop Training Courses marked below for your special price of 95c each.
 City..... ELECTRICITY
 Name..... METAL WORK
 Address.....State..... WOODWORKING
 On delivery I will pay postman Enclosed is cash or money or 95c for each course ordered (plus def. Send courses postage pre-paid, few cents C.O.D.)

Say you saw it in Popular Mechanics!

New York Electrical School Established 1902
Ask for free illustrated booklet
44 West 17th St., N. Y. C.

LEARN MONEY-MAKING CARTOONING
Some Simplified Method that has helped train creators of "Terry & Pirates," "Wash Tubbs," "Out Our Way," "Winnie Winkle," "Reg'lar Fellers," "Stranga As It Seems," "Secret Agent X-9," and many others. Earn while learning. Rush 10c for Picture Chart (to test your ability), and full details. (State age.)
THE LONDON SCHOOL, 425 National Bldg., Cleveland, Ohio

STUDY ENGINEERING AT HOME
With A Chartered Educational Institution

Courses in ENGINEERING: Electrical, Civil, Mechanical, Drafting, Architectural, Steam, Aeronautical, Radio, Structural, Mining, Industrial, Highway, Petroleum, Marine, Chemical, Arts; Sciences; Philosophy; Education; Public Health; Medical Jurisprudence; Psychology; Sociology; Physics; Chemistry; Geology; Pol. Science; Theology; Law; Agriculture; Business Training; Accounting; Mathematics; Statistics.

McKinley-Roosevelt Incorporated, 4610-TD, Sheridan Road, Chicago

★ WANT A GOVERNMENT JOB ? ★

Prepare immediately for 1942 Examinations

\$1260 TO \$2100 FIRST YEAR

Railway Postal Clerks—Postal Clerks—
Mail Carriers—Border Patrolmen—Ste-
nographers—Typists, etc. War greatly
increasing many appointments.

FRANKLIN INST., Dept. J174, Rochester, N. Y.

Gentlemen: Rush to me, without charge, 32 page book with list of U. S. Government big paid positions. Advise me also regarding salaries, hours, work, vacation, etc. Tell me how to qualify for a position.

32 Page Civil Service Book—FREE

 Name.....
 Address.....



CLASSIFIED Advertisements



Advertisements in this section, 35 cents per word, each insertion, minimum 10 words, payable in advance
To be inserted under proper classification in June issue, copy should be in our office April 8th
June issue on sale May 1st

Popular Mechanics Magazine, 200 East Ontario Street, Chicago, Illinois

YOU'LL PROFIT

By reading and answering the classified ads in this section. Hundreds of opportunities to make and save money.

Popular Mechanics Magazine, 200 E. Ontario St., Chicago, Ill.

Dear Sirs: I am advertising in your Classified Department, and am writing to let you know that I am well pleased with the results obtained. I have received letters in answer to my ad from every state in the United States, from every province in Canada, from Mexico, from Chile, South America, and from the Hawaiian Islands. Every month has been the same, new names have come into my mailing list, and these are real live buyers who have put my business way out in front, at a time when plenty of others are having tough going. I feel that your classified ads are the very best medium I can use to put my Angora rabbits before the public.

(Original letter on file in our office)

DAKOTA RABBITRY.

AUTOMOBILES—MIDGET CARS

AUTOMOBILE Racing book, fifth edition, well illustrated. Instructions on building bodies, frames, engines. Ford A and B conversions. Plans, AAA rules, specifications. Roadster racing. Indianapolis cars. \$1.00 postpaid, \$1.15 C.O.D. Ray Kuns, Dept. 41, Madisonville, Cincinnati, Ohio.

CONQUER Priority fear! New rims, rebore needless! Details, Devereaux, Box 212-J, Battle Creek, Michigan.

PROFESSIONAL Midget racers, two-passenger roadsters. Midget motorcycles, motorscooters. Parts, plans, wheels. Handbook catalog—125 illustrations, plans—20c. Midwest, Box 1959-C, Chicago.

WHIRLGAS Superchargers, \$3. increase mileage 20%; power 10%. Refund guarantee. University test. Any car; give make, year. Wrench installs 15 minutes. John Hanley, Manufacturer, 5719 Loraine, Detroit, Mich.

FREE—Big list of helpful books. Popular Mechanics Press, 200 E. Ontario St., Chicago.

AUTO SUPPLIES AND EQUIPMENT

PLATES—The latest in plastics, unique. Send \$1.00 for 2 "Keep 'Em Flying" imprinted with the attractive aviation star, two colors, 4 inches diameter, weather proof; guaranteed to please. Special plates for clubs, organizations, Red Cross, etc. U. S. Insignia Company, 509 Fifth Avenue, New York, N. Y.

LUMINOUS Lacquer—Dries fast to any surface, glows at night. Ideal for blackouts. Small bottle 35c. 1591 Highland, Detroit, Michigan.

1942 **IGNITION** Supercharger \$1.75. E. G. Sales & Mfg. Co., New York.

WINDSHIELD—Scratches easily polished clear. Car-owners kit—Tools, materials, copyrighted instructions, 50c postpaid. Garage sized kit \$1.00. Pfeeger Optical Company, 250M, Sunbury, Penna.

NEW Spark plugs 30c. 811 East 31, Kansas City, Mo.

RECLEAN Used oil without cost. Oil never deteriorates, merely gets dirty. Write, Gerwin, Alva, Oklahoma.

ACTANE Fuel Compound increases mileage, removes carbon. 35c brings liberal trial bottle prepaid. Stanley Huslin, 3500 Aldine, Philadelphia, Penna.

MINERAL Mined here in Rocky Mountains rebore and rings. Sample free. Manufacturers wanted, Xralite, 12 Pine Street, Kallispell, Montana.

PLATING Outfits for auto parts. Connect to a battery. No tanks used. Free particulars and proofs. Gunmetal Co., Ave. J, Decatur, Ill.

AUTO TRAILERS

ALL About trailers, construction, parts, supplies, etc. 64 pages vital information for anyone interested in home trailers. Send 25c. Stephes Co., 2801PM 14th, Kansas City, Mo.

READY Now—Plans for nine new Jim Dandy Trailers including six modern house trailers. Catalog 10c. Also new edition of Trailer Builders Manual and catalog of parts, supplies and equipment. Price 25c. Both 35c postpaid. Trailer Supply Co., 5120-A Fulton St., Wausau, Wis.

MOTORCYCLES, BICYCLES, MOTOR-SCOOTERS AND SUPPLIES

MOTORCYCLISTS. We can save you money on parts and accessories. Bargain list and decal free. Illustrated Henderson list 10c. Triangle, 2157 Harrison, Chicago.

MOTORCYCLE Bags—\$3.90 pair and up. Allen Streamlined Bag Co., 216 Summit St., Elgin, Ill.

BUILD Electric power bicycle, low cost, easily built, operate cheaply, practical. Detailed plans 50 cents. Leand Hoke, 312 Market Street, Watertown, Wisconsin.

BUILD 6 Inch dia. friction clutch for shop, scooters, inboards, power mowers. Plans, castings, parts. Send stamped envelope. Build Craft Engineering Co., Linden, New Jersey.

MOTORCYCLES, Reconditioned. New, used, parts and accessories. All makes. Large stock. Bargains. Illustrated catalog, 15c. Indian Motorcycle Sales, Kansas City, Mo.

PISTONS And parts, new and used, all models. Catalogue and wings pin 10c. Ballak, 811 N. 9th, St. Louis, Mo.

AVIATION

3 "AVIATION Star" buttons for the lapel, attractive colors; send 25c in coin. Plastic Art Company, 6 Sickles Ave., New Rochelle, N. Y.

AVIATION Cadet examination preparation by home study course. Rutherford Preparatory School, Long Beach, Calif.

BUILD And fly your own motorcycle powered monoplane, home. Easy, cheap. Tested plans, guaranteed, \$1.00. Aerotech, Dearborn, Mich.

AVIATION Cadet examination preparation by home study course. Rutherford Preparatory School, Long Beach, Calif.

PROPELLERS—Special siled 3 blade, all types, sizes, lists free. Ford aircooled conversion diagrams, 25c. Lightplane literature, supplies. Standard Aircraft, Ft. Worth, Texas.

BATTERIES, GENERATORS, ETC.

EDISON Lifetime storage batteries for light and power. Eliminate acid battery diseases. Long guarantee. All kinds rebuilt generating plants, motors, and miscellaneous articles at bargain prices. Free interesting literature. T. Hawley Smith Co., Croton Falls, N. Y.

ELECTRIC Light plants, 5000 watt, DC Diesel, AC gasoline. Burns Automobile, Dayton, Ohio.

BUILD Electric plant operated by wind from automobile generator. Complete plans and 1942 catalog 10c. LeJay Manufacturing, 447 LeJay Building, Minneapolis, Minn.

GENUINE Edison batteries for light, power. Non-acid. Fifteen year life. Five year unconditionally guaranteed. Low prices. Complete lighting plants. Free literature. See-Jay Company, 82 Sterling Avenue, Yonkers, New York.

ELECTRIC FENCING

NEW Type fence electrifier made from automobile coil. Complete plans and 1942 catalog 10c. LeJay Manufacturing, 447 LeJay Building, Minneapolis, Minn.

ELECTRICAL SUPPLIES—EQUIPMENT

$\frac{1}{2}$ HORSE, 3450 Speed, repulsion induction alternating motors \$11.75; 500 watt alternating generators \$26.50; other sizes. Butler Electric, 1885 Milwaukee, Chicago.

FREE! 1942 Catalog—1000 electrical bargains. LeJay Manufacturing, 847 LeJay Building, Minneapolis, Minn.

COIL Winding, solenoids, electro-magnets, transformer supplies, re-building service. Free circular. Thomas Company, 321 Caroline St., Neenah, Wisconsin.

ELECTRIC Pencil: Writes-engraves all metals. \$1.00 postpaid. Beyer Mfg., 4515-H Cottage Grove, Chicago.

WE Buy, sell and trade electrical wiring material, lighting fixtures, equipment and tools. J. R. Estes Co., 4001 Winchester, Louisville, Kentucky.

WELDING—SOLDERING—PLATING

ARC Welders wanted by the thousands. Learn with 516 page lessons manual. Over 500 how-to-do-it photos. \$2.00 copy. Money-back guarantee. Hobartweld, Box M-524, Troy, Ohio.

GOVERNORS—Auto engine speed control. Candee, 129-W Llewellyn, Los Angeles.

WELDING Outfits, for heavy, medium, light metal welding \$37.33 up. Welding supplies, accessories, a.c. electric welders. Write today. Superior Oxy-Acetylene Co., Hamilton, Ohio.

BUILD D.C. arc-welder, without re-winding armature; light plant generators; D.C. motors; automobile generators. Plans \$1.00 each. Welders Club, AB-3432 M-Mart, Chicago.

SAVE 50% On a.c. welders. Plans. Holger's Service, Canton, Kans.

MACHINERY, TOOLS AND SUPPLIES

BUILD Your own machine tools. Lewis furnishes semi-finished castings for bench milling machine and shaper; rough castings for 23 metal and woodworking tools. Shop-tested materials and professional blueprints. Never a complaint on quality, design or price! Send 10c—New 1942, 32 page illustrated catalog. Lewis Machine Tool Co., Dept. M-17, Box 116, Station A, Los Angeles.

DEALERS! Lowest prices. Stoker, blowers, oil burners. Automatic gas, coal, oil furnaces, stoves, water heaters. Plumbing supplies. Fans, coolers, coils. Biggs Supply, Lincoln, Nebraska.

BUILD Your own lathe grinder, castings, building instruction \$2.50. Particulars 10c. Star Machine Shop, Kingfisher, Oklahoma.

CONCRETE Building block machines and molds. Easy payments. Catalog free. Concrete Machine Co., 5129 South Compton Ave., St. Louis, Mo.

13"x5" WILLARD Lathe with gap. No. 2 Pratt & Whitney hand milling machine, four step cone drive. Write for full particulars. Cincinnati Machinery & Supply Company, 217 E. Second St., Cincinnati, Ohio.

GRIND Drills like factory: attachment for bench grinder. Cheap. Factory, 811-B East 31, Kansas City, Mo.

HARD-TO-GET Hardware for defense; over 1,000 piece assortment. Screws, nuts, bolts, washers, rivets, brackets, etc. All plated—first quality. Satisfaction guaranteed. 5 pounds special \$1.98. Limited supply. Manufacturers Products, 212 West Hubbard, Chicago.

BENCH Machine tools—15" planers \$125. 6" feed 4 1/2" vertical production mills \$125. 5" shaper \$125. Each within .002 mach. vice \$19.50. Index centers \$19.50. Ender Co., Santa Ana, Calif.

MACHINISTS Tool chests at bargain prices. Circular free. Cepuder, 3602 Wesley, Berwyn, Ill.

ENGINES, MOTORS, DYNAMOS

SUPERHEATED Steam engine, self starting, size—about 2" bore, 2.5" stroke, length 15.5", weight 35 pounds, variable expansion gear. Trippe, West Point Pleasant, New Jersey.

BIG Pay jobs in welding. Complete welding lessons and reference book. 516 pages. 41 lessons. \$2.00 copy. Money-back guarantee. Hobartweld, Box 525-M, Troy, Ohio.

ELECTRIC Motors—1/2 to 30 hp. Guaranteed used bargains. Give size wanted for price. Baums Metal Specialties, Kansas City, Mo.

1/2 H.P. Capacitor motors, 3600 r.p.m., \$9.75. Other alternating and direct current bargains. CMCO, 514 Van Buren, Chicago.

GOVERNORS—Auto engine speed control. Candee, 129-X Llewellyn, Los Angeles.

SMALL High speed universal motors, 1/10 h.p. Supply limited, \$2.50 postpaid. McConnell, 701 Wolff, Racine, Wis.

WINDING Data, 225 motors, single and three phase, \$1.00. Motor Data Co., Box 7631, Kansas City, Mo.

AC and DC generators, motors, exhaust fans. State your needs. Queen City Electric, 519 South California, Chicago.

BOATS, OUTBOARD MOTORS, ETC.

REBUILT Outboard motors. Fully guaranteed. Over 300 to pick from. Send 10c for complete list. Boat design book 15c. Buy now before prices advance. Chicago's largest dealer. Masters & Son, 214 West Chicago Ave., Chicago.

MARINE Conversion parts for all auto engines. Buy here and save. Conversion Parts Co., 278 Adams St., Boston, Mass.

CONVERSION Information, automobile transmissions, manifolds, etc. Plans \$1. Engine problems solved (fee). Conversion Service, 72nd Drive, Flushing, N. Y.

KAYAKS Outboards, rowboats, duck-boats, construction kits. 10c for catalogs. Cre-Craft Boats, Millburn, New Jersey.

TEN Plywood boat plans 50c. Free catalog boat building plans. The Rudder, 15 Murray Street, New York.

NEW Type electric outboard motor made from auto generator. Uses car battery. Complete plans 10c. LeJay Manufacturing, 547 LeJay Building, Minneapolis, Minn.

PULL Size cut to shape patterns, blueprints, \$3.75 up. Pleasure boats, to 38 feet. Knock-down frames. Illustrated "Build a Boat" catalog, 10c. "How to Build Boats" book, \$1.00. Cleveland Boat Blueprint Co., Station A-66, Cleveland, Ohio.

BOAT Designers are highly paid professionals. Complete course by mail. Catalog. Westlawn, Montville, N. J.

OUTBOARDS—Save 1/2. Good used parts, all makes and models. Bargains rebuilt motors. Crandall Hicks Co., 959 Commonwealth, Boston, Mass.

14-FOOT Outboard runabout. Build it yourself. Easy-to-follow instructions 25c. Popular Mechanics Press, 200 East Ontario, Chicago.

BUILD Your own boat with knock-down frames. Easy to put together. Save 2/3 builder's cost. Big boat catalog—25c. Brooks Boat Co., Dept., FP, Saginaw, Mich.

FORD—Mercury—Zephyr marine conversions. Catalog 10c. Lehman Engineering Company, Dept. D, Newark, N. J.

OUTBOARD Motors, bought, sold, used parts. Outboard Exchange, 9614 Flatlands Ave., Brooklyn, N. Y.

SPORTING GOODS, GUNS, FISHING TACKLE, ARCHERY, TRAPPING

FREE Book—"Helpful Fishing Hints." Just out; compiled by the makers of the famous, prize-winning Richardson Rods. You need this practical book no matter what waters you fish or what kind of fish you like to catch. One fisherman calls it "the most helpful aid to anglers since Izaak Walton." Send for your copy; it doesn't cost you a cent. Just drop us a line; "Send me free book, Helpful Fishing Hints." Address Richardson Rod & Reel Company, 3178 N. Sawyer Ave., Chicago, Illinois.

ROME Tackle for finest archery equipment. Catalogue 3c. Box 166, Rome, N. Y.

BARGAINS! Gun catalog 5c. Camera catalog 10c. Fishing and archery catalog 5c. Golf-tennis catalog 10c. Warshaw's, First-Madison-PM, Seattle.

BOWS, Arrows, accessories, materials. Write for 1942 catalog. Hatfield's, 1762-A N. Vermont, Hollywood, Calif.

USED Guns, bought, sold, exchanged. List stamp. Howe Fur Company, Coopers Mills, Maine.

ARCHERY Equipment: Catalogue free. Mid-West Archery, 2209-A East 75th, Chicago.

WANTED—Guns, equipment. Buy, sell, trade. Gordon Joslyn, Greenfield, Mass.

"RAISE Earthworms for Profit." Information free. Stamp appreciated. Bureau Zoological Research, 105 "P" Broadway, Peoria, Ill.

ATHLETIC EQUIPMENT—BODY BUILDING COURSES

ACROBATICS—Flips, air somersaults, handstands, handbalancing. Circus method instruction, \$2.00. Wallace Power, 923 W. Vine, Kalamazoo, Michigan.

BAR-BELLS, Exercise equipment. Courses. Special offers! Free booklet. Good Barbell Co., 4676aPM, So. Grand, St. Louis, Mo.

BE Strong, muscular, full of pep. Amazing new body-building course. Write Olympic System, Dept. M, Waterville, Maine.

ANTIQUES, RELICS, INDIAN GOODS, CURIOS

FIVE Different Indian tools 50c. Catalog 5c. The Sistershop, Northbranch, Kansas.

10 TINY Beautiful perfect bird arrows \$1.00. List free. Lear Howell, Glenwood, Arkansas.

GLASS, Books, minerals, curios, catalog 5c. Junes Antiques, Northbranch, Kansas.

ANTIQUE Firearms, swords, daggers, powderhorns, Indian curios. Lists free. Nagy's, 8 South 18th, Philadelphia, Penna.

INDIAN Relics, coins, bills, gems, crystals, curios, etc. Illustrated catalog 5c. 100 ancient arrowheads \$3.00. H. Daniel, Hot Springs, Ark.

25 GENUINE Indian arrowheads, \$1.00. Catalog. Geo. Holder, Glenwood, Ark.

SWORDS, Pistols, daggers, armor list 10c. Robert Abels, 860A Lexington Ave., New York.

INDIAN Relics, beadwork, coins, curios, minerals, old glass. Catalog 6c. Indian Museum, Osborne, Kansas.

FIELD GLASSES, TELESCOPES AND MICROSCOPES

TELESCOPES, Microscopes, binoculars; bargain catalog free. Brownscope Company, 125 West 45th Street, New York.

REFLECTING Telescopes, 3 1/2" diameter, equatorially mounted. View planets, stars, \$16.50. Write Skyscope Co., 475 - 5th Avenue, New York.

LENSES—Build your own telescope, field glass, microscope, riflescope, etc. Assortment of fifteen lenses—\$1.00 postpaid. Slightly chipped on edge. Satisfaction absolutely guaranteed. American Lens Company, 324 North Mayfield, Chicago.

DOGS, PETS, BIRDS, RABBITS

ANIMALS, Birds, reptiles. All kinds. Send stamp for lists. Snake King, Brownsville, Texas.

MONEY Raising rabbits. "Investigate." Folder 10c. Close Rabbitry, Tiffin, Ohio.

ST. BERNARDS—All breeds—Details free! Book 108 colored pictures, descriptions recognized breeds, 35c. Royal Kennels, No. 91, Chazy, N. Y.

TREES, SHRUBS, ROOTS, HERBS

IMPROVED Nut trees—for backyard hobby. Many kinds. Information free. Michigan Nut Nursery, Union City, Mich.

EVERGREEN Tree seedlings for spring planting. Certified. Hardy, Good quality. Order early. Suncrest Evergreen Nurseries, Johnstown, Penna.

FARMS—FARM LANDS—REAL ESTATE

47 ACRES, Furnished home—\$1200—On highway, handy village, few steps to river; part tillable; 7 rooms, 2 fireplaces, electricity, beautiful bay view; non-resident owner sacrifices; page 50 new catalog 1384 bargains many states mailed free. Strout Realty, 235-P 4th Ave., New York City.

GOOD Farm bargains. Washington, Minnesota, Montana, Idaho, Oregon, North Dakota. Dependable crops, favorable climate. Write for literature and lists describing typical farms for sale. Specify state. J. W. Haw, 119 Northern Pacific Ry., St. Paul, Minn.

GOVERNMENT Land \$1.00 acre up. Information all states 25 cents. National Tax Service, 1037A Majestic Bldg., Detroit.

40 ACRES, Near White River, unimproved; poultry land, \$190. \$5 down, \$5 monthly. Free list and literature. Hubbard, 216 Grossman Bldg., Kansas City, Kans.

SEE The Highlands of Louisiana. Choice cut-over land selling at low prices on liberal terms. Descriptive book sent upon request. Long-Bell Farm Land Corp., 878 R. A. Long Bldg., Kansas City, Mo.

FARM MACHINERY AND SUPPLIES

MANY Have built at small cost, their own garden tractor powered by engine from washing machine or lawn mower, etc., and handy farm tractor powered by old automobile engine. \$1.00 brings our plans postpaid for building either: state which is wanted, plans for garden tractor or farm tractor. Shaw Mfg. Co., Galesburg, Kansas.

POULTRY AND FARM SUPPLIES

PROMPT Shipment on Salem Champion chicks. Prices low, 18 varieties. Sexed or unsexed. Catalog free. Salem Hatchery, Box 81, Salem, Indiana.

DAVIS Chicks, amazingly low prices this year. 21 varieties. Catalog free. Davis Poultry Farm, Route 34, Ramsey, Indiana.

LOW Factory prices on poultry equipment. Wire fabrics. Free 100-page catalog. Bussey Pen Products, 5149 West 65th Street, Chicago.

MORE Profits from poultry—Learn how others get big daily income. Read America's leading poultry magazine. Three years 50c, six months 10c. Poultry Tribune, Department PB-1, Mount Morris, Ill.

RAISE Turkeys the new way. Make \$1500.00 to \$3000.00 per year in your own back yard. Write for free information telling how. Address National Turkey Institute, Dept. 1, Columbus, Kansas.

PROFITABLE OCCUPATIONS

WELDING Pays. Learn with 1942 trade school text manual. 516 pages. Over 500 photos. \$2.00 copy. Money-back guarantee. Hobartweld, Box M-523, Troy, Ohio.

\$40.00 WEEKLY. Made growing mushrooms, fresh, dried. Dominion patent 331583. Free spawn. North American, 169Y Yonge, Toronto, Canada.

STANDARD Rabbit Journal, Milton, Pa. 3 years \$1.00. Sample dime.

MECHANICALLY Inclined men—Own and operate general appliance repair shop. Complete, illustrated course shows you how. Welding, refrigeration, motor repair, how to get business, etc., all phases covered. Free literature. Christy Supply, Dept. 416, 2835 N. Central Ave., Chicago.

PROFITS From crankcase drainings. Save plenty! Particulars. Bx 102, Austin, Texas.

RAISE Chinchilla rabbits for us. We pay up to six dollars each. Catalog and contract 10c. Book catalog. Year subscription Rabbit Magazine 25c. Stahl's, Box 10, Holmes Park, Mo.

WILL You give us 5% first \$600 you make? Afternoons free! Work home. \$1,000 month reported (exceptional—full-time). Expect surprise! National. Box 1246, San Bernardino, Calif.

ANNOUNCING New home study course in commercial baking. Good field. Nearly depression proof. Common school education sufficient. Send for free booklet "Opportunities in the Baking Industry" and requirements. National Baking Institute, 1315 Michigan, Dept. 3433, Chicago.

RAISE Angora rabbits—wool brings \$5.00 pound. Particulars free. Grinstead's, Edwardsville, Illinois.

YOU'LL Like resilvering mirrors, tableware, making chipped glass nameplates, signs, outfit prices. Sprinkle, Piater, 288, Marion, Indiana.

ANGORA Wool rabbits pay. America's fastest growing industry. Start now. Dakota Rabbitry, Oakes, North Dakota.

MONEYMAKING Ideas—Latest books—Bargain catalog free. Popular Mechanics, 633 St. Clair, Chicago.

BOOKS, PERIODICALS, PICTURES, POSTCARDS

REBINDING: We rebind books, Bibles, and hymnals. Attractive and reasonable. Also, magazine binding. Heckman Bindery, Dept. D, North Manchester, Indiana.

SAVE Money, time, material—763 methods. Amazing new book. Details free. Alsip, Highland Park, Illinois.

PHOTOGRAPHS. Samples, list, 25 cents. Hunter's, 215 Church Street, Ferguson, Missouri.

EXCELLENT Sparetime profits taking subscriptions—2500 magazines. Complete starting supplies free! Pines, 583 Monroe, Brooklyn, N. Y.

PUBLICITY! "Profitable Publicity," highly endorsed book, tells how to get it! \$2.50 prepaid, from Dorset House, Publishers, 49 West 42nd Street, New York.

GENUINE Oil paintings 8x12". \$1.00; 10x20", \$2.00. Dissell, 4667 Rockwood Road, Cleveland, Ohio.

ARTISTIC Photographs. List, sample, dime. Parisette, 88 Nunn Building, Rochester, N. Y.

ART Pretty girl pictures. Nifty new series. Complete set 18 pictures \$1.00. Sample package 25c. Each picture full postcard size 5 1/4 x 3 1/4. Harlen, Box 10, Station J, New York. Dept. A19-B.

ART Studies—Magazines, courses, books. Catalog 10c. Ciccone's, 863(F) First Avenue, New York City.

DARING Exposure of legal and illegal "rackets" that made fortunes for the operators. Valuable to consumers. Twenty complete chapters, postpaid \$1.00. Alraco, 2321 Allen, Allentown, Penna.

AMATEUR Astronomers—8 x 10 enlargement of the moon—50c. J. Loefte, 1530 N. 29, Milwaukee, Wis.

CURRENT Copies business, vocational, diversion magazines. Choice 400 different publications. Free price list. Commercial Engraving Publishing Company, 34C North Ritter, Indianapolis, Indiana.

MACHINIST'S Reference book \$1.00 postpaid. G. A. Knudsen, 523 - 48th St., Brooklyn, N. Y.

BACK Number magazines. List 3c. Ewen's, 118-01 200 Street, St. Albans, N. Y.

ANY Book (new, used, out-of-print, rare) promptly supplied! Lowest prices! Send for free bargain catalogues! Old Prof's Book Shop, M16 Arcadia Court, Pontiac, Mich.

BACK Number magazines, also book bargains, list 10c. Magazine Mart, Roslyn, N. Y.

TRAVEL By mail: beautiful scenic photos, Texas, Mississippi, Louisiana. Four sets \$1.00. Tourist Pictures, Kilgore, Tex.

ARTISTIC Girl pictures. Real models. 8 postcards 25c. 20—50c. 50—\$1.00. Scott's, Box 342, Covington, Ky.

LATEST "Woodford's Trial and Error" \$1.50, formerly \$3. Arthur Lifshin, 208 Washington Ave., Chelsea, Mass.

HOUSE Plan books—Latest titles—Bargain catalog free. Popular Mechanics, 633 St. Clair, Chicago.

GAMES—ENTERTAINMENT

YOU Can entertain for all occasions with Trick Chalk Stunts. Laugh producing program, \$1.00. Catalog 10c. Balda The Cartoonist, Oshkosh, Wis.

PLAYS, Operettas, musical comedies, complete minstrel first-parts with song programs, blackface skits, vaudeville acts, monologs, dialogues, recitations, juvenile plays and songs, musical readings, entertainments, make-up goods. Catalog free. T. S. Denison & Co., 203 N. Wabash, Dept. 11, Chicago.

MAGIC TRICKS, PUZZLES, JOKER NOVELTIES

DOUGLAS' Famous 1942 catalog of 500 tricks just out! Tricks you can do! Brand new effects for pocket, parlor, stage. With coins, cards, cigarettes, ropes, balls, thimbles, apparatus. Magic books, illusions. Send only 10c for year's biggest catalog value. Douglas Magic Shop, Box 274, Dallas, Texas.

CLOUDS Of smoke from finger tips, empty hand effect, mystifying. See magic dealer or for 35 performance tube send 50c; three, one dollar. Regan Laboratories, Calton, N. J.

VENTRILOQUISM. Secrets revealed. Home study course. Free particulars. State age. Fred Maher School of Ventriloquism, 1703 Casgrain Avenue, Detroit, Michigan.

NEW! Simplified card tricks! Self-working miracles! 25c (coin). Particulars free. Conaway, H-123, Champaign, Ill.

POCKET Magic. Deluxe catalogue twenty-five cents. Magicraft, Harrisburg Station, Houston, Texas.

MAGICAL Books, catalog free. Hosley, 8 Seminary Street, Auburn, New York.

NEW Vanishing key and catalog 25c. Sterling Magic, 345 John R, Detroit, Mich.

PROFESSIONAL Magic for amateurs! Pocket tricks! Joker's novelties! Hundreds of items! Complete line! Two big catalogs combined into one giant edition! 600 illustrations! Only 10c. Vick Lawston, Dept. J23, Queens Village, N. Y.

TORN And restored napkin. World's finest. Complete \$1.00. Paragon, 333 N. Michigan, Chicago.

MAGIC Age cards. Tells anyone's age. 3c stamp. Lawrence W. Kiley, Birmingham, Michigan.

BE A magician. Large professional magic catalogue of latest tricks 25c. Ireland, C-109 North Dearborn, Chicago.

HOLLYWOOD Special! Magicians button, catalogue, ghost illusion and free trick for 25c. Magic House of Charles, Box 888, Hollywood, California.

EARN Money in any crowd. Call names of strangers, tell unspoken questions. Professional course mind reading, spirit writing, etc., \$1. Henderson, Box 341, San Bernardino, Calif.

WORLD'S Largest professional magic shop keeps you in touch with latest tricks. To receive mailings send 25c for 1942 catalog. Holden, 220 W. 42nd St., New York.

MAGICIANS' Headquarters. 216-page catalog, pocket, parlor, professional tricks. 25c. Kanter's, M-1311 Walnut, Philadelphia.

OLD STAMPS WANTED

I WILL Pay \$100.00 each for 1924 1c green Franklin stamps, rotary perforated eleven (up to \$1,000.00 each unused). Send 6c today for large illustrated folder showing amazing prices paid. Vernon Baker, (23-PM), Elyria, Ohio.

STAMP COLLECTING

WORLD'S Smallest airmail—diamond and triangle stamps, free stamp magazine, also magnifier to study your stamps, with large collections of stamps from scarce countries. A bargain. 5c with approvals. Capital Stamps, Dept. 2, Little Rock, Arkansas.

SENSATIONAL Combination offer! Big packet 105 different including Iceland, Manchukuo, Ecuador (American flag in full colors), Danzig, airmails, commemoratives, triangle stamps. \$4 United States; complete set United States telegrams, cataloging 20c. Packet British Colonies, including Gwallior, Hyderabad, Burma (new country) jubilee and coronations. Scarce Far Eastern republic cataloging 50c. Big illustrated lists of other bargains. Total catalog price over \$3.00! All for only 5c to approval applicants! World-Wide Stamp Company, Department 600-N, Camden, New York.

CONFEDERATE Stamps catalog \$325.00. But 25c buys exact facsimiles (will baffle experts). Send no money; your request brings them for free examination. George Wentz, Dept. P, San Marcos, Texas.

40,000 VARIETIES Foreign approvals 1/4c up. First class service, honest prices, fair treatment. Representative selection on request. PKEigwin Stamp Company, Vineland, N. J.

\$2.50 CATALOGUE Fine mint United States commemoratives \$1.00. Keystone Stamp Exchange, Drexel Hill, Penna.

VICTORY Packet free—Includes stamps from Tanganyika, Borneo, animal, scarce babyhead, coronation, early Victorian, airmail, map stamps, with big catalogue—all free—send 5c for postage. Gray Stamp Company, Dept. PM, Toronto, Canada.

SEYCHELLES, Neld, Caymans, Manchukuo, Brunel, Turks Caicos, British Somers (Cannibaland). Everything 3c with approvals. Viking, 130-Z Clinton St., Brooklyn, N. Y.

POSITIVELY Greatest offer—100 different U. S. old and recent issues 50c; 50 different U. S. 25c; army and navy 12c; bicentennial 10c; Ohio canalization 5c—Absolutely free to approval applicants—Sesquicentennial Exposition issue of 1926. American Stamp Exchange, 3420 Montclair, Detroit, Michigan.

(PORTUGUESE Empire) or (Spanish-Italian) 190—220 variety mixtures, plenty commemoratives, \$1.00. Plank, 3164 - 34th Street, Astoria, New York.

AGENTS Wanted to sell stamps, no investment. William Waugh, 2140 N N. W., Washington, D. C.

500 U. S. mixture, including high values and commemoratives, 15c. Davis, Box 162, Newburgh, N. Y.

FREE Mint set Austria semi-postals to applicants for selected foreign approvals in sets. Herold, Box 1167, Woodhaven, N. Y.

MINT Clark, with United States catalog 5c. Approvals, Gobrecht, 205 Anderson, Joliet, Ill.

FREE Big packet, Brazil, etc. Approvals. Philip Stafford, Wurtland, Ky.

ESTHONIA 25 Different 10c. Approvals. Hermes Stamp Company, Box 276, Hempstead, N. Y.

UNUSED Foreign sets at bargain prices. On approval against reference. Paul Rogers, Tuscarawas, Ohio.

200 DIFFERENT South and Central American for \$1.10. William Leedom, Mt. Carmel Avenue, Glenside, Penna.

4000 WORLDWIDE \$1; approvals on request; 200 different \$1. Griest, 409 Oak, Davenport, Iowa.

\$10 UNITED States stamp; packet dollar values; illustrated brochure Canada stamps 3c. Peterson, Box 31, St. Paul, Minnesota.

NEW Wholesale catalogue. Fifty-eight page list free to dealers. Empire Stamp, Dept. 5, Toronto, Canada.

ASTONISHING! 100 Different 5c! Attractive approvals. United Stamp Service, Box 491-K, Lexington, Kentucky.

500 FINE Mixed U. S. stamps with historical cover of Civil War period, only 25c. Wright, 201 Mealy, Hagerstown, Md.

U. S. 1873-1942 Mixture, off paper. Over 500 stamps 30c. Morrell & Co., 203 Fenimore St., Brooklyn, N. Y.

TEN Cent packets; 15 airmails, 50 British colonials. Free illustrated lists. Creevey's, Berwick, Penna.

50 FREE Kwangchowan, etc. Album 3c. Bullard 13 Winter Hill, Mass.

PHILIPPINES—Eight different, 10c coin, with approvals. Read, 3401 Parnell, Chicago.

CORONATIONS, Ten different 5c with junior approvals. Lange, East Freetown, Mass.

FREE! Bavarian railroad, 14 varieties. Rev Benter Burke, S. Dak.

U. S. Parks perforated complete used set 25c, approvals included. Bedrin, 2005 Walton, New York, N. Y.

KNOW Your stamps! Read "Postage" monthly, 25c year. Alhambra, Calif.

AIRMAILS. Special selections on approval. Ireman, Box 204M, Blue Island, Ill.

UNPICKED! 100 U. S. revenues on documents—10c! (700—50c.) "Vanvoorhis, Hyndman, Penna."

LOWEST United States stamp prices. Free illustrated catalogue. Creevey's, Berwick, Penna.

CURRENT Copies stamp, business, vocational, diversion magazines. Choice 400 different publications. Free price list. Commercial Engraving Publishing Company, 34C North Ritter, Indianapolis, Indiana.

NICARAGUA Will Rogers set, 7c. A. Gustafson, Box 1206, New Britain, Conn.

SCARCE! "Hard to get" packet including Afghanistan, Alauotes, Burma, many others 5c to approval applicants. Midwest Stamps, New Hampton, Iowa.

NEW Ways to exchange duplicates! Become a participant of our Exchange Circle and you can select leisurely at home without money from stamps sent to you by fellow participants. No dues. Write now for free information XIV! Liberty Stamp Exchange Circle, 30 East 92nd St., New York.

50 DIFFERENT Persia 25c with approvals. Pinehurst Stamp Co., 90 Pinehurst Ave., New York.

LOOK! 1000 Different only \$1.50; 2000, \$4; 3000, \$8. Fred Onken, 630 79th St., Brooklyn.

9 ALL Different Piume 5c to approval applicants. Wonder Lake Stamp Co., Rout. No. 1, Ringwood, Ill.

POSITIVELY Greatest free offer—Latest Scott's International \$4.00 stamp album—covering entire world, contains 36,000 illustrated, descriptive spaces; Scott's 1942 standard \$3.50 catalogue "Philately's Encyclopedia"—absolutely free to applicants for foreign approvals becoming customers. Bargain Stamp Service, Indio, California.

SPECIAL, General collection \$10.00 catalog value, \$2.00 postpaid. M. A. Hayes, Conewango Ave., Ext. R. I., Warren, Pa.

133 PICTORIALS, Commemoratives, etc., including sets, 10c. MacDonald, Vineyard Haven, Mass.

U. S. Commemoratives—80 different, 25c. Crystal Stamp Co., Racine, Wis.

MIXTURES—Gigantic catalog for 5c postage. Exchange your stamps with members the world over, complete details 5c. Stamp Collectors' Exchange Club, Station D, Toronto, Canada.

WORLD'S Smallest airmail—diamond and triangle stamps, free stamp magazine, also magnifier to study your stamps, with large collections of stamps from scarce countries. A bargain, 5c with approvals. Capital Stamps, Dept. 2, Little Rock, Arkansas.

WIN Free stamps—Fascinating contest—Every approval applicant wins—No obligations—Try your ability. Mutual Stamp Service, Fellows, California.

SMOKY Mountain sheet with 10 beautiful commemoratives. Approvals 5c. Stamp Shop, 809 Holland Bldg., St. Louis, Mo.

FREE—Two good sets, one mint. Approvals. Postage 3c. Vargo Stamps, Racine, Wisconsin.

TEN Crazy-shaped stamps, 3c with approvals. Knopp, Box 1381, Bristol, Conn.

WORLD Wide mixed 300 10c. Baker, Box 164, New Castle, Indiana.

40 DIFFERENT Commemoratives, charity, pictorials, etc., Far East, Levant, Ukraine, France, Russia, enormous catalogue value, 3 cents only to approval applicants. Monesson, 505-M Fifth Avenue, New York.

FINE Approvals, freshly mounted. Fast, personal service. Tell me what countries you prefer and I'll send their stamps. Skinner, 345 East Ocean, Long Beach, Calif.

WHOLESALE Supplements to dealers for 10c postage. Hundreds of bargains. Grossman Stamps, 102 West 42nd, New York.

FREE! Austria war set. Postage 3c. Williams, 606 Archer, Bay City, Michigan.

FREE! Pony Express set (facsimiles). Postage 3c. Roberts, 406 Building, Bay City, Michigan.

FIFTEEN Commemoratives 5c with approvals. Walker, 5130 North Williams, Portland, Oregon.

U. S. approvals. Stock 95% complete. Parks 12c. Box 488, Minneapolis.

FREE Guatemala bird set to collectors requesting approvals. Latin-American, Box 93, Hayward, California.

500 ADDRESS Stickers, 3-4 line, quarter; approvals. 127-P Washington Bridge, New York City.

FREE! 10 Commemoratives! With approvals. (Box 321), Foxlake, Wisconsin.

TEN Shilling Great Britain George VI catalogue value 60 cents, sent upon receipt of fifteen cents to those requesting our selected approvals. Philatelic Sales, Box 11, Station G, New York.

IDENTIFICATION Bracelet \$1.00. Thick Sterling Silver Tag advertised page 180.

81c POR Nothing! Scarce set of four Russian stamps cataloging 81c plus giant illustrated bargain lists. All absolutely free for the names of three friends who collect stamps. Frederick A. Fitts, Framingham, Massachusetts.

FREE! Leeward Is., Cayman Is., Turks and Caicos plus 60 different mint Geo. VI coronation poster stamps, to approval service applicants sending 3c postage. Tatham Stampco, Springfield-30, Mass.

1000 MIXED U. S. old and new 25c. Approvals. Weatherly, Amherst, Ohio.

DEALERS—Wholesale list. Postage 3c. Frank's, 4900 Chalgrove, Baltimore, Md.

UNITED States stamps on approval. We offer a select stock at reasonable prices. Over 1500 varieties on hand, including scarce 19th century issues, commemoratives, airmails, parcel post, revenues, telegrams and confederates. Write today. Southern Stamp Co., Box 70, Miami, Fla.

APPROVAL Sheets. Frederick B. Driver, 401 Finance Bldg., Philadelphia, Penna.

1000 U. S. Mixed, dime and 4c postage. Jem Stamps, Port Jefferson, N. Y.

NEW 1942 Bargain packet—Over 100 different stamps; includes strange "mystery stamp" now prohibited in United States mail; stamps you'll treasure from Azerbaijan, Georgia, Transcaucasia, etc. Complete packet for only 5c to approval applicants. Cactus Jr. Approvals, Box 1870-M, Tucson, Arizona.

BRITISH Empire collection! Burma, Cyprus, Gwalior, Sarawak, Tasmania; also 50 other British only 5c with pictorial and commemorative approvals. Lyman, 95 Nassau, New York City.

100 DIFFERENT British colonies—Stamps from the four corners of the world—Special 10c to approval applicants. Official Stamp Co., Fairlawn, N. J.

750 MIXED United States 9c postpaid. Potter, 1314-P McGee, Kansas City, Mo.

500 UNITED States for 10c! 500 U.S.A.—absolutely unpicked and unsorted—just as received from church missions. Many varieties, including commemoratives, airmails, high values up to \$5.00 denomination! Price only 10c to approval applicants! Money back if not delighted. Swan Stamp Co., Dept. 69B, Dunkirk, N. Y.

UNITED States approvals complete coverage, fine quality, attractive prices. Seminoles Stamps, Box 436, Coconut Grove, Florida.

60 DIFFERENT U. S., including commemoratives, airmail 10c. No approvals. Seidenberg, Baroda, Mich.

WEEKLY Stamp magazine, thirteen weeks, 10c. Stamp Journal, Kalamazoo, Mich.

50 ASIA 10c. Big 50% discount approvals. Coverts, 39 State St., Rochester, N. Y.

WOW! \$10.00 Worth of fun for only 10c! 500 foreign stamps, unsorted and unpicked (mostly on bits of paper) just as received from the church missions and other sources. Africa, So. America, Australia, China, Philippines, Dutch Indies, and other countries are represented. Includes a few commemoratives, airmails, and stamps cataloging up to 25c or more each! The biggest package of fun in stampdom—and you might find something really valuable! Price only 10c to serious approval applicants! Money back if not delighted. Jamestown Stamp Co., Dept. No. 22, Jamestown, New York.

A REAL Bargain. Specially prepared packet containing 150 different foreign and 65 different U. S. stamps; catalog value about \$5.00; pamphlet which tells you "How to Make Your Stamp Collection Properly" and large bargain lists, all for only 23c postpaid. Queen City Stamp Co., Room 36, 604 Race St., Cincinnati, Ohio.

\$1.00 (CAT. Price) for 1c! Two mint U.S.A., cat 20c; "queer countries" packet (Djibouti, Manchuria, etc.); scarce set Russia, cat. 75c. Everything for only one cent to approval applicants! Garelson Stamp Company, Box 400, Calais, Maine.

SMOKY Mountain commemorative sheet, largest U. S. stamp issued, and 33 U. S. including commemoratives, airmail, revenues, etc. Catalogs 75c—To approval applicants for 5c. Curhan Stamp Company, Gloucester, Mass.

SOUTH American—100 different 10c—with approvals. Davis, Silver Lake, Ind.

WILL Rogers and U. S. flag—Panama showing "Old Glory" in natural colors, and Nicaragua Rogers' diamond and triangle stamp, North Mongolia diamond (world's largest), Pope Pius "peace" stamp, slave colony, genuine Far Eastern Republic, Thailand, Antipodes "puppet" country, animals, airmails, etc., all 5c with approvals. Belmont Stamp Co., Dept. 8, Washington, D. C.

CANAL Zone—Panama Canal commemorative and Ecuador with U. S. flag in natural colors, also "bullfight" stamp, Chinese "midjet," giant diamond, "Christ" triangle, "earthquake" airmail, Mozambique, Morocco, Ex-Nazi colony stamps showing giraffe, Royal Air Force pilot, etc.—all 5c with approvals. Potomac Stamp Co., Dept. 1, Washington, D. C.

STAMP Dealers, your ad here will bring wonderful returns. Ask me for proof. F. W. Johnson, Manager, Classified Advertising, Popular Mechanics Magazine, 200 E. Ontario St., Chicago.

GIANT Packet 136 all different from Africa. South America, South Sea Islands, etc. Includes Nicaragua airmail, two scarce unused United States cataloging 20c. triangle and animal stamps; many others. Also includes fine collection 25 different British Colonies—Charkari, Jamaica, Johore, etc. and United States \$4 and \$5 high values. Total catalog price over \$4.00! Everything for only 5c to approval applicants! Mystic Stamp Company, Department 80-A, Camden, New York.

SEND Postage for free United States price list. Stanley Gibbons, 38-P Park Row, New York.

CANADA 100 Different 25c—approvals all countries. Lists. Victoria Stamp Co., London, 4, Canada.

PENNY Approvals, that satisfy. Neil Gronberg, Box 5441-P, Philadelphia, Penna.

ZEPELIN And 24 airmails 5c with approvals. Paltra, Fordham Station, New York.

COINS, TOKENS, CURRENCY

\$2.00 TO \$500 Each paid for hundreds of old or odd coins, wanted by collectors. Get posted at once. Send ten cents for illustrated coin value book, 4x6. Buying and selling prices guaranteed by us. 35 years in business. Coin Exchange, Box 5, Le Roy, N. Y.

50 DIFFERENT Coins, \$1.00. Oddehon, Box 44 Overland, St. Louis, Mo.

CENTS 100 Years old 25c, 10 different Indians 25c, large handbook of coins 50c, lists 3c. Coin Shop, Alameda, Calif.

COIN Card collector's our price list is free. Write Hanson's, 1326 Main, Kansas City, Missouri.

OLD Money wanted. Do you know that coin collectors pay up to \$100.00 for certain U. S. cents? And high premiums for all rare coins? We buy all kinds. Send 4c for large coin folder. May mean much profit to you. Numismatic Co., Dept. 20, Fort Worth, Texas.

OLD Money wanted. Big premiums paid. Catalogue 10c. Allan Appell, Sedalia, Missouri.

50,000 COINS, Medals, papermoney, Confederate bonds. Lists free. Nagy, P-8 South 18th, Philadelphia, Penna.

COMMEMORATIVE \$1/2s, Columbia, Lincoln, Stone-Mountain, Long-Island, Cleveland; \$1.00 each. Large illustrated catalogue 25c. Norman Shultz, Salt Lake, Utah.

GET Profit and pleasure in collecting old coins. Send 10c for 56-page illustrated coin catalog. You'll be delighted with it. Send for it now. B. Max Mehl, 370 Mehl Building, Fort Worth, Texas. Largest rare coin establishment in U. S. Established 42 years.

FREE! Foreign coin, banknote and large 50 page illustrated coin catalogue to approve service applicants. Send 3c postage. Tatham Coinco, Springfield-125, Mass.

I MAY Have just the scarce U. S. coins you want. Send me list. "Meet me by mail." William H. Kenworthy, Waterville, Maine.

PRICE List of U. S. coins, bills and collectors' accessories 10c. 75 illustrations, 2500 quotations. James Randall, 341 South Dearborn, Chicago.

10 INDIAN Head cents, different dates, also preclists 35c. Schultz, 1053 Richmond, Cincinnati, Ohio.

HOBBIES AND COLLECTIONS

MATCH Book albums—free booklet. Matchless Album Co., Dept. P, Long Branch, N. J.

ART Studies—Magazines, courses, books. Catalog 10c. Ciccone's, 863(P) First Avenue, New York City.

ZIRCONS White diamond cut, 3 for \$3.50 (2 carats); 3 smaller genuine fancy sapphires, \$3.50. List. Leuthold, 2227 1/2 No. Alabama, Indianapolis, Ind.

"BAG Of Gold." Real rock that defies experts. Startles everybody. Great for hobby fans. 25c. Truitt, 37 West 8th, Columbus, Ohio.

BEAUTIFUL Jewelry stones removed from rings, etc. 200 assorted \$2.00. Lowe's, Box 311, St. Louis, Missouri.

EXCHANGE Your duplicate stamps, match covers, etc. with collectors everywhere. List, swappers, dime. (Mention hobby.) Secretary, Box 2186, Denver, Colo.

HOBBY Books—Latest titles—Bargain catalog free. Popular Mechanics, 633 St. Clair, Chicago.

CAMERAS, PHOTO SUPPLIES

PRECISION Repairs: Cameras, synchronizers, shutters, range finders, exposure meters. Prompt service, moderate rates. Camera Technicians Co., 521 Fifth Avenue, New York (Dept. H.)

CAMERAS And supplies. Free illustrated catalog listing everything photographic—still and movie cameras, films, lenses, enlargers, meters, supplies—at tremendous savings. Hundreds of bargains. All guaranteed. We take your old camera or equipment in trade. Write now for your free copy of our newest money-saving bargain book—just out! Limited edition. Hurry! Central Camera Co., (Photographic Headquarters since 1899), 230 S. Wabash Ave., Dept. E-16Z, Chicago, Illinois.

CAMERAS Bought, sold, exchanged. Bargains in new, used, trade-ins, demonstrators, etc. Speed candid with built-in flash low as \$8.95. Leicas, Contax, Graflex, movie outfits, etc., at like savings. Hundreds of values to choose from. Bargain list free! Powell's, 155 W. Randolph St., Chicago.

HAVE You a camera? Send ten cents for recent number of our big magazine, showing how to make better pictures and earn money. American Photography, 116 Camera House, Boston, Mass.

SPECIAL Price—Limited time. The Camera—a practical photographic magazine with a new monthly Defense Bond Contest. Trial subscription six issues for \$1.00. The Camera, 305 N. Charles Street, Baltimore.

35MM. Film! 25 ft. Eastman Plus X \$1.00! Reloaded cartridges—3 for \$1.00 postpaid. Order now. Pacific Coast Film Co., 1510 N. Sierra Bonita, Hollywood, Calif.

COLOR Snapshots lifelike! Inexpensive. Complete instructions—25c. Bx 102, Austin, Texas.

CAMERA Repairing. Bellows made to order, shutters repaired. Bellows made to fit all standard cameras! United Camera Co., Inc., A-1515 Belmont, Brooklyn, N. Y.

SPEED-O-COPY Groundglass focusing attachment for Leica, Contax, Argus C-2 and C-3. Send for literature. D. Paul Shull, Dept. PM-3, 240 So. Union Ave., Los Angeles, California.

TREMENDOUS Saving 100' bulk double 8mm. nonhalation film \$1.25. Comes packed on three spools that fit all double 8mm. cameras. 100' 16mm. nonhalation processing included \$1.98. Ambassador, 479-A Quincy Street, Brooklyn, N. Y.

BASS Says: Astounding buy, exclusive here, latest Argus C3 with coupled range finder, synchro flash, 50 mm. F:3.5 lens, also 75 mm. Bausch & Lomb telephoto F:5.6 also coupled to range finder, \$82.50 value; price \$60.50, unconditionally guaranteed. Cowhide Eveready case, \$4.75. V. P. Ihagee Deluxe, F:4.5 lens, Prontor shutter, big value at \$18.75. Send for yours quick while they are available. Write for quotations and advise what you have to trade. We pay cash for good cameras, lenses, binoculars. Don't trade until you write Bass Camera Company, Dept. AG, 179 W. Madison St., Chicago.

SOLAR Enlargers for prize winning prints. Amazing performance. Enlarging treatise free. Ask your dealer. American made by Burke & James, Chicago, Illinois.

MAKE Money in photography. Learn quickly at home. Easy plan. Previous experience unnecessary. Common school education sufficient. Booklet and requirements free. American School of Photography, 1315 Michigan, Dept. 3432, Chicago.

OIL Coloring photographs a fascinating hobby or profitable business. Learn at home. Easy simplified method. Previous experience unnecessary. Send for free information and requirements. National Art School, 1315 Michigan, Dept. 3441, Chicago.

PHOTO FINISHING

BETA-WORK For only 25c more: Extra quality, extra care—finest developing, outstanding enlargements (3 1/4 x 4 1/2). 35mm. 36 exposures \$1.25—18 exposures \$1.00—12 and 16 exposure splits 75c—bantams 50c—Folder free. Beta Photo Laboratories, Box (B)745, Grand Central Annex, New York, N. Y.

35MM. Argus, Leica, etc., (except "Mercury") 36 exposure rolls, fine grain developed (Eastman DK-20) and beautifully enlarged to 3" x 4" glossy prints, 90c. Cartridge reloaded with Eastman Plus X, 35c. 18 exposure rolls, 55c, reload 20c. Films permanently protected by revolutionary Cryolite process. 24-hour service. Satisfaction guaranteed. Free mailing bags, sample print. Photo contest! Valuable prizes. Request entry blank. Write Technifinish Laboratory, 610 Brown St., Rochester, N. Y.

BIGGEST \$1.00 Value in 35 mm. finishing today. 36 exposure fine grain 3 1/4 x 4 1/2 enlargements; deckled, embossed margin and date. Eighteen exposures 75c; sixteen exposure splits 55c. Free mailers. 8 exposure rolls in beautiful deckled contact finish with free handy album 25c. Mailbag Film Service, Box 5440A, Chicago.

TWO Beautiful prints from each picture on roll 25c. Twenty-two years of satisfied customers. Quick service. Lens Photos, Dept. J-4, Janesville, Wis.

THREE Prints each good negative. 6 to 8 exposure rolls, 30c. 12, 16, 18 exposure rolls, 50c. Reprints, 3c. Fred D. Eastman, Bode, Iowa.

REPRINTS 20 For 25c, 50 for 50c. Queen City Service, Dept. 8, Box 7, Niagara Square Station, Buffalo, N. Y.

BEAUTIFUL Enlargement from each picture on roll 25c. Cut Rate Photos, Dept. B-4, Janesville, Wis.

ROLL Developed, photo album, 2 enlargements, 8 prints, 25c. Wards Studio, 386, Des Moines, Iowa.

QUALITY Developing—Prompt service. 6-8 exposure rolls, two each. Free enlargement coupon 25c. Postcard brings mailer. Pety Studios, 3310 W. 65th Street, Chicago.

DOUBLESIZE Prints. Your roll developed and 8 doublesize prints 25c; from 116 or 120 size negatives you receive 4x6 inch prints. All other size negatives printed in proportion. 18 exposure rolls 50c; 12 exposure rolls 35c. Reprints 3c each. "Our guarantee." Everlasting hi-gloss finish. Overnight service. Pacific Photo Service, Box 666, San Francisco, Calif.

EIGHT Prints, two enlargements 25c. Quality Picture Co., Box P-3573, Portland, Oregon.

OIL-COLORED 5x7 Enlargement 25c. Small size 20c. Send negatives. Arlette Studio, 41-31 47th St., Long Island City, N. Y.

ROLL Developed, 8 brilliant Fadeproof Velox prints and two professional enlargements 25c. Overnight service. Young Photo Service, 405-C, Albany, N. Y.

VELOX Quality prints! Roll developed, two prints each negative. 30c. Reprints 2 1/2c. Hench Studios, Harrisburg, Penna.

ROLLS Developed double set prints 25c. Reprints 25c dozen. Enlarged 16 exposure 45c, 36 exposure 85c. Reduction on new rolls. Eshlemans, 120-08 Liberty, Richmond Hill, N. Y.

SIXTEEN Beautiful Hollytone prints with eight exposure rolls developed—25c. Hollytints, P-1350, Hollywood, California.

EXCLUSIVE Introductory offer! 4 beautiful enlargements for 10c. Send any 4 negatives of the same size (up to 2 1/2" x 4 1/4") and we will return to you immediately 4 valuable enlargements—deckled and dated on Velox. Negatives returned with order. Send negatives, this ad and 10c coin today. This ad must accompany order. Mail-N-Save, Box 316-29, Quincy, Massachusetts.

COLOR Puts new life into your pictures. You'll be delighted with our Toned Monochromes compared with black and white. Special: Send five favorite negatives, \$1.00, for enlargements heavy 8 1/2 x 11 1/2 paper, plate sunk border, toned red chalk, blue, green, magenta, brown. Take no chances. Have your films fine grain processed by professional workmen long experienced in technical and artistic quality controlled results. 8 exposures processed, 8 projected 3x4 prints, one toned enlargement 35c. Contact reprints 3c. American Film Processors, Box 547, St. Louis, Mo.

YOUR Choice: 8 enlarged prints (nearly post card size) or 16 regular size prints from 8 exposure roll or negatives 25c. Willard Studios, Box 3536D, Cleveland, Ohio.

PHOTO Stamps! Any snapshot reproduced stamp size, gummed, perforated, 100 for \$1. Lawrence W. Kiley, Birmingham, Michigan.

35MM. FILM Developed in DK-20 and enlarged to 3 1/2 x 5, \$1.50. (18 exp.—\$1.00.) Stanley Studios, Box 760, Atlanta, Ga.

THE Photo Mill. Immediate service! No delay! Eight exposure roll developed, printed and coupon for your choice of two beautiful 5x7 professional enlargements, one tinted enlargement, eight reprints or other premiums, for 25c coin. Developing and eight Jumbo prints 25c coin. The Photo Mill, Box 629-12, Minneapolis, Minnesota.

20c FILMS Developed and printed on deckled velox paper, 6 or 8 exposure, returned same day. Nellmar, Box 4088, Richmond, Va.

EVERY Picture an enlargement! 8 sparkling deckle-edge enlargements and roll developed 25c coin; 116 size or smaller enlarged reprints 3c. Enlarge Photo, Box 791, Dept. PM, Boston, Mass.

READY-TO-FRAME Enlargements, 5c! Hand colored, 20c!—from your negative. 16 reprints your negatives, 25c. Kodak roll developed with 16 guaranteed deckle-edge Velox prints, 25c! 36 exposure 35mm roll developed, vaperated, enlarged to 3x4, \$1.00! 3x4 reprints, 3c each. Immediate service! Free mailers! American Studios, Dept. 310, Lacrosse, Wis.

SPECIAL Limited offers! If you enclose this advertisement, 4 enlargements from 4 negatives 10c coin; folio enlargements 18c each postpaid. Enlarge Photo, Box 791, Dept. PM, Boston, Mass.

ROLL Developed and 16 prints, or 8 prints and 2 enlargements, 25c. Candid 35mm. film developed and 36—3x4 prints, \$1.00. 18 exposure roll, 60c. Mercury Studios, Dept. 21, 109 N. Dearborn, Chicago, Ill.

ROLLS Developed two prints each and two free enlargement coupons, 25c; reprints 3c each; 100 or more 1 1/2c. Summers' Studio, Unionville, Mo.

ROLL Developed and 4x6 oversize glossy Velox prints, 8 exposure 30c; 12 exposure 45c; 16 exposure 60c. Overnight service. Clemet Photo Service, 1318 W. Columbia Ave., Philadelphia, Penna.

16 BEAUTIFUL Overseas deckled prints and two enlargements with first order 25c. Owlphoto M1, Weatherford, Oklahoma.

PHOTOGRAPHY For pleasure and profit. Prepare at home. Common school education sufficient. Write for information and requirements. American School of Photography, 1315 Michigan, Dept. 3451. Chicago.

OIL Coloring photographs a fascinating hobby or profitable business. Learn at home. Easy simplified method. Previous experience unnecessary. Send for free information and requirements. National Art School, 1315 Michigan, Dept. 3431. Chicago.

FOR The discriminating amateur—3 exposure rolls. 2 prints each 25c. Miniature rolls enlarged 3 to 6 times. 8 exposures 25c. 16 exposures 50c. 35mm. 36 exposures, 3x4 enlargements \$1.00. Unexcelled quality. Prompt service. Paramount Photo, 1583 First Ave., New York.

EIGHT Beautiful enlarged prints (nearly postcard size) or 16 regular prints 25c. 35mm. rolls enlarged 3 1/2 x 4 1/2 \$1.00. Burton Studios, 443M, Roscoe, N. Y.

PHOTO Enlarger—Make it yourself. Costs little. Simple to make. Illustrated instruction book 25c. Popular Mechanics, 200 E. Ontario Street, Chicago.

IDEAL Photos beautifully finished wide border deckle edge. 25c roll of 8 and free enlargement. Ideal Photos, Box 2255, Paterson, N. J.

ROLL Developed and 8 lustrous distinct finish permanent Velox glossy prints 25c—reprints 3c each. Fotoprint Service, Box I, Roanoke, Virginia.

16 SPARKLING Lifetone prints, 2 beautiful Hollywood enlargements, free Leather-tone frame and photo wallet only 25c. Free photo album with first order. Lifetone Studios, Dept. A-339, Des Moines, Iowa.

8x10 SILK Finish enlargement—25c. Send negative. Irving Studio, 4006A Irving Park, Chicago.

MOTION PICTURES AND SOUND EQUIPMENT

BULK Movie film—8-16mm. Big savings. Fine grain, non-halation. Plans for building movie processing outfit with all formulae, 25c. Also bargains in accessories. Write for free circulars and film sample. Superior, Dept. D-5, 188 W. Randolph, Chicago.

VICTOR 16mm. Sound on film projector good condition \$150.00. Also Simplex magazine loading 16mm. camera, 3.5 lens \$40.00. Doris Weber, Webster, N. Y.

16MM. SOUND National anthem trailer \$4.95; Victor sound projector complete \$189.50 (terms \$2.42 weekly). 8x10 portable professional screen, with collapsible stand, (reg. \$125.00) \$34.95. 16mm. sound projectors bought, sold, exchanged. Terms. Nationwide circulating film library 16mm. silent, sound; 8mm. Mogull's, 64 West 48th, New York City.

WANTED: Used equipment for cash. Films, cameras, projectors, etc. Peters, 41-C South Fourth, Allentown, Penna.

MOVIE Films—Cheap! Free catalogue! Superior, 126 Fourth, Paterson, N. J.

AMBITIOUS? Show talkies theatres less communities. Sound equipment. Weekly programs rented reasonably. Roshon, State Theatre Bldg., Pittsburgh, Penna.

8-16-35MM Films. Bought, sold, exchanged. Catalogue, sample film 10c. International, 2120 Strauss, Brooklyn, New York.

8MM.-16MM. Latest news reels. "Normandie on Fire"; "Japs Bomb Pearl Harbor"; "Russia Stops Hitler." Champion fights—Joe Louis and others. Silent-sound. Films rented everywhere. Free catalogue, (sample film 10c). Garden, 317 West 50th, New York.

8MM-16MM Films. Free catalogue (sample film 10c). Parkway Exchange, 961 Eastern Parkway, Brooklyn, New York.

35MM. Odd reels 75c. Projectors. Features. Savarese, Woodcliff Lake, N. J.

SAVE 50% On movies. Bargain circulars. Genera Company, Davenport, Iowa.

BARGAINS! 35mm. films. Silent. Sound. Demsey, 1223 Berkley, Youngstown, Ohio.

ATTENTION Movie fans! Selling out 16mm. library films—"like new," (approximately 400 feet), \$3.50 per reel. Garden, 317 West 50th, New York.

FREE. 1942 Movie list; samples 10c. Goodwill Company, Jackson, Tennessee.

REDUCED! 16mm.-8mm. Releases. (Illustrated catalogs, dime.) Megifilms, 340-V West 29th, New York.

SEND Stamp for 16mm., 8mm. catalogue. Sterling's, 679 Northampton, Easton, Pennsylvania.

USED 16MM. sound film—100 feet, \$1.00, postpaid. Blackhawk Film, Davenport, Iowa.

BASS Says: Shrewd buyers send for the new Bass Cine Bargaingram No. 245, an 84-page catalog exclusively cine. The new Revere Double 8 with F:3.5 lens at \$38.50. Is the buy. The RCA 16mm. S.O.P. news reel camera at \$275.00. Write Cine Headquarters for your copy of this great free book. We pay cash for good used movie equipment. Bass Camera Company, Dept. A, 179 W. Madison St., Chicago, Ill.

FILMS Exchanged; bargain lists 3c. Hoffman Cut Rate Films, 57 Broad, Albany, N. Y.

ASTONISHING. Exotic Kodachrome subjects. Lists, sample, dime. Erwine's Enterprises, Allentown, Penna.

LEARN Movie projection, management. Free catalog. Give age. Theatre Institute, Elmira, N. Y.

NATIONALLY Advertised 8mm.-16mm. movie cameras, projectors, films. Cash or terms. Send stamp for catalogue. Don Elder's, M-739 Boylston St., Boston, Mass.

MUSIC AND MUSICAL INSTRUMENTS

SONGWRITERS! Amazing, convincing offer. Hibbeler, C-5, 2157 No. Avers, Chicago.

MELODY Writers: Fine commercial piano arrangement \$5.00. Lon (Nevada Moon) Healy, Colorado Springs, Colo.

SONG Hits! Send poems for free examination. Write for free de luxe rhymery. DeLuxe Music Service, Box 3163-P, Bridgeport, Conn.

SONGWRITERS—Send poem for immediate consideration and free rhyming dictionary. Richard Brothers, 24 Woods Building, Chicago.

LYRICS Wanted, song composed. Beginners proposition. Basil Alt, Ottoville, Ohio.

SWING Piano by ear!—Write your own songs. Fascinating new method by popular Hollywood swing pianist-composer. Free details. Write today. Harmony House, 715D Haas Bldg., Los Angeles, Calif.

SONGS—Composed, arranged. Complete Song Service, Box 113, Kalida, Ohio.

LEARN Popular piano! Write Magic Key, 111-A Broadway, Glendale, Calif.

SONGS—Song poems wanted. No charge for melodies. Free examination. Hollywood Recording Studios, 87 G16 Preuss St., Los Angeles.

PHONOGRAPH Records 10c. Catalogue. Paramount, AV-358 East Market, Wilkes-Barre, Pennsylvania.

GOOD Music composed to good words. Reginald Belcher, Chatham, New Jersey. Established 1910.

SONG Poems wanted. Submit for consideration. Five Star Music Masters, 630 Beacon Building, Boston.

NEW And used accordions and wind instruments bought and sold. Complete factory repairs on all instruments. Ace Music Co., 307 So. Wabash Ave., Chicago, Ill.

SONG Poems wanted for musical setting. Free booklet. Write today. Song Service, 331-C West 46th, New York.

SONGS. Poems wanted. Newark Song Publications, 1207 Carbon, Syracuse, N. Y.

PHONOGRAPH Records 10c. Free list. Hoodwin Company, 4419 Broadway, Chicago.

SONGWRITERS—Write for free book. Send song poems. Variety, Salem, Ind.

SONGWRITERS! Words, melodies. Amazing offer. Hibbeler, C-5, 2157 No. Avers, Chicago.

SONGWRITERS. Write for free booklet. Profit sharing plan. Allied Music, 7608 Reading, Cincinnati, Ohio.

WANTED! Lyrics, melodies for songs. We arrange, publish, sell. Superior Song Studios, Passaic, N. J.

MUSIC Composed to words. Wonderful proposition. Bauer Bros., Oshkosh, Wis.

LEARN Swing piano! Postal brings free folder. Christensen, 451 Kimball Hall, Chicago.

MUSIC Composed to words. Rhyming pamphlet on request. Phonograph recording of completed songs. Send poem for consideration. Keenan's Studios, Dept. PM, Box 2140, Bridgeport, Conn.

SONG Poems wanted. Free examination. McNeil, Master of Music, 510-PM South Alexandria, Los Angeles, Calif.

WRITE Songs. Big money and reputation. Write for information. J. Gordon Pub. Co., 201 N. Hoyne, Ave., Chicago.

RADIOS, SUPPLIES, INSTRUCTION

RADIO Communication course for home study. Covers all phases of operator license and job requirements. Free circular No. 3M. Nilson Radio School, 51 East 42nd St., New York.

COMMERCIAL And amateur radio licenses speedily obtained through non-mathematical, easily understood, home study radio course. Moderate tuition fee. American Radio Institute, 1123 Broadway, New York.

MAKE Simple long distance pocket radios. No tubes, batteries. Special offer: Two sensitive crystals and complete illustrated instructions 25c, postpaid. Allen, PM-427, Clinton, Mo.

REVISED Plans 18 distance crystal sets, with "Radiobuilder"—year, 25c. Laboratories, 1406-C 77th Avenue, Oakland, California.

RADIO Service men and experimenters send for our giant radio catalog. Save dollars. United Radio Co., (1000 M.) Newark, N. J.

MONEYMAKING OPPORTUNITIES

DOUBLE Your present earnings! 64 pages of "Mail Order Flashes" plus 64 pages of business "boosters" plus 64 pages of "Selected Opportunities"! \$3.00 value! All for \$1.00. National Publishers, 546 Washington Building, Los Angeles, Calif.

25 WAYS To make money drawing and copying cartoons. Hamilton, Box 4, Woolsey Sta., Astoria, N. Y.

BOOKKEEPERS (Experienced) for profitable accounting work. Ralph Lee, Vicksburg, Michigan.

MILLION Articles. Buy wholesale. Valuable directory 10c. Ideal Service, D-5, Park Ridge, Ill.

WIN With "Schemer" schemes. Six copies, totaling 288 pages, just 30c. Paterson, Publisher, Alliance, Ohio.

EARN Money with your typewriter addressing envelopes, circulars, typing. Information 10c; none free. Ace-PMN, Box 1123, Birmingham, Ala.

BECOME Cartoonist overnight! Make extra money! Write National Artists, 801-M North Marsalis, Dallas, Texas.

REFINE Old lubricating oil. Also how to convert into cheap motor fuel. Plans 59c each, both \$1.00. Wayne Engineering, Box 13, Greenville, Ohio.

MAKE Money by mail. Stamp brings facts. Graham, Real Estate Trust, Philadelphia.

EARN Money at home! Thousands do! "Home Worker Magazine" tells how. Sample, 25c. Sizemore, Box 7, 4917 North Kostner, Chicago.

EARN Money mailing, 100% profit; 50c sample, instructions. Ace Products, Wilkes-Barre, Penna.

DOLLARS. Quarters, dimes by mail! "Reliable Homework Tips" shows how. 10c (coin or defense stamp) brings sample; details. Colemans, Smithboro, N. Y.

CASH In on silk shortage. Sell Silk Save. A mail order "natural." Sample, information dime. Karmo, Forest Park, Ill., Box 62.

MONEY With old oil! Easy, illustrated system. Local or by mail. Write, Central Industries, Simpson, Kansas.

WILL You give us 5% first \$600 you make? Afternoons free! Work home. \$1,000 month reported (exceptional—full-time). Expect surprise! National, Box 1240, San Bernardino, Calif.

MAKE Money easily, pleasantly with roadside stand. Write Fame-s-System, Lathrop, Calif.

EARN \$5.00, \$50.00 Evenings. Editors begging personal-experiences. Education unnecessary. Complete instructions 50c. Western Publishers, 409 Malaga, Wenatchee, Washington.

WHOLESALE Sources. 500,000 articles. Free directory. Maywoode, 1133 Broadway, New York.

BE A metascientist. Remarkable drug-less healing system. No manipulation, no apparatus. Inexpensive correspondence course. Free information. Metascience, Deland, Florida.

YOU'LL Like resilvering mirrors, tableware, making chipped glass nameplates, signs, Outfit prices. Sprinkle, Plater, 287, Marion, Indiana.

BUSINESS OPPORTUNITIES

INCORPORATE Your business. Many advantages. Write today. Free details. Tax Research Bureau, Inc., Box 1472-R, Wilmington, Del.

HANDY Men—Earn money home operating Community "Fix-It" Shop. Stafford, 708 Rawlings, Carbondale, Illinois.

START Home business making statuary, plaques, art goods, novelties, souvenirs, concrete pottery, garden furniture, artificial marble flooring, liquid marble. Make your own flexible molds. Amazing profits. Valuable folder free. Creative Publishers. (PM5), Glencoe, Illinois.

MAN To assemble and sell my plywood rowboats in spare time. I furnish material, parts, instructions. Write today for big money making proposition. C. R. Dillabaugh, 7931 Mallory, Portland, Ore.

CAPITAL Seekers—Interested in raising \$25,000 or more for a legitimate project should communicate with Amster Leonard, Fox Theater Bldg., Detroit, Michigan.

DON'T Be a job hunter—Start your own business on our capital. No hard times; no layoffs; always your own boss. Hundreds average \$3,000 to \$5,000 annual sales year after year. We supply stocks, equipment on credit. 200 home necessities. Selling experience unnecessary to start. Wonderful opportunity to own pleasant, profitable business backed by world wide industry. Write Rawleigh's, Dept. E-U-PPM, Freeport, Ill.

MAKE Statuary, flooring, etc. Imitation marble formula 25c. Ideal Service, 5M, Park Ridge, Ill.

VALUABLE Progressive mailorder plans, latest moneymaking ideas. Magazines, 25c. Gentilucci, 247 West 21st St., New York City.

FREE—200 Clever mail order, home-work, local business offers—all snappy moneymakers. Lewis Co., 828-M Carpenter, Oak Park, Illinois.

START Your own business. Outstanding opportunity. Wall Monuments, Zanesville, Ohio.

ARTISTS! Cartoonists! New folio shows 75 ways to make money in art. Complete \$1. Denes, 170 M Fifth Avenue, New York.

MAKE Your own Flexible Molds. Statuary, Art Goods, Novelties, Artificial Marble Flooring, Liquid Marble. Literature free. Kemico, 105-M, Park Ridge, Ill.

GRIND Lawn mowers! Factory process. \$800.00 reported! \$2.00 capital. Mowers, Janesville, Wis.

TOO Old for job? Your own business makes future secure. Drop postal for over 100 moneymaking ideas. Mantoman, Box 1014, Hollywood, Calif.

CONVERT Tin cans into steel scrap, valuable tin, by chemistry. Process and sample \$1.00. Forty formulas 50c. Harry D. Cater, 455 Washington St., Denver, Colo.

STATUARY: Make all kinds. Simple process. Make and install artificial stone flooring in color. Liquid marble. Other money-makers. Write promptly for quick start. Compo-Tex, Box 786, St. Louis, Mo.

POR An extremely profitable lifetime business, operate a collection agency-credit bureau. Many make \$4,000 yearly. up. Write, Cole Associates, Syracuse, N. Y.

SIGNS And showcards easily and expertly painted with letter patterns. Many sizes and styles. Write for descriptive folder. John Rahn, A1330 Central Ave., Chicago.

MAKE Money by mail, the way we do. Free information. Maywood, 1133 Broadway, New York.

GO Into business. Achieve ambitions, make plenty money, be commercial giant. Free circular. Green, 622-A Box St., Buchanan, Mich.

EXTRA Income—Plenty mail selling opportunities. Write Katz, 4254 N. Kimball, Chicago.

MAKE Artificial marble, glazed tiles, plaques, moldless pottery, sanitary flooring, chemically stained cement. Uncanny, inexpensive. Superhard figurines, novelties, whetstones. Brilliant samples 3c. Payn, 945 Grande Vista, (Room 101.) Los Angeles, Calif.

MANUFACTURE And sell vanilla extract. Non-alcoholic formula \$3.00. Sample and particulars 25c. Guaranteed to repeat. Eli Johnson, Pharmacist, Griffin, Ga.

COLOR Concrete with chemicals. Washing wells. Stucco-rock. Benches. Spin concrete pottery. Cement artistry. Garden ornaments. Cold glaze. Concrete paints. Marbling. Sample 10c. Hollywood Cement Craft, 8527 Wonderland, Hollywood, Calif.

MECHANICALLY Inclined men—Own and operate general appliance repair shop. Complete, illustrated course shows you how. Welding, refrigeration, motor repair, how to get business, etc., all phases covered. Free literature. Christy Supply, Dept. 116, 2885 N. Central Ave., Chicago.

SAVE Rubber! Punctureproof your inner tubes. Easy. Inexpensive. Start profitable business. Instructions—dollar. Bx 102, Austin, Texas.

MANUFACTURE War-time necessities! Everybody buys. Investment small, profits great! Miller's Chemists, Tampa, Florida.

DANDELION Death. Make-sell. Profit 1,000%. Other manufacturing processes. Thermicide, Peoria, Ill.

"RED Hot." Sensational new postcard plan 25c. Fastest order-puller ever devised. Amazing results. Carl Bohman, Box 428, Schenectady, New York.

HOW To sell by mail without capital investment! Books, formulas, specialties! Big profits! Send 25c for 48-page magazine with particulars. National Publishers, 526 Washington Building, Los Angeles, Calif.

MONEY Making business starters. 25c brings this dollar book while they last. Hurry. Joslin, Box 9, Sta. H, New York.

MAKE Good money compiling names. Cash in advance for lists. Inexperience, location no handicap. Stamp. Darnell Service, Dept.-A, Jackson, Tennessee.

MANUFACTURE—Wood plastics. Gifts, plaques, novelties. 90% profit. Material, molds, instructions, furnished. Sample mold, 6" model nude girl statue, with illustrated molding circular, catalogue 150 new flexible molds, \$1.00 stamps or bill. Plastic Wood, 4818 Bell, Chicago.

SIGNS—Every business a prospect for advertising made in your own home. Send 25c. Pontiac Advertising Studios, 51 North Parke B, Pontiac, Michigan.

PROFITS Galore; News Bureau System, 25c coin. Twin City News Bureau, Box 1146, Minneapolis, Minn.

EXTRA Cash. No selling. Operate ball games, nut vendors. Also snappy girl film machines. Special hand viewer—28 girl pictures \$2.00 postpaid. Catalog free. Automatic, 2422A Fullerton, Chicago.

OPERATE Mail order business at home. Details dime. Maples, 3418 South Marshfield, Chicago, Illinois.

SPECIALTY Manufacturing — 1000% profit! Formulas especially designed small businesses. Little capital, no machinery. Brochure free! Victor K. Race, Norwalk, Connecticut.

INVENTORS: Foresighted manufacturers already planning post-war sale of new non-military products. If you have a useful invention, patented or unpatented, write Chartered Institute of American Inventors, Dept. 4-C, Washington, D. C.

PROFITABLE Spare time opportunities, start without capital. Stamp please. Clement, 439 Arthur, Rochester, N. Y.

MAKE Money metallizing baby-shoes, plaster, plastics, flowers, wood! New non-priorities methods! Simple, profitable, fascinating! Free particulars. Novelty Metallizers, Box 933-M, Church St. Annex, New York.

WILL You give us 5% first \$600 you make? Afternoons free! Work home. \$1,000 month reported (exceptional—full-time). Expect surprise. National, Box 1240, San Bernardino, Calif.

MEN—Women. Start candy kitchen in your home. Full or sparetime. Big profit. Folder free. Thompson Co., Baldwin, Michigan.

\$50.00, \$100.00 **WEEKLY** Using sawdust. Stamp please. Clement, 943 Arthur, Rochester, N. Y.

GOOD Paying business silvering mirrors, plating autoparts, reflectors, bicycles, bathroom fixtures by late method. Free particulars and proofs. Gunmetal Co., Ave. H, Decatur, Ill.

FREE—Big list of helpful books. Popular Mechanics Press, 200 E. Ontario St., Chicago.

ELITE Collection of business plans, contains 127 tested plans and scores of formulas. Start own business; home office. Particulars free. Elite Co., 214 Grand St., New York.

NO Rebore, no rings. Stop oil pumping. Raise compression. Write for sample. Manufacturers wanted. Xralite, 10 Pine Street, Kallispell, Montana.

PLASTEX Industries offers industrious men an opportunity to start a business of their own, manufacturing art goods, novelties, souvenirs, etc., in Plastex and marble imitation. 5c material makes \$1 articles. Rubber moulds furnished for speed production. Small investment brings good returns. We are now placing big chain store orders with manufacturers. Write for interesting booklet mailed free. Plastex Industries, Dept. A, 1085 Washington Ave., New York.

HOW And where to obtain capital. Fully explained, particulars free. Star Service, Wapakoneta, Ohio.

POPCORN And potato chip machines. We help start men and women in business. Long-Eakins, 1960 High, Springfield, Ohio.

LIQUID Marble—Colorful, glazed! Mold, brush, spray! Composition floors, rubber-elastic molds. Particulars free. Marbleizing Service, Edwardsville, Illinois.

CHARTERS: Delaware; best, cheapest; free forms. Colonial Charter Co., Wilmington, Del.

127 WAYS To make money, in home or office, business of your own. Full particulars free. Elite Co., 214 Grand St., New York.

YOUR Ad in this space will bring amazing results. I'll prove it to you. Write at once for interesting information. F. W. Johnson, Room 300, 200 East Ontario St., Chicago.

YOU'LL Like resilvering mirrors, tableware, making chipped glass nameplates, signs, Outfit prices. Sprinkle, Plater, 127, Marion, Indiana.

2c **DAILY** Pays for New York office under your own name. Co-Operative Offices, 126 Lexington Avenue, New York.

SELL Books by mail on commission. No stock to carry. Orders come to you. Maywood Publishers, 1133 Broadway, New York.

FORMULAS, PLANS, ETC.

MAKE Fast selling products. No machinery. "Chemist Approved Formulas." Catalog free. Kemico, 12-P, Park Ridge, Illinois.

MOTOR Oil 1c gallon. Reclean used oil for profit. Formula 25c. George, 5008 Stenton Ave., Philadelphia, Penna.

ICELESS Ice! Colder; cleaner; cheaper. Instructions 25c. Duffy, Covington, Ky.

FORMULAS. Analysis, free literature. Hertzstein, 330 Charles, Grand Rapids, Mich.

"LUMINOUS Paint" shines in dark. Easily made. 150 other formulas, plans—all 25c. ("Soap-Making" 20 formulas \$1.00.) Ideal Service, 305, Park Ridge, Ill.

ANALYSIS. Duplication guaranteed. Valuable formulas. Consultation. Associated Chemists, Indianapolis, Indiana.

MANUFACTURE Own paints, fire extinguishers. Save plenty! Instructions—dollar. Bx 102, Austin, Texas.

10,000 MONEY-MAKERS! Authentic formulas, recipes, secrets. Simple compounding instructions. Supply sources. Make most anything! 924 page illustrated book. \$1.50 postpaid or C.O.D. (Foreign \$1.85). Adams Brown Company, Chestnut Hill, Massachusetts.

CHEMISTRY Laboratory apparatus and chemicals for industrial, analytical, and private experimental laboratories. Complete chemical laboratory supply service for correspondence school students. Send 3c for free 48-page catalog of chemicals and apparatus. Dept. M-43, Biological Supply Co., 1176 Mt. Hope Ave., Rochester, New York.

REAL Manufacturing formulas. Lists free. Cummings, Chemist, Gordon Ave., Syracuse, N. Y.

ELITE Formulas and plans; make and sell your own products. Descriptive booklet free. Elite Co., 214 Grand St., New York.

EXCLUSIVE "Three-in-One Plans." Formula, manufacturing, sales. Ten leaders \$1.00. Kent-Carlin, 940 Lincoln Alliance Bank, Rochester, N. Y.

CHEMISTRY

WINN'S New idea chemical kits and apparatus outfits for students, big value. Free literature and catalog of chemicals and laboratory supplies, scientific books at big discount. Send 3c return postage. JE-5 Winn, 124 W. 23rd, New York.

ANALYTICAL Chemist, formulas, chemical questions answered 25 cents. Abram Laboratories, Chowchilla, California.

MONTHLY Chemistry Magazine—sample 10c; year \$1.00. J.A.C.K., 6204N Hermitage, Chicago.

FREE Catalog; chemistry, mineralogy, biology, microscopes. Tracey Laboratories, Evanston, Illinois.

SPECTROSCOPE For quick chemical analysis \$2.50. Kutting Sons, Campbell, California.

CHEMICALS—Small quantities, apparatus. Catalog 5c. Fleischer's Laboratories, Medford, Mass.

HELP WANTED

PART Time, stamp-cactus catalogue 10c. Big mail 10c. Hobby list 10c. Robinson's, San Pablo, Calif.

BIG Money taking orders; shirts, ties, hosiery, underwear, pants, jackets, sweaters, uniforms, etc. Sales equipment free. Experience unnecessary. Nimrod, 4922-BG Lincoln, Chicago.

UNEMPLOYED? Addresses of 182 aircraft factories now hiring unskilled men, \$1.00. Box 11, Tracy, Minn.

FREE—Big list of helpful books. Popular Mechanics Press, 200 E. Ontario St., Chicago.

AGENTS WANTED

HOUSEHOLD And wagon salesmen! Shortage of standard drinks this summer means big profits in household beverage trade. Sell first really new home beverage drink in ten years. Delicious, sensational, different, new taste thrill, highly concentrated. Steady repeat profits. Send 25c for full size sample and complete details. General Fruit Products, Desk P. Point Pleasant, New Jersey.

AGENTS Make big profits. Complete household line. Rock bottom prices. Free wholesale catalog. Royce Products, 329PM South Wood Street, Chicago.

MONEY Making sensation. Sell birthday card assortments 30c up. Request famous all occasion \$1 box on approval. Hedenkamp, 343 Broadway, Dept. G-5, New York.

LOOK! I'll give you \$5.00 worth foods, groceries, etc., free. Exciting offer for every person who wants to make splendid money, full or spare time. Send no money. Send name and address for big free assortment. Zanol, 6281 Monmouth, Cincinnati, Ohio.

ENGRAVED Name plates, etc., a brand new line, large profits. Brett Bros., Winthrop, Mass.

NEW Patriotic seller. Send 15c for sample and prices. Vito Pastorella, 238 Mott St., New York, N. Y.

TIRES, "Autocop" stops thieves cold, protects whole car. Sample \$1.75. Autocop, B20030 Russell, Detroit.

WATERLESS Hand cleaner. Motorists and defense workers best customers. Full-sized package 35c. Remuvit Co., 1943 Barry, Chicago.

WRITE For free fabric samples amazing stainproof fabric cloths. Clean with damp cloth. Require no ironing. Beautiful patterns. Look expensive. Long wearing, low priced. Commissions big. Also complete dress line. Melville Company, Dept. 3202, Cincinnati, Ohio.

CHAMPION Belts, suspenders 75c, 3 \$2.00 postpaid cash with order. Manufacturer, 844 W. Baltimore, Baltimore, Md.

SELL Six 9x12 rugs a week and earn better than \$75.00. Wagner Rug Works, Seneca Falls, N. Y.

PLATE Glass name plates for doors. Agents wanted. Sample 50c. Harvey Richard, 70 Oliver, Southbridge, Mass.

FREE Water and our concentrates, make flavors, lotions, shampoos, 73 products, labels, bottles furnished. Quaiclo, E-20030 Russell, Detroit.

AGENTS—Salesmen, 200% profit. New 10c collar support every man needs. Sell stores and direct. Free merchandise offer. Hawkins Specialties, 537 So. Dearborn, Chicago.

KNIT For defense. Auto knitter machine makes pair military socks hourly. Also mufflers, caps, mittens. Demonstrate in department stores, relief agencies, knitting groups. Write for proposition. Ainslie Knitting Machine Co., 750 Grand St., Brooklyn, N. Y.

PROFITABLE, Dignified business for high grade industrious men and women retailing Rawleigh products direct from manufacturer to consumer. Every home your market. Large repeat orders. A few openings nearby. Write Rawleigh Co., Dept. E-65-PPM, Freeport, Ill.

BIG Profits selling Shelton Dust Absorbers. Samples 6—\$1.00 prepaid. Shelton Mfg. Company, Colorado Springs, Colorado.

SELL Watches. Send stamp for list of pocket and wrist watches. Elgin, Waltham, etc. \$1.69 up. Wineholt, Box 85, Woodbine, Penna.

AMERICAN Flag decals, four on a sheet 5x6". Big profits now! Wholesale prices to agents, sample 10c. D'Autremont Art Works, 109 S. St. Clair, Dayton, Ohio.

PASTEST Selling patriotic items in America. New! Different! Samples (6 items) plus selling plan that works like magic. 50c. Kelly Company, 1428 Willow Avenue, Hoboken, N. J.

THIS Man's idea is a God-send to folks who need money. Laugh at "War-Pig," 25c complete. You make 1000% profit. Money back without question if not entirely satisfied. Send quarter to Ontario Enterprises, Inc., U. S. Post Office Box 575, Desk A25, Rochester, New York.

BEAUTIFUL V victory buttons on patriotic cards. Dollar bill brings 24. Retail \$2.40. Victory Button, St. Paul, Minn.

GREETING Cards, specialties, Hildebrand's 4554 North Uber Street, Philadelphia, Pennsylvania.

MAKE Extra money easily, selling ten different greeting card assortments. Freeman, 35 High, New Haven, Conn.

EARN \$10-\$15 Daily applying beautiful, goldlike sign letters. Cost 1c. Sell for 25c. Free samples. Hurry! Modernistic, B-3000 Lincoln Ave., Chicago.

DEALERS—Jobbers—70% off list. Auto polish-wax, nationally known. Lithographed cans. Consolidated, 1943 North California, Chicago.

AGENTS—Silk and Nylon hosiery. Big stock; complete line; all sizes. Selling like wild. Whirlwind profit opportunity. Replacement guaranteed. Your own hose free with large outfit. Rush hose size, name today. Wilknit, Desk CE-37, Greenfield, Ohio.

AGENTS, Big line including food products. Fast selling premium and bargain deals. Low prices. Send card for big outfit offer with gift. Ho-Ro-Co, 2715 Dodier, St. Louis, Mo.

BIG Money taking orders; shirts, ties, hosiery, underwear, pants, jackets, sweaters, uniforms, etc. Sales equipment free. Experience unnecessary. Nimrod, 4922-AN Lincoln, Chicago.

COMIC Clever everyday greeting cards. Straley, 1015 Mulberry, Springfield, Ohio.

SPECTACULAR Demonstrator. Make-sell sensational new cleaner. Details. O-Belfort, Engineering Building, Chicago.

SELL Individualized belts, buckles. Over thousand emblems to choose. Fast money maker. Repeat business. Write today special outfit offer. Hook-Fast Specialties, Box 1425, Providence, Rhode Island.

AGENTS—To mail our literature. Good profits. Home business. Maywood, 1133 Broadway, New York.

AGENTS: Stamping names on pocket-key protectors. Sample check with your name, address, 25c. Stamping outfits. Emblem checks, check-fobs, name plates. Hart Mfg. Co., 303 Degraw St., Brooklyn, N. Y.

AGENTS—300% Profit selling gold leaf letters; stores and offices. Free samples. Metallic Letter Co., 438-B North Clark, Chicago.

AMBITIOUS School seniors—Sell classmates the "tops" in graduation name cards. Best commissions. Free cards. Agencies going like wildfire. Hurry! Craftcards, Box 235-L, Pittsburgh, Penna.

AMAZING Cleaner! Makes cleaning easy. Premium deals gets orders. Free sample. Zimco, 5007 Irving Park, Chicago.

WINDOW Sign letters. New "Roman" style. Large sizes, penny each. Absolutely beautiful. Free samples. New catalogue. Atlas, 7941 Halsted, Chicago.

GAS Stations want this new patented necessity. Knipp, Long Beach, California.

GOOD Paying business silvering mirrors, plating autoparts, reflectors, bicycles, bathroom fixtures by late method. Free particulars and proofs. Gunmetal Co., Ave. N. Decatur, Ill.

BIG Money applying initials on automobiles. Easiest thing today. Free samples. If you sell printing and advertising specialties we have an excellent sideline featuring Decalcomania name plates in small quantities. "Ralco," 727 Atlantic Ave., Boston, Mass.

DO You want agents for your proposition? Your ad in this space will place your message before hundreds of men seeking fast-selling products. My folder "How to Secure Agents," is filled with proof. I'll gladly send you a copy free. P. W. Johnson, Manager Classified Advertising, Popular Mechanics Magazine, 200 E. Ontario St., Chicago.

NOW, That you have read all these offers, send quarter (none free) "How" and "What" to sell by mail; through agents; or direct. Rochester Publications, Commerce Building, Dept. 1B5, Rochester, N. Y.

HIGH-GRADE SALESMEN

IMMEDIATE Opening for five men with cars, in each of the grain and livestock states. Exceptional opportunity for men with a farm background. Not affected by priorities. Permanent position, chance for advancement. Earnings from \$10 to \$20 daily. Write Sales Manager, 1716 Locust, Des Moines, Iowa.

BIG Profit daily. Sell business or personal Christmas greetings and calendars now. Experience unnecessary. Outfit free. Crescent Card Co., 121 No. 7th, Minneapolis, Minn.

CASH Daily selling union label printing. Free cuts. Book matches. Manifold sales books. Willata Printing, 950 Folsom, San Francisco.

ADVERTISING Book matches—World's largest "direct selling" book match factory offers advance cash earnings calling on every type of business. Experience unnecessary; full, part time; low prices; high quality; quick deliveries; powerful patriotic display, repeats. Free kit, instructions. Match Corp. of America, 3433 West 48th Pl., Dept. E-5, Chicago.

DISTRICT Representatives—Permanent territory, a business of your own—by LaSalle Extension University, a correspondence institution. Thorough training, much national advertising, liberal commission. Requirements—good personality, ability to counsel with prospects, will to work, a car. John D. Morris, 4113 S. Michigan, Chicago.

MAN With car to establish retail store route. Openings almost every locality. Handle orders for nationally known manufacturer-jobber. Average 50% commission. Steady big pay opportunity. Sales experience unnecessary. World's Products Co., Dept. 105, Spencer, Ind.

CALENDARS, Fans, novelties—Beautiful complete lines all sizes, including jumbos, samples free. Start now, be first in field. Fleming Calendar Company, 6539 Cottage Grove, Chicago.

BIG Commissions—selling to stores celluloid pricing tickets, metal shelf moulding. To restaurants, menu covers, signs. P. Pricing Press, 124 White St., New York.

WARTIME Makes our essential business necessities sell fast. Not affected by priorities. Large commissions advanced daily. Experience unnecessary. Samples free. Northwestern, 621-P Jackson, Chicago.

SELL Everyday greeting cards! Liquidating 3,000,000. Profitable sellers! Bulletin free! Sample box 25c. Elfco, 438 North Wells, Chicago.

SELL Business cards, stationery, book matches, gummed tape, restaurant necessities, salesbooks, advertising specialties, pencils, picture cards, tags, pricing sets. Lowest prices. 40% commission. Experience unnecessary. Free deals. Sales portfolio free. Willens, 2130 Gladys, Dept. 45, Chicago.

ADVERTISING Book matches. America's largest manufacturer of union label book matches. Fast selling line. Large sales producing kit. Sample matches. Complete cut catalog, 13 color combinations makes selling easy. Commission in advance. Superior Match Company, 7530 Greenwood, Dept. N-5, Chicago.

MAGIC Roach box. Attractive sales article. Sample 10c. Nock, 1712 Valmont, New Orleans, La.

UPHOLSTERY And rug cleaner sells easy—big repeater—quick, safe, economical. 50c package makes gallon liquid. Send dollar for three packages. Trial size full particulars free. Rite-Away Products, 310 West Burlington, Milwaukee, Wisconsin.

EXCELLENT Sideline. 100% profit selling tested collection plans to merchants, professional men. Sample \$1.00. Quantity discounts. Southern Associates, Waynesboro, Ga.

VICTORY-V-EMBLEM — Sensational! Fluorescent V display. Sells on sight. Big commissions paid daily. Write Victory, 82X West Washington, Chicago.

TIRE Locks. Big demand. Unlimited earnings selling garages, gas stations, stores, auto owners. Pullman Tire Lock Co., Room 200, 612 N. Michigan, Chicago.

NEW Specialty—Sells every business and professional man. Four \$15 sales daily pay \$270 weekly. Farrell cleared over \$1,000.00 monthly. Write, F. E. Armstrong, President, Dept. PM, Mobile, Ala.

BLADES—Big profits. Best quality. Factory prices. Ace Blades, Buffalo, N. Y.

EARN Money in your spare time taking subscriptions to Popular Mechanics. Unlimited possibilities, every family a prospect. Easy to sell. Bonus paid in addition to liberal commission. Send postcard for further details today. Circulation Dept., Popular Mechanics Magazine, 200 E. Ontario St., Chicago.

EDUCATIONAL AND INSTRUCTION

WELDING—Electric arc. Learn profitable trade quickly through actual practice. Individual welder instruction at bare cost of materials. Full particulars free. Valuable welding lessons book 50c. Hobart Welding School, Box M-522, Troy, Ohio.

NEW Writers needed! Free test shows your ability. It's fun. No obligation. Rush postcard to Comfort Writer's Service, Dept. 786-P, St. Louis, Mo.

"UNCLE Sam" jobs. War greatly increasing appointments, \$24.23 to \$40.38 week. Men-women. Prepare immediately for examinations. Full particulars—list positions, free. Write today, Franklin Institute, Dept. K2, Rochester, N. Y.

WELDING Opens the way to good pay and future in important industries. Growing need for trained welders. Prepare now. Practical, personal training spare time at home and Chicago. Write for free facts. Utilities Engineering Institute, 1314 Belden, Dept. 125, Chicago.

ART Studies—Magazines, courses, books. Catalog 10c. Cicerone's, 863(F) First Avenue, New York City.

"V"! Succeed with Super-Memory! "DK"—Info Company, Box 1122, Chicago.

TOOL Designing pays big. Home study course. Low cost. Easy terms. Free booklet. Ohio Institute of Technology, Box 56, Greenville, Ohio.

HOW To get a job! Information free. Guidance Service, Box 175, Crosby, North Dakota.

MEN. Try next railway mail clerk exam. Regulars start \$1900 yearly. Complete training, only \$9.75. Write, Oxment Instruction Service, 101, St. Louis, Mo.

CLINICAL Laboratory technic taught in your own home. Practice outfit supplied. Bulletin free. Imperial Technical Institute, Box 973-E, Austin, Texas.

LEARN Telegraphy! Splendid opportunities now prevail. All expenses low. Catalog free. Dodge Institute, Dept. M. Valparaiso, Indiana.

RADIO Engineering, broadcasting, aviation and police radio, servicing, marine and Morse telegraphy taught thoroughly. All expenses low. Catalog free. Dodge Institute, Dept. R, Valparaiso, Ind.

SECRET Investigation. Experience unnecessary. Detective particulars free. George Wagner, M-2640 Broadway, N. Y.

LOCKSMITH Course. Lock picking, key fitting, etc. \$1.00 prepaid. Locksmith, Canadian, Texas.

BECOME A Doctor of Psychology (Ps. D.) Teach secret of contentment, happiness. Solve mental worries. Free book. College of Universal Truth, 20-B East Jackson, Chicago.

ARC And spot welders. Make them yourself. Very simple. Inexpensive. Complete details 10c. Popular Mechanics Press, Dept. 394, 200 E. Ontario, Chicago.

CARTOONING, COMMERCIAL ART. SHOWCARD WRITING, SIGN PAINTING

LEARN Cartooning. Great demand; big pay. Course of instructions, pencil, how to sell your cartoons, \$2. Send today, Hollyart Studio, Box 1125, Hollywood, Calif.

CARTOONS Pay! Learn by mail. Personalized, inexpensive lessons. Warren, Artist, N7509 Smith, Spokane, Wash.

PEN And ink drawings. Let us draw your advertising and catalogue illustrations, from photos, copies or objects. Best work and fair prices. Heraldic Studios, 1914P Oakdale Avenue, Chicago, Ill.

CARTOONING Course—30 illustrated lessons, over 500 sketches, drawing paper, pens and pencils, complete, \$1.00 postpaid. Montes Studio, Box 985, Pasadena, Calif.

BECOME Cartoonists overnight! Have fun! Make money! Write, National Artists, 801-A North Marsalis, Dallas, Texas.

BUSINESS SERVICE

SAN FRANCISCO Re forwarding Service; prompt, bonded, obliging; \$1.00 month. 3402 Market St.

CHICAGO Mail address: \$1 monthly—Receiving, re forwarding your business, personal mail. General, 30 West Washington, (Established 1919).

ADVERTISING AGENCIES, LETTER WRITING, FOR ADVERTISERS

ADVERTISE Profitably: \$15 reaches 5,000,000 Sunday newspaper readers with 24-word ad. Newspaper, magazine, mailing-list ratebook, free. Chicago Advertising Agency, 20-PA West Jackson, Chicago.

ADVERTISE: 24 Words, 149 newspapers, \$6.50. Lists free. Advertising Bureau, 4515-C Cottage Grove, Chicago.

REACH Servicemen Veterans 1942 Directory 5c word. Loux, Box 774, Newark, New Jersey.

FREE—New Advertisers Rate Guide. 44 pages. Includes everything. Lowest rates. E. H. Brown Advertising Agency, Merchandise Mart, Chicago.

ADVERTISING Placed all magazines, newspapers U.S.A., Canada. Lowest rates. Free service. 84-page catalog free. Baker Advertising Agency, A-189 W. Madison, Chicago. Established 29 years.

TYPEWRITERS, DUPLICATORS, OFFICE DEVICES

"NEW Process" stencils for all duplicators \$2.30 quire of 24.5 quires \$9.50. Used office stencil duplicators, typewriters, \$15.00 up. Self-feeding post card stencil printer \$8.10. Write Pittsburgh Typewriter Supply, Department K-22, Pittsburgh, Penna.

TYPEWRITERS. Adder, mimeograph, multigraph, addressograph. Send for free lists of machines that will help you at half price. Pruitt, 28 Pruitt Bldg., Chicago.

RUBBER STAMPS AND OFFICE SUPPLIES

SUPERIOR. Natural rubber. Two lines 30c, three 40c, four 50c. Not synthetic rubber. Slocum, 814 Bradley, Peoria, Ill.

3 LINES 27c; Cushioned, indexed, 35c. Signatures \$1.50. Stamprite, Wauwatosa, Wis.

2 LINES 25c, 3 Lines 35c. Stamp Works, Auburn, Nebr.

PRINTING OUTFITS AND SUPPLIES

PRINT Your own cards, stationery, circulars, advertising. Save money. Simple rules furnished. Print for others, nice profit. Junior outfit \$8.25, senior outfits \$17.38. Details free. Kelsey, Inc., T-11, Meriden, Conn.

INEXPENSIVE 6x9 Printing press. Details free. Novelty Shop, Downsville, La.

PRESSES. Type, supplies. List free. Catalog ten cents. Model Press Co., York, Penna.

PRINT At home. 10c will bring a complete catalog of presses, type and supplies. P. Peiffer & Company, 6 Columbia St., Newark, N. J.

BARGAINS — Presses, type, supplies. Send stamp. 159 Harvard, Cambridge, Mass.

USED Presses, type, supplies. Lists 3c. Turnbaugh Service, Loysville, Penna.

PRINTING, MULTIGRAPHING, MIMEOGRAPHING, GUMMED LABELS

BEAUTIFUL Personal or graduation cards, 100 paneled cards, 25c. Text, italic, Gothic type. Printercraft, 1423 E. Elm St., Scranton, Penna.

75 HAMMERMILL Letterheads and 75 Whitewove envelopes \$1.00 postpaid. Benneville, 907 West Roosevelt, Philadelphia.

5000 6x9 CIRCULARS, \$8.25; 5000 elegant envelope slips, \$3.75. All printing low prices. Samples. Goodprint, Harrisonburg, Va.

PERSONAL Postcards save postage. 250—\$1.50. Cusack's Printery, Fulton, N. Y.

MIMEOGRAPHING—Samples for stamp, 250 copies \$1 up. Paramount, 1668 South Carolina, Atlantic City, N. J.

1000 LETTERHEADS, Circulars, etc., \$1.95. Samples? Thriftprint, Box 318, Chicago.

BUSINESS, Personal stationery, \$1.00 packets. Samples. Economy Press, LaCrosse, Wis.

GOOD Printing reasonably priced. Let us know your requirements for our low estimates. Write today. Birchwood Printers, East Paterson, N. J.

ENVELOPES: All sizes. Jack's Printing Service, Box 5450, Metropolitan Station, Los Angeles, California.

100 LETTERHEADS, 100 6 3/4 Envelopes, \$1.00. Lonnie Harmon, Sugar Grove, N. C.

HI-QUALITY Mimeographing, new photographic illustrations. Low prices. Samples. Hansen, 4908 Ohio St., Chicago.

500 FOUR Line gummed stickers 25c. Specialty Sales, 3064 5th, Chicago.

COMMERCIAL, Club, society printing—Reasonably priced. State requirements. Varak Printing, 2430 South Albany, Chicago.

STRICTLY First quality printing. Send 10c for 32 page catalog. Woodruff's, 217-A6 Lewis, Duluth, Minn.

"NO Lineage Limit" Mimeographing—300 letters or 300 postcards \$1.00. Dollar Letter service, 180 West Washington, Chicago.

1000 6x9 CIRCULARS, Letterheads \$2.95. Samples. Low prices. Address, Chelsea, Oklahoma.

PRINTING. Mimeographing — Letterheads, envelopes, statements, 1000—\$3.25. Samples. Raymond P. Schwarting, South Anana, Iowa.

EVERYTHING Printed, wholesale prices. Free list. Midwestern Printing Co., Springfield, Missouri.

QUALITY Printing, mimeographing—unsurpassed. Low prices. Samples free. Fame Press, Lathrop, Calif.

500 3 1/2 x 2 1/4 FOUR Line gummed stickers, 25c. Moritz Printery, Saginaw, Mich.

JOB Printing. Quick, reasonable. Samples. Atlantic, Box 653-H, Rock Hill, S. C.

WANTED Printing of all kinds by thousands of our readers. Your ad in this space will bring you some nice orders. Write for positive proof. F. W. Johnson, Classified Advertising Manager, Room 304, 200 East Ontario Street, Chicago.

PATENT ATTORNEYS

INVENTORS: Take first step toward protecting your invention—without obligation. Write for free "Record of Invention" form for establishing date of invention and free "Patent Guide for the Inventor"—telling about confidential search service; how to sell and market inventions; details of convenient payment plan. Send today for free "Patent Guide" and "Record of Invention" form. Clarence A. O'Brien and Harvey Jacobson, Registered Patent Attorneys, 21B-E, Adams Building, Washington, D. C.

INVENTORS: Write immediately for two free books, "Patent Protection" and "Selling an Invention." Explain many interesting points to inventors. "Evidence of Invention" form enclosed. Reasonable fees, forty-four years' experience. Avoid risk of delay. Address: Victor J. Evans & Co., Registered Patent Attorneys, 631-E Victor Building, Washington, D. C.

PATENTS Procured; easy terms; helpful service. Sanders, 6430 Evans, Chicago.

"INVENTOR'S Guide." 100 mechanical movements, free; advises on patenting, selling inventions. Frank W. Ledermann, 154 Nassau Street, New York.

PATENTS. Protect your idea by securing free "Proof of Invention" folder. Exceptional personal service. Established 1906. E. E. Vrooman, 871 Woodard Bldg., Washington, D. C.

INVENTORS—Patent your invention. Secure book, "Protect, Finance and Sell Your Invention." No obligation. McMorro and Berman, Registered Patent Attorneys, 134-C Barrister Building, Washington, D. C.

THIS Small ad means low cost in obtaining your patent. Free particulars airmailed. Robert Beck, Patent Lawyer, 850 Lafayette Street, Bridgeport, Conn.

WESTERN Inventors, save time; employ C. L. Drew, Atty. Registered in U. S. Patent Office, Central Tower, San Francisco, Calif. 32 years practice.

L. F. RANDOLPH, 302-B Victor Bldg., Washington, D. C. Low cost. Book and information free.

PATENTS. Booklet free. Highest references. Best results. Promptness assured. Watson E. Coleman, Patent Lawyer, 724 Ninth St., Washington, D. C.

INVENTORS—Before disclosing your invention to anyone send for form "Evidence of Conception"; "Schedule of Government and Attorneys' Fees" and instructions. Sent free. Lancaster, Allwine & Rommel, 411 Bowen Building, Washington, D. C.

FOR INVENTORS

115 MECH. Movements—Just what you may need to complete your invention. 48-page illustrated book contains valuable information for inventors. Yours—free. Write today. Victor J. Evans & Co., 632-E Victor Building, Washington, D. C.

WILL Consider purchasing, outright or royalty, patented or unpatented inventions, any line that meets our particular requirements. Prefer devices not too complicated, submit drawings or descriptions. No models. Joseph Reese, 30 W. Washington St., Chicago, Ill.

SAVE Money, time, worry, before you patent! Market invention quickly! System only \$1.00. Inventors Guide, LaCrosse, Wis.

EXHIBIT Your inventions 40 days; contact manufacturers; protect your ideas; technical advice; membership \$3.00 yearly. Inventors Club of New York, 600 West 125th Street, New York, N. Y. (Send stamp for reply.)

FREE Booklet "Why Invent?" shows sure way to success. Facts, no fake! Don't attempt selling or patenting your invention before you have read it! Invention-Service Company, Dept. A, Professional Arts Building, Hagerstown, Md.

INVENTORS—Have you a useful, non-military invention for sale? Practical new ideas, patented or unpatented, urgently needed by manufacturers and consumers. Write for details. Chartered Institute of American Inventors, Dept. 4-A, Washington, D. C.

I SELL Patents. Established in 1900. Charles A. Scott, 773PM Garson Ave., Rochester, N. Y.

CASH For practical ideas and inventions. Mr. Ball, AB-9441 Pleasant, Chicago.

SELL Your patent through a small classified ad in Popular Mechanics. Many inventors have found buyers in this way. Ask me for proof—I'll gladly send it to you. P. W. Johnson, Manager Classified Advertising, 200 E. Ontario St., Chicago.

INVENTIONS WANTED

CASH For practical article or idea. Mr., 3317 South 18th, St. Louis, Mo.

INVENTORS—Small manufacturers need new inventions for altered civilian markets. If you have a practical, useful idea for sale, write Chartered Institute of American Inventors, Dept. 4-D, Washington, D. C.

WANTED—Defense inventions, cash, royalty. Promptness important. Reporter, 9D-11236 So. Fairfield, Chicago.

CASH For inventions, patented, unpatented. Mr. Ball, A-9441 Pleasant, Chicago.

MANUFACTURING

MODELS—Small lot manufacturing. Metals, plastics, etc. Milburn, Burlington, Kentucky.

PATENTS FOR SALE

NEW Combination article for men. Leather-cloth. Simple construction. Excellent gift item. Patent 2,176,791. Cash-royalty. W. R. Cronan, 2236 Wilmington Court, Topeka, Kansas.

TO Sell or trade patented fastening device. BX 1523, Fargo, N. D.

MODELS AND MODEL SUPPLIES

SHIP Model kits and fittings. Complete line Fisher model yacht equipment. All Boucher, Fisher, Marine Model and Ideal kits, fittings and blueprints at catalog prices. Most complete stock in New England. James Bliss & Co., Inc., 220 State Street, Boston, Massachusetts.

TRAINS—"O" catalog 25c. "HO" 15c. Walters, 247 Erie, Milwaukee.

NEW Model airplane motors \$3.35 each. Particulars stamp. Ace, 1017-PM North McBride, Syracuse, New York.

MFG. Dies, stampings and model supplies. Send 3c for catalog. Pierce Model Works, Tinley Park, Ill.

TINPLATE Wide gauge, four trains; third rail, ballast, all extras. Cars properly marked. Gilman, 59 Seeley Ave., Arlington, N. J.

COMPLETE Ship and coach models kits with shaped hulls, parts and fittings—\$1.00 to \$6.00, 3c stamp for catalog. Miniature Ship Models, Perkasie, Penna.

LATEST Engine catalog 25c. Refunded. Howardco, A-2417 North Ashland, Chicago.

MODEL Railroaders, send 25c for copy of Model Railroad Magazine and 32-page booklet, "Your Model Railroad." Model Railroad, 1561 W. Pierce, Milwaukee, Wis.

MINIATURE Steam locomotives, new catalog listing all builders' needs 25c. Little Engines, Wilmington, California.

CARVED Hull ship model kits. Ship and yacht model fittings; model yacht sails. Illustrated catalog 20c. A. J. Fisher, 1002-M Etowah Ave., Royal Oak, Mich.

HOME CRAFTSMEN

NEW, Ready-mixed "blonde" wood finishes! Use on furniture, cabinets, plywood paneling, dril-wall construction, etc. Easy application. Good results every time. Special \$1.00 trial lot, sent postpaid. ½ pint Pen-chrome Dye Coat (choose one color: Platinum, blonde, bleached mahogany, driftwood, honey) and ½ pint Pen-chrome Clear Finish (for use over Dye Coat). Enough for 50 square feet. Send \$1.00 today for trial offer or write for free literature. O'Brien Varnish Corp., South Bend, Indiana.

SQUAREKNOTTERS! Make belts, handbags, etc. Quality cord samples with catalog, free. Beginners book, catalog and samples 10c. Special! Regular \$1 book with 50c beginners outfit, all for \$1. P. C. Herwig Co., Dept. J-33, 121 Sands St., Brooklyn, N. Y.

15 FULL Size what-not patterns 25c coin. Albright Service, M-6901 Railroad Ave., Omaha, Nebr.

LEARN To polish gems. Free information. Smith's Agate Shop, 228 Alder Street, Portland, Oregon.

GET Free leathercraft instruction pamphlets, prices of leathers, tools, projects. Fascinating hobby. Make beautiful gifts. Leather samples 5c. Wilder & Company, 1938 Crosby, Dept. 5P, Chicago, Illinois.

NEW Pattern and supply catalog:—Plywood novelties, lawn ornaments, silhouettes, decal transfers including latest "patriotics" for autos, etc., letter and numeral patterns, handy hand tools, new power sander. Other lines. 500 articles finely illustrated. Write today. Wo-Met Shop, Ashburn, Georgia.

49 LAWN Ornament patterns, Dutch boy, Dutch girl, some 21" high 60c. 20 novelty patterns 30c. 20 silhouette patterns 30c. 89 patterns \$1.00. Modern Woodcraft, Saginaw, Michigan.

IDENTIFICATION Bracelet \$1.00. Thick Sterling Silver Tag advertised page 180.

KNOCKDOWN Kits—Walnut, plastic, carved, inlaid-furniture, lamps, novelties. Ship-models. Machinery. 40-page illustrated catalog, 10c. Woodcraft Service, Plainville, Minnesota.

MAKE Money building bird houses. Great demand. Illustrated instruction book 25c. Popular Mechanics, 200 East Ontario, Chicago.

KNOCKDOWN Cedar chest, lumber, veneers, illustrated catalog 10c. Giles Kendall Co., Decatur, Ala.

MAKE Beautiful Mexican plaques. 20 patterns, complete instructions 25c. Mexican Artcrafts, Eagle Pass, Texas.

LEATHERCRAFTSMEN: Send 10c for new handbook and catalogue of tools and supplies. E. A. Sweet Company, Inc., Leathercraft Division, A-57, 148 State Street, Binghamton, N. Y.

1000 TELUHOW Plans tell homeworkers about building 1000 projects. List 10c. C. King, E. Kingston, N. H.

WOODWORKERS—Dime brings you whatnot pattern and instructions for finishing furniture. Carter Brothers, Ferrum, Virginia.

28 LAWN Ornament patterns 25c. Other patterns; 15" -20" high; Dutch girl, Dutch boy, pirate, bull terrier, Mexican girl, Mexican boy, dwarf, penguin, flower girl, 10c each; 3 for 25c. 25 novelty patterns 30c. All 62 full size patterns \$1.00 postpaid. Strother, Box 383-DN, Bellington, W. Va.

WOODWORKING Power tools—Make them yourself. Lathe, scroll saw, saw table, drill press, portable sander, bandsaw, motorized plane. Complete details only 10c. Popular Mechanics Press, Dept. 393, 200 E. Ontario Street, Chicago.

WATCHES, OLD GOLD, JEWELRY, ETC.

AGATES, Ores, fossils, etc. Beautiful, assorted collection of 50 fine and unusual specimens, \$10, postpaid. Samples 50c each. Frank Greenlee, Rt No. 3, Box 223, Port-Orchard, Wash.

WANTED! Gold, silver, platinum, diamonds, mercury, etc. Ship. Simon's Jewelry, 353 Old Arcade, Cleveland, Ohio.

SEND 10c For polished specimen California jade with catalog request. Rare gems, fossils, minerals, gem cutting equipment, fluorescent lamps. Grieger, 405 Ninita Parkway, Pasadena, Calif.

OLD Gold wanted. Highest cash prices paid at once—plus free gift. Gold prices highest in history. Mail anything gold or platinum (regardless of condition) such as gold teeth, bridges, rings, eye-glass frames, watches, jewelry, diamonds, etc. Get back cash that will surprise you by return mail. You must be satisfied or articles gladly returned. Our reliability guaranteed. Free information. Consolidated-Ward Company Dept. H-1, Post Office Box 810, Chicago.

ELGIN, Waltham watches \$3.50. Make big money. Free watch and jewelry catalog. Plymouth Jewelry Co., 163-F Canal St., New York.

AGATES, Fossil woods, three pounds \$1.50 postpaid. Jay Ransom, Aberdeen, Wash.

OPALS—Collectors' parcels \$5.00. Lapidaries' parcels \$5.00. Catalogue free. Norman Seward, Melbourne, Australia.

GOLD \$35.00 Ounce. Mail old gold teeth, diamonds, jewelry, watches. Receive cash by return mail. Satisfaction guaranteed. Free information. Dr. Weisberg's Gold Refining Company, 1500-Q Hennepin, Minneapolis, Minn.

5000 REBUILT Watches! Free catalogue—Diamonds, jewelry, (3c postage). The New York Jobbers, 74 Bowery, Dept. M, New York, N. Y.

GEMS, Agates, minerals, jewelry. Six rough gemstones—emerald, sapphire, garnet, topaz, freopal, agate \$1.00 postpaid. Catalog. Hill Co., Route 7, Salem, Oregon.

WATCHMAKERS' Materials, tools, jewelry—bought, sold. Best prices for old gold, diamonds. Free catalog. Ben Segal Company, Box 150, Chicago.

HIGHEST Prices for old gold—Mail your teeth, watches, jewelry. 100% full cash value mailed day shipment received. Satisfaction guaranteed or articles cheerfully returned. Information free. Chicago Gold Smelting Company, 300-P Champlain Building, Chicago.

I WANT To send you proof of the wonderful pulling power of Popular Mechanics Magazine's classified pages. What's your proposition? Write me today. P. W. Johnson, Manager Classified Advertising, 200 E. Ontario St., Chicago, Ill.

TOBACCO, SMOKERS' SUPPLIES

GUARANTEED—Chewing, cigarette or smoking tobacco, five lbs. \$1.25, ten \$2.00, 50 cigars \$1.85. Pay postman. Box cigars free. Carlton Tobacco Co., Paducah, Ky.

WANTED—MISCELLANEOUS

MERCURY (Quicksilver). Tungsten, molybdenum, nickel, tin, high speed tool steel scrap, metallic residues and metals purchased in any quantity. Write for quotations. Metallurgical Products Co., 35th and Moore Streets, Philadelphia, Penna.

NEW Products wanted. Will consider developing now for postwar production—can be mechanical or consumers goods. Confidential, responsible, progressive machinery building and sales organization. Address P.O. Box No. 1086, Short Hills, New Jersey.

HIGHEST Prices for used cameras, binoculars, microscopes, drawing sets, tools, any optical or scientific instrument. Satisfaction guaranteed. Gordon's, 162-M Madison, Chicago.

CASH For anything. Justice Jewelry Jobbers, 190 North Wells, Chicago.

PERSONAL

FREE Valuable \$17.50 four piece jewel set, also other gifts. A rare opportunity. No selling. Write World Wide Service, 1452 Broadway, New York City.

TATTOOING Outfits. Write today. Zeis Studio, 728 Lesley, Rockford, Illinois.

YOUR Handwriting reveals much. Yours explained. 25c. Vee Grey, Holly Hill, Florida.

HEALTH. Youth, vigor. Buy vitamins direct. Save money. Postcard. Matoska Products, White Bear, Minn.

MEXICAN Legal matters. William Cocke, Reliable American Attorney, El Paso, Tex.

WIN Prize money; booklet—"Successful Contesting" shows how, 10c postpaid. Bulletin listing \$100,000.00 prizes included. World Publishers, 4515-B Cottage Grove, Chicago.

NASAL Ailments; send name and address for free booklet on Bullock's discovery. National Laboratories, Benj. Franklin Station, Washington, D. C.

AVIATION Books—Latest titles—Bargain catalog free. Popular Mechanics, 633 St. Clair, Chicago.

MISCELLANEOUS

FIREWORKS Wholesale. Boys buy direct at wholesale, write for circular. C. C. Groff, Box 84, Lancaster, Penna.

OUTDOOR Fireplace units. 7 models \$6.75 up. Pontiac Outdoor Stove, 15 Spokane Drive, Pontiac, Mich.

BIG Mail for you. Latest moneymaking offers, opportunities, catalogs, magazines. Name listed in directory 10c. Ideal Service, 126-M, Park Ridge, Ill.

ART Pretty girl pictures. Nifty new series. Complete set 18 pictures \$1.00. Sample package 25c. Each picture full postcard size 5 1/4 x 3 1/4. Harlem, Box 10, Station J, New York, Dept. A-19-M.

UNIVERSAL Transparent angle and ratio at glance protractors, 100% engineering mechanics do all \$1.50 postpaid. Refund guaranteed. Trigoscope Instrument Co., 614 5th Ave., Coraopolis, Penna.

ZIPPER-ENVELOPES At last! Big profits, stamp please. Bankewitz, 114 Virginia Ave., Hempstead, N. Y.

IDENTIFICATION Bracelet \$1.00. Thick Sterling Silver Tag advertised page 180.

REFINE Crankcase drainings without cost! Convert into heater fuel. Save plenty! Particulars, Bx 102, Austin, Tex.

INFORMATION For treasure seekers. Write. Wyss, 104 1/2 Francis, St. Joseph, Mo.

START Profitable tattooing business. free instructions. Write Tatuco, 651 South State, Chicago.

TATTOOING Outfits, supplies, 1942 lists free. Percy Waters, Anniston, Ala.

COMIC Bowling league membership certificate. Every bowler buys. Sample 10c. Kant, 323-P Third, Pittsburgh, Penna.

WE Train you to become medical laboratory technician at home in spare time. Free catalogue. Imperial Technical Institute, Box 973-J, Austin, Texas.

GET A better job. Our books will help you advance. Bargain catalog free. Popular Mechanics, 633 St. Clair, Chicago.

RECEIVE Gigantic mails, magazines, samples. Your name in numerous mailing lists 10c. Howard, 396 Broadway, New York.

SEND 10c Stamps, for illustrated catalog on hard-to-find merchandise. All items selected by experts for utility, value and profits. Goldshield Products, Dept. FM, 350 Greenwich St., New York.

STEREOSCOPIC (Three dimensional) art photos. Particulars for stamp. Oddity House, St. Petersburg, Fla.

COATS Of arms and crests, correctly painted in colors or black and white, from heraldic description or furnished copy. \$10.00 and up. Highest grade work. Heraldic Studios, 1914P Oakdale Avenue, Chicago, Ill.

ELECTRICAL TECHNICIANS—Urgently Needed!

BLISS

In industry—in Army and Navy—electrical technicians win better jobs and ratings. Bliss training combines theory and practice in classroom and laboratory. Students construct motors; install wiring, test generators, motors, transformers, electronic tubes; learn drafting.

Qualifies graduates to enter all branches of electrical work; aids advancement. Bliss graduates have excellent jobs as technicians, engineers; hold ratings and rank in Army, Navy, Dormitory; campus. 50th Year begins Sept. 30. Send for Vocational Chart and Catalog.

REGULAR COURSE COMPLETE IN ONE SCHOOL YEAR

ELECTRICAL SCHOOL

115 Takoma Ave., Washington, D.C.

PRACTICAL AUTO INFORMATION

Keeps Cars Rolling by Making Repairs and Adjustments Easy!

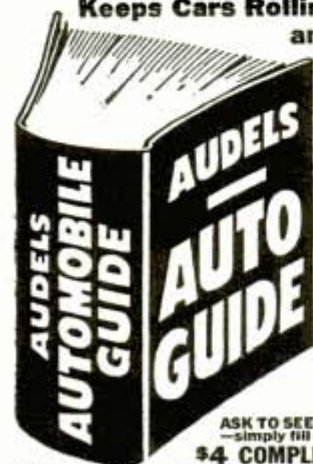

AUDELS AUTO GUIDE For Every Mechanic, Driver, Owner and Repair Shop.

Sent on 7 Days Approval Shows How to Tune Up—Keep Brakes Safe—Batteries Powerful—Tire Mileage Up—Save Gas—Lubricate Correctly.

ANSWERS YOUR QUESTIONS Contains all you need to know about 1—Construction, 2—Operation, 3—Service, 4—Repair of Modern Motor Cars, Trucks, Buses & Diesel Engines in every detail.

NEW FLUID DRIVE TREATED Easy to understand—1540 Pages, 1540 Illustrations. Gives definite directions on How to handle service jobs.

ASK TO SEE IT—Get this information for yourself—simply fill in and mail coupon today.

\$4 COMPLETE • PAY ONLY \$1 A MO.

AUDEL, Publishers, 49 West 23rd St., New York Mail AUDELS AUTOMOBILE GUIDE (\$4) for free examination. If O. K., I will send you \$1 in 7 days; then remit \$1 monthly until \$4 is paid. Otherwise, I will return book promptly.

Name _____
 Address _____
 Occupation _____
 Reference _____ F.M.



Powerful Vision—8 Mile Range
BINOCULARS
 20 Days Free Trial \$4.75
 Postpaid or C.O.D.

Scientifically ground, powerful lens that give clear vision equal to 110 yds. at 1000 yds. distance! Adjustable for all distances and eye widths. Binoculars come with handsome case and straps. GUARANTEED. If not satisfied after 20 days free trial money refunded. American Binocular Co., 7759 S. Halsted, Dept. F-262, Chicago.

KINKADE GARDEN TRACTOR

and Power Lawnmower
 A Practical Power Plow and Cultivator for Gardeners, Suburbanites, Florists, Truckers, Nurserymen, Fruit Growers
Low Prices - Easy Terms
 American Farm Machine Co.
 1058 33rd Av. SE. Minneapolis, Minn.



How long since you made movies of your family?
 Load up your CINE-KODAK today

METAL AND WOOD WORKING MACHINE TOOLS

Send for new FREE catalog of complete line of Machines, Motors and Accessories
WALKER-TURNER CO., INC. 152 Berckman St., Plainfield, N. J.

WELDERS WANTED!

ELECTRIC ARC—OXY-ACETYLENE Skilled Welders earn \$8 to \$15 a day. The demand now greater than the supply. Learn this highly paid trade in 2 weeks by actual shop work. One of America's leading schools. Established 1902. 7 floors of shops. Endorsed by welding industry. Limited number of students. 2 weeks course in Electric Arc or Acetylene Welding, including room and board, only \$104. Write or wire for reservation. Ask for "Welding Facts." State age.
 GREER COLLEGE, Dept. 152, 2024 S. Wabash Ave., Chicago





TIRE PUNCTURED 27 TIMES..

LEAKS NO AIR

1001 Repairs In Home, Auto, Farm For Only

New plastinoid "putty"—**SO-LO**—fills cracks, holes in tires, shoes, boots—anything of rubber, leather or cloth. Spreads on like butter. Dries tough. Waterproof, flexible, non-skid. Won't come off—guaranteed! 25c package (25 repairs) shows many uses. At any 10c or hardware store.

1 EACH

So-Lo

MAKE MONEY IN A CHICKEN BUSINESS OF YOUR OWN



50 billion eggs in 1942! That's what the Federal Government is asking for. Think of it! Here's your opportunity to enjoy a real income from Poultry with a successful business of your own. Prepare now to have that little chicken farm you have always wanted and guarantee yourself a permanent income when the war is over. Harry M. Lamson, nationally known Poultry Expert, teaches you money-making secrets. Learn at home quickly, easily, at low cost. Start small way, spare time, grow from profits. Method endorsed by many college-leading Poultrymen. Write TODAY for free catalog "How to Raise Poultry for Profit." Tells how to get started in this fascinating work. No obligation.

National Poultry Institute, Inc.
Dept. 50-9 Adams Center, N. Y.

"Valuable Investment" says Herbert L. Whalley, New Paltz, N. Y. who recently finished the course wrote: "The N.P.I. course was a very valuable investment for my poultry business. I've cut feed costs, manage my flock more economically and have learned to market my products to greater advantage. The N.P.I. course is simple... practical... complete. Of equal value for the beginner and the more experienced poultry farmer."

LOOK! Baby Chicks

THOUSANDS WEEKLY ALL YEAR. Finest quality & Layers in 40 breeds. Hybrid Baby Fulleas and Cockerels, B. W. D. Tested. Ducklings, Goslings, Baby Turkeys, Guineaas. In business 30 years. Catalog free. ORDER NOW. Make BIG money raising NABOB QUALITY CHICKS.

NABOB HATCHERIES, BOX M, GAMBIER, OHIO

MONUMENTS

SEND FOR FREE CATALOG As low as **\$9.50**

Enduring, strikingly beautiful GRANIDUR Memorials direct, at prices you can afford. GUARANTEED. Investigate our memorials before you buy.

ECONOMY MONUMENT COMPANY, Dept. F, 537 South Dearborn Street Chicago, Illinois



Say you saw it in

POPULAR MECHANICS

FACTORY-TO-YOU 1942 MIDWEST RADIOS

At Bargain Prices!

16 Tubes 9 Bands

SAVE your present cabinet, by putting in one of our powerful, new radio chassis. Also, a complete line of radio and radio-phonograph console models to select from. Supply limited—don't delay—send for FREE full-color catalog NOW!

30 DAYS' TRIAL

THE MIDWEST RADIO CORPORATION
Dept. 15-N Cincinnati, Ohio

Today's Thinkers will become Tomorrow's Leaders

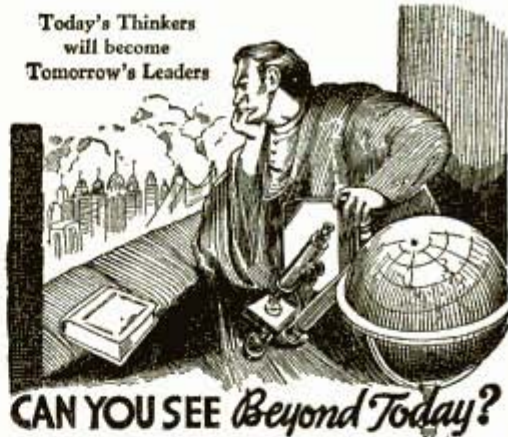

CAN YOU SEE Beyond Today?

TODAY is yesterday's tomorrow. Has it added anything to your life? Have you moved forward in thought as well as in time? Those who wait for today's events to give them the cue as to what to do, will find themselves lagging behind. The present is only a pedestal for progressive men and women to stand upon to see beyond, to look ahead to the great tomorrow. All about you are only the evidences of what has been done. They are now history—of the past. Can you visualize the tomorrow, next week or a year from now? If you cannot, you are a slave of the present, and marked for a life of uneventful monotonous routine.

This FREE book will give you a new view of Life

YOU CAN possess the imagination, the creative thought and far-reaching vision that has produced some of the world's most dynamic characters. Behind every new development, act of progress or success was a silent thought—a creative idea. Thousands today, in the privacy of their homes, unknown, unheralded are using secret principles for stimulating the creative, unused faculties of mind. From their thoughts will come the new industries, finance, business and civilization of tomorrow. SHARE THEIR SECRET of accomplishment by writing your request for this book to the Rosicrucians. Therein will be explained how you too may acquire these teachings which can mean so much to you in the new tomorrow. Address: Scribe Q. N. A.

The ROSICRUCIANS
[AMORC]

SAN JOSE CALIFORNIA
(The Rosicrucians are NOT a religious organization.)

LIKE TO DRAW?

ENJOY STEADY, CASH INCOME RIGHT FROM YOUR OWN HOME OR OFFICE WITH OUR NEW SERVICE OF COPYING AND DUPLICATING CARTOON WORK FOR ADVERTISERS.

POSTCARD BRING FULL PARTICULARS

3-M AD SERVICE, ARGYLE, WISCONSIN

BETTER PAY DEPENDS ON BETTER KNOWLEDGE OF YOUR JOB

Get This Big Catalog of Success Opportunity Books

Use Authoritative Self-Help books to train yourself for the big opportunities of today. Get higher pay through greater knowledge. See big 1942 Illustrated Catalog of simplified, self-help books on Aviation, Accounting, Engineering, Drafting, Radio, Machine Shop... also cultural and language books; English, Spanish, History, etc. Bargain prices on books of secretarial practice, typewriting, stenography and a hundred other useful subjects. Used or New... some as low as 40¢ postpaid. Money-back guarantee. Send 3¢ stamp for your copy of this big catalog.

SAVE 50% Wilcox & Follett Co.
1255 S. Wabash Ave., Chicago, Ill. Dept. P-5



ONCE it was your own business whether you buckled down and got the *training* that's essential to success.

Today it's Uncle Sam's business, too! Because this war will be won by *trained men* — trained men in uniform, and trained men in America's factories, shipyards, mines and mills.

For a few dollars monthly, you can start right now, in your spare time, studying an I. C. S. Course in your line of work. You'll be a one-man classroom — no one can hold you back. You'll get personalized, individual instruction to help you over the "rough spots." You'll study texts written by outstanding *practical* experts. In a few months' time, you'll notice a difference in your work (and so will your boss, probably!).

Don't put it off another day — another hour! Mark and mail this coupon for information on courses and costs.

INTERNATIONAL CORRESPONDENCE SCHOOLS

HELPING TO TRAIN AMERICANS FOR VICTORY



BOX 5635-J, SCRANTON, PENNA.

Without cost or obligation, please send me a copy of your booklet, "Who Wins and Why," and full particulars about the course *before* which I have marked X:

TECHNICAL AND INDUSTRIAL COURSES

- | | | | |
|--|--|---|--|
| <input type="checkbox"/> Air Brake | <input type="checkbox"/> Contracting and Building | <input type="checkbox"/> Marine Engines | <input type="checkbox"/> Sanitary Engineering |
| <input type="checkbox"/> Air Conditioning | <input type="checkbox"/> Cotton Manufacturing | <input type="checkbox"/> Mechanical Drafting | <input type="checkbox"/> Sheet Metal Work |
| <input type="checkbox"/> Airplane Drafting | <input type="checkbox"/> Diesel Engines | <input type="checkbox"/> Mechanical Engineering | <input type="checkbox"/> Ship Drafting |
| <input type="checkbox"/> Architectural Drafting | <input type="checkbox"/> Electrical Drafting | <input type="checkbox"/> Mine Foreman | <input type="checkbox"/> Shipfitting <input type="checkbox"/> Shop Practice |
| <input type="checkbox"/> Architecture | <input type="checkbox"/> Electrical Engineering | <input type="checkbox"/> Navigation | <input type="checkbox"/> Steam Electric <input type="checkbox"/> Steam Engines |
| <input type="checkbox"/> Auto Engine Tune-up | <input type="checkbox"/> Electric Lighting | <input type="checkbox"/> Patternmaking <input type="checkbox"/> Plumbing | <input type="checkbox"/> Steam Fitting |
| <input type="checkbox"/> Auto Technician | <input type="checkbox"/> Foundryman <input type="checkbox"/> Heating | <input type="checkbox"/> Practical Telephony | <input type="checkbox"/> Structural Drafting |
| <input type="checkbox"/> Aviation <input type="checkbox"/> Aviation Mechanic | <input type="checkbox"/> Heat Treatment of Metals | <input type="checkbox"/> Public Works Engineering | <input type="checkbox"/> Structural Engineering |
| <input type="checkbox"/> Boilermaking | <input type="checkbox"/> Highway Engineering | <input type="checkbox"/> Pulp and Paper Making | <input type="checkbox"/> Surveying and Mapping |
| <input type="checkbox"/> Bridge Engineering | <input type="checkbox"/> House Planning | <input type="checkbox"/> Radio, General | <input type="checkbox"/> Telegraph Engineering |
| <input type="checkbox"/> Chemistry | <input type="checkbox"/> Industrial Metallurgy | <input type="checkbox"/> Radio Operating | <input type="checkbox"/> Telephone Work |
| <input type="checkbox"/> Civil Engineering | <input type="checkbox"/> Locomotive Engineer | <input type="checkbox"/> Radio Servicing | <input type="checkbox"/> Textile Designing |
| <input type="checkbox"/> Coal Mining | <input type="checkbox"/> Machinist | <input type="checkbox"/> R. R. Section Foreman | <input type="checkbox"/> Toolmaking |
| <input type="checkbox"/> Concrete Engineering | <input type="checkbox"/> Management of Inventions | <input type="checkbox"/> R. R. Signalman <input type="checkbox"/> Refrigeration | <input type="checkbox"/> Welding |
| | | | <input type="checkbox"/> Woolen Manufacturing |

BUSINESS COURSES

- | | | | |
|--|--|--|---|
| <input type="checkbox"/> Accounting <input type="checkbox"/> Advertising | <input type="checkbox"/> College Preparatory | <input type="checkbox"/> First Year College | <input type="checkbox"/> Railway Postal Clerk |
| <input type="checkbox"/> Bookkeeping | <input type="checkbox"/> Commercial | <input type="checkbox"/> Foremanship <input type="checkbox"/> French | <input type="checkbox"/> Salesmanship |
| <input type="checkbox"/> Business Correspondence | <input type="checkbox"/> Commercial Illustrating | <input type="checkbox"/> Good English | <input type="checkbox"/> Secretarial <input type="checkbox"/> Spanish |
| <input type="checkbox"/> Business Management | <input type="checkbox"/> Cost Accounting | <input type="checkbox"/> High School | <input type="checkbox"/> Showcard and Sign Lettering |
| <input type="checkbox"/> Cartooning <input type="checkbox"/> Civil Service | <input type="checkbox"/> C. P. Accounting | <input type="checkbox"/> Managing Men at Work | <input type="checkbox"/> Traffic Management |

HOME ECONOMICS COURSES

- | | | |
|---|---|---|
| <input type="checkbox"/> Advanced Dressmaking | <input type="checkbox"/> Home Dressmaking | <input type="checkbox"/> Tea Room and Cafeteria |
| <input type="checkbox"/> Foods and Cookery | <input type="checkbox"/> Professional Dressmaking and Designing | <input type="checkbox"/> Management, Catering |

Name..... Age..... Address.....

City..... State..... Present Position.....

Canadian residents send coupon to International Correspondence Schools Canadian, Limited, Montreal, Canada
British residents send coupon to I. C. S., 71 Kingsway, London, W. C. 2, England

By Dr. A. A. Bates

Westinghouse Research Laboratories

IN SEARCHING for substitutes for the many materials now being poured into the funnel of our all-out effort against our enemies, American scientists are discovering many new things so good they probably will be preferred after the war to materials for which they are now pinch-hitting.

For instance, we might consider the "Cinderella" metal, molybdenum, new plastics that are taking over some of the jobs once performed by metals, and the revelation through research of new ways to improve such materials as steel, porcelain and metal platings.

At present the all-out search for substitutes seems like a mad scramble for things that will do in a pinch. For example, national defense and now war priorities have forced the substituter in some cases to turn to such rare metals as silver. But out of this scramble are bound to come lasting benefits to America, just as the emergency of 1914-1918 produced many of our most useful alloy steels and the light, strong alloys of aluminum.

Because America has almost a world monopoly on molybdenum, this

MAY, 1942

P 1415 Leggett

SUBSTITUTES WE'LL KEEP

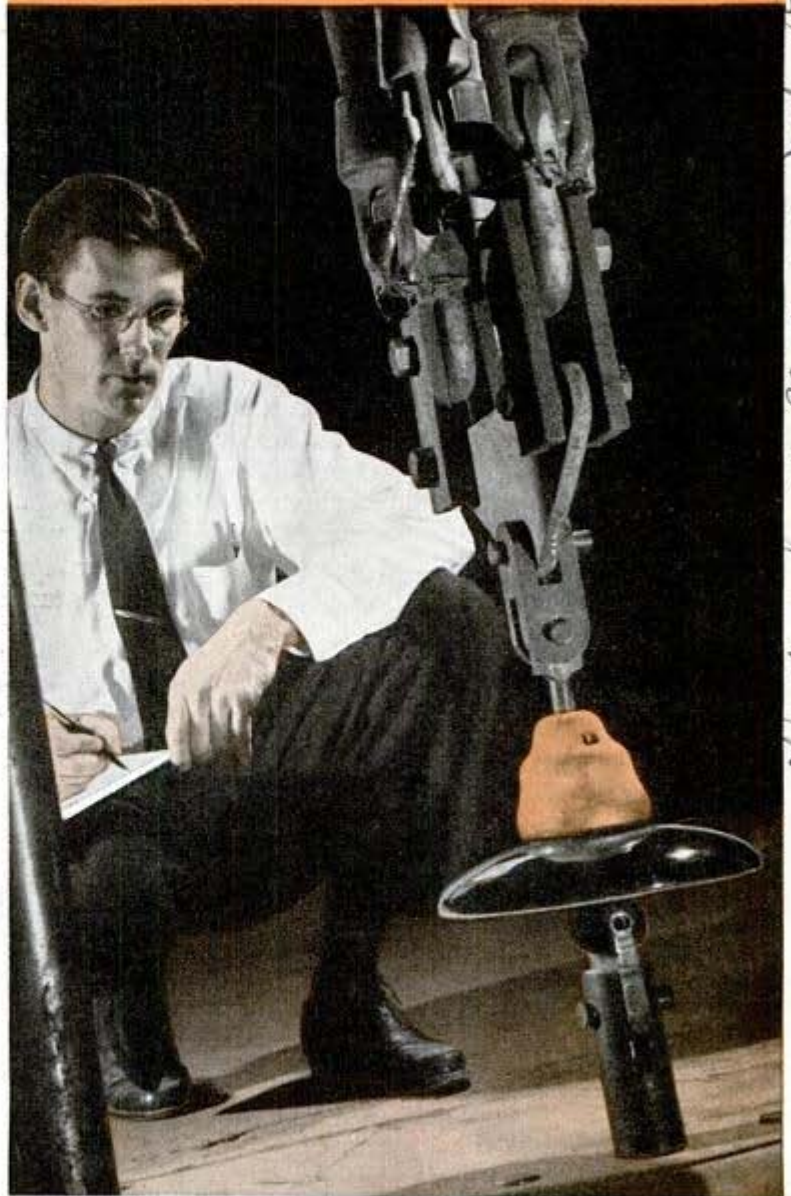

Porcelain insulator coated with new glazing material is shown here in "puller-apart" machine as Dr. Ralston Russell, Jr., records the results

Westinghouse Electric & Mfg Co, E. Pittsburgh, Pa

21415

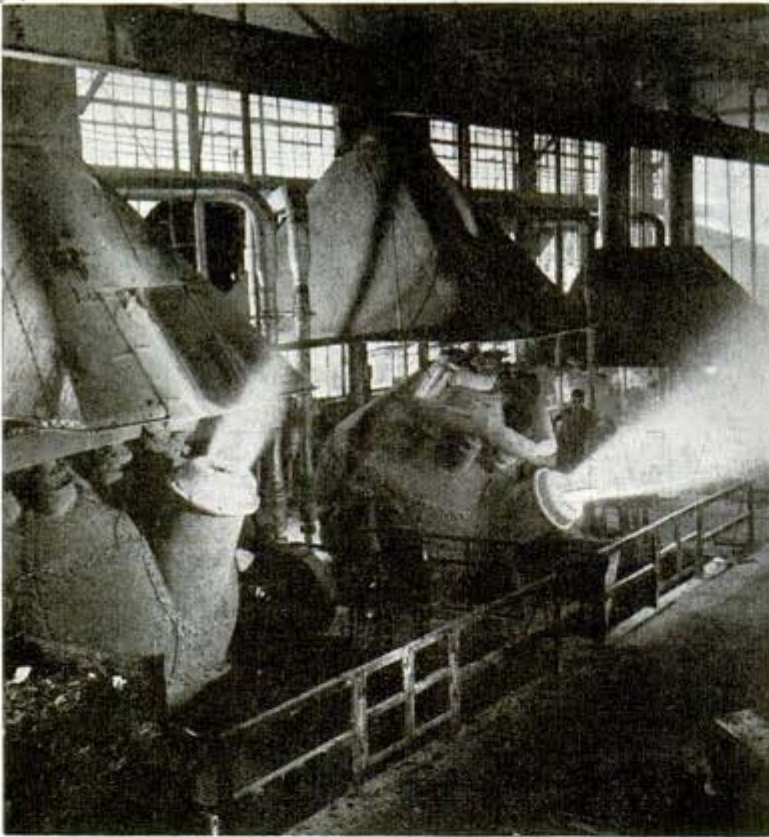

Metals reclaimed from Westinghouse machine-shop shavings, punchings and other leftovers are melted in gas-air furnaces to produce 20 tons of ingots per day; the "metal hash" is cooked at temperatures from 1,800 to 2,300 degrees Fahrenheit

al platings—we have always had to depend upon supplies from abroad. Partial or complete interruption of the flow of these supplies by our enemies seems certain.

Most of our tungsten comes from Burma and China, tin from Malaya and Bolivia, chromium from Turkey and Africa and manganese from Russia and India. The great stores of the world's nickel are in Canada and, although the war cannot easily interrupt our trade with that country, she is obligated to make her

metal seems destined to play a leading role in a new drama of steel making. This country is well blessed with resources of the base metals—iron, lead, zinc, aluminum and copper. But for nickel, chromium, manganese and tungsten—used as alloying elements added to iron to produce steel of strength, hardness or workability—and for tin—used in solder, bronze alloys and met-

supply available first to England.

As our supplies of these metals have dwindled with the spread of the war, they have been placed one by one on the priority lists by government authorities so that our defense and lease-lend programs—and now our all-out war effort—would not suffer from want of strong alloy steels for shells, tanks and guns.

Dr. Bates shows how plastic nose fits onto projectile for an antitank weapon



After ores have been purified to form pure tungstic oxide, the oxide powder is put into pans for drying in ovens



21415

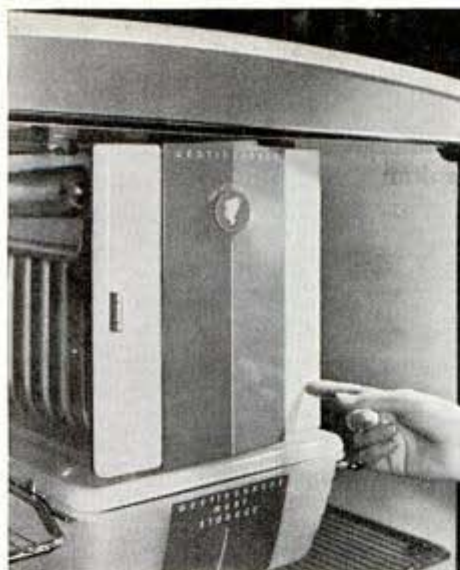

Refrigerator with evaporator door made of porcelain enameled steel with plastic facing

In an effort to maintain, as far as possible, the manufacture of its non-war products, metallurgists at Westinghouse have been searching for ways to utilize molybdenum instead of the priority-bound metals. Since the United States produces nearly 90 percent of the world's molybdenum, it does not seem likely that this country will ever suffer from a scarcity of this metal. The largest molybdenum mine is in Colorado and there are other deposits in Utah and Arizona. The metal is a newcomer to the production line, partly because our great stores of it were discovered in comparatively recent years and partly because of great difficulties which metallurgists experienced at first in learning how to produce and heat-treat alloys containing molybdenum.

At Westinghouse, and elsewhere, molybdenum is being employed in place of nickel, which has been used for many years as the strengthening element in steel for shafts, bolts, gears and other highly stressed parts of such machines as motors and generators. Because nickel steel is now in great demand for shells, the newer molybdenum steels are substituted where possible in making these tough parts of machinery.

Similarly, when tungsten was



Carrying a 20-pound insulator on head helps speed production

Molybdenum steel-tipped cutting tool shaving off layer of steel





Study of light-transmitting plastic bars may result in illumination of post-war homes with plastics connected to central light source

added to the list of strategic materials, a substitute was needed for high-speed tool steel, containing about 18 percent of this metal. The substitute was found and now various sections of Westinghouse plants are using tools made of molybdenum steel, containing only a small amount of tungsten. The new alloy is equal in quality to its predecessor and is less expensive—indicating that it may replace for all time the straight tungsten steel for many purposes where it was formerly considered indispensable.

Nickel and chromium, as well as tin and zinc, are among the favorite plating materials, which protect steel and other metals from rust, corrosion and tarnish. As these metals went on the priority list it became necessary to find substitutes. Then substitutes for substitutes had to be found.

Micarta bearings, made of plastics, ready to be shipped to steel mills where they will outwear previously used metal bearings many times



For example, the cover of one type of electric roaster was originally made of aluminum. First, plans were made to substitute stainless steel (containing chromium), but before these plans were put into effect, it appeared that stainless steel would become scarce and new plans were laid for the use of chromium plating over nickel plating. Then nickel and chromium priorities ended those plans. Now, as coverless roasters pile up in warehouses, engineers are working on an enameled steel cover.

In a few cases, engineers have resorted to the use of silver, one of the very few metals not affected by priorities regulations. A stainless steel part of a thermostat has been replaced by silver. Ordinary paint has partly replaced galvanizing (zinc coating).

Westinghouse has made many substitutions for aluminum. Nearly every bit of this metal has been removed from electric refrigerators. Ice-cube trays are now made of rubber. Glass and enameled iron have been substituted for aluminum in dishes, trays and other parts. Broiler pans and deep-well cookers on new ranges are made of enameled iron. Waffle-iron grids are made of cast iron. Plastics have taken the place of aluminum in washing-machine agitators, vacuum-cleaner nozzles and parts of other appliances.

(Continued to page 184)

m131 Conk. Warner Egden } Knoxville
 2519 Jefferson Ave } Tenn

Pneumatic Auger Aids Army Demolition Work

Clearing away bridges, small dams and roadways in the reservoir area of the new Cherokee dam in Tennessee gave army engineers an opportunity to test new demolition equipment. One of the implements was a pneumatic earth auger that quickly bores holes about a foot in diameter for placement of explosives. Working as under battle conditions, engineers set and shot some of their charges, completely demolishing in a matter of minutes many structures which might have been of strategic value to an advancing enemy.



Pneumatic auger speeds setting of dynamite charges by demolition squad

Tel. Columbus: 4669

K-M portable earth 3 1/6

Ca. Mo Tools Co. Chicago 5525 W. Chicago

Circulator Dries Air in Damp Rooms to Prevent Mildew

Capable of servicing up to 2,000 cubic feet of air space, an air circulator now available removes moisture from the air to prevent mold, mildew and condensation in damp rooms. Moisture is absorbed by carbon-containing chemicals furnished in small cubes. Ten pounds are sufficient to

absorb 10 to 15 pounds of water which drips into a container beneath. A built-in fan draws the air over the chemicals and redistributes it throughout the room. It also reduces the musty odor associated with mold and mildew. The unit measures 12 by 14 by 25 inches.



Chemicals in circulator remove moisture from air

MAY, 1942

The General Air Conditioning Corp. Cincinnati, Ohio

Gene Stone 2/13/42

Tin Cans Help Recover Copper From Mine Waters

Getting copper from old tin cans sounds like a miracle, but it really is a simple chemical process. The cans may be exchanged for an equal amount of copper by cutting them into small pieces and tossing them into mine waters containing copper sulfate. Iron sulfate is formed and flows away, while the copper, being precipitated on the metal pieces, is saved. Indicating that there has been a chemical exchange, and not a miraculous transmutation, the mine water loses its bluish color by the extraction of the copper and becomes yellowish from the addition of iron and tin. Cans will be available for this purpose even if they undergo detinning to recover the much needed tin, since the metal left after detinning is not regarded as good scrap because of the tin remaining in it.

m158
 Defense Plant Corp 5
 811 Vermont Ave.
 N. W. Washington

m114

Electric Blower Saves Time Drying Safety Equipment

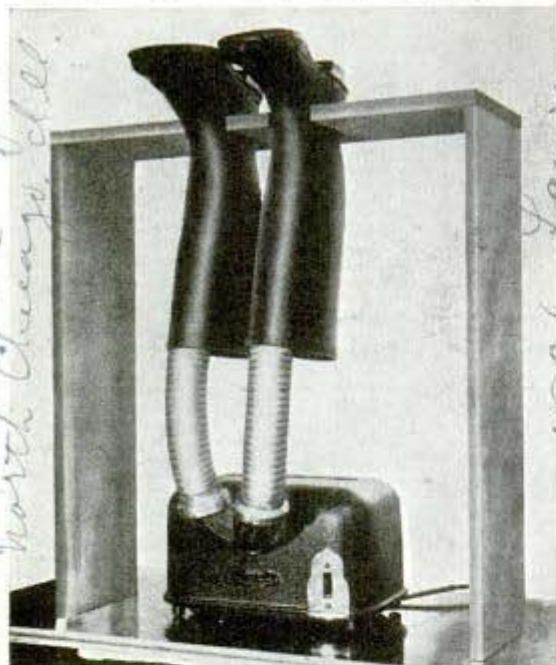

Heated air from blower drives moisture from boots

Drying safety equipment after it has been sterilized sometimes causes loss of time in industries where the same equipment is used by different persons. With a new type electric dryer it is now possible to dry equipment such as rubber boots, respirators, gas masks and goggles in three to five minutes. Operating on 110-volt current, the blower is equipped with a double hose connection that carries the heated air into every crevice of the equipment.

Homebuilt Body on Motorcycle Carries Two Passengers

To solve his dual problem of having economical transportation between his home and work, and being able to take his wife



Entrance to the body is gained through door in rear

Harley. Landsom Merri cycle

and youngster on occasional pleasure trips, E. Willard Fiske of Lockport, Ill., converted a three-wheel motorcycle into a passenger car. Removing the steel box at the rear, he replaced it with a body seating two people. The top was extended over the front, and with .040-inch Pyralin stock, such as is used on airplanes, a windshield was installed. In the door there is a window that may be raised and lowered, and between the driver and occupants are two glass panels that slide sidewise to open and close. When the car is to be used for hauling tools and equipment, the seat cushions may be removed. The springs required only the addition of one leaf. Carrying two passengers and driver, the car travels 65 miles per hour and makes 45 to 50 miles on a gallon of gasoline.

m-146

Home Baler for Newspapers Simplifies Tying Bundles

Made of heavy wire, a newspaper baler for home use includes a holder for a ball of twine and a cutter. Placed on the floor, a table or a shelf, or hung on the wall by strong rings at the top of the frame, it of-

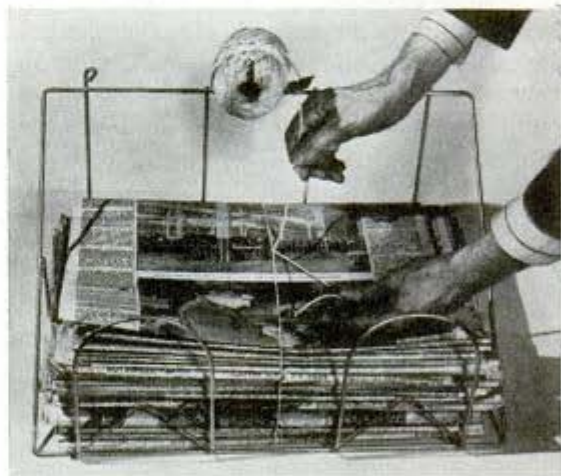

Newspapers can be tied without removal from rack

fers a convenient place for keeping old newspapers as they accumulate. When fully packed with papers the baler holds 25 pounds, which can be tied together quickly and the cord cut by drawing it against the cutter's edge. The cutter consists of folded metal, housing a replaceable razor blade with its edges guarded to prevent injury.

(To learn where to buy commercial products described in these pages, see the index.

*m 112 Capt. Walter E. Werwath
1027 W. Johnson St. Madison Wis*

Flashing Target Simulates Enemy Battle Line

Lights flashing at split-second intervals on a landscape target help to make marksmen of R. Q. T. C. cadets at the University of Wisconsin's 1,000-inch indoor rifle range. The arrangement of lights brings "blitzkrieg" atmosphere and the element of surprise to target practice, and trains both officers and men to fight confusion when attacked from all sides. The lower half of the target consists of a scene painted in color and studded with two round lights representing machine gun nests, and two long, thin lights that simulate ambushed infantrymen. The cadets aim at these, but the sights of their rifles are set so bullets hit 23 inches above, on the upper half of the target, which is a duplicate of the lower section printed in black and white. Scoring sheets placed over the locations corresponding to the lights on the lower part record the marksmanship of each squad. To prevent seeing where bullets are hitting, which cannot be seen in actual

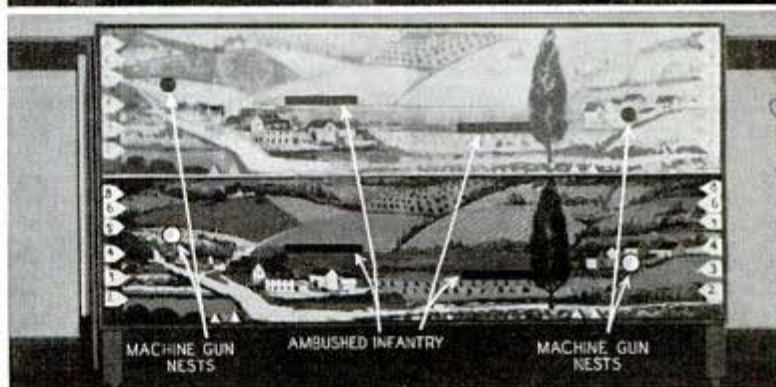
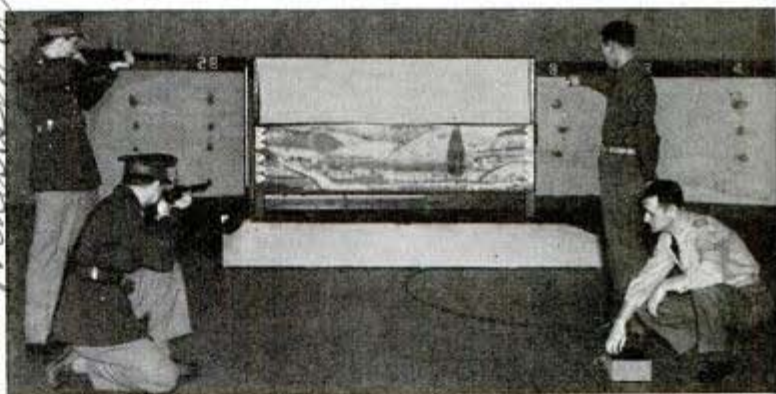

Top, squad firing at target while officer blinks lights; center, back of target with lights in place; bottom is target with curtain raised

battle, a canvas is drawn over the upper half until firing has ceased. Twelve men in a squad divide up the hedge, each covering his portion by shooting at three points within it. While firing continues, the officer at the controls may flash one of the

lights representing a machine gun nest, providing a test in fast thinking for the sergeant leading the squad, who must then assign enough of his men to cover this new point of attack to maintain his fire superiority. The rifles used are .22 caliber.

*New York Times
2/8/42*

m-147

Flexible Plastic Photoflash Bulb Is Filled With Oxygen

Flexible cellulose acetate substitutes for glass in a new photoflash bulb which produces a highly intense light and therefore can be made smaller than the conventional glass bulb. Accidental explosion of the bulb would be harmless since there is no glass to shatter, and the plastic material

withstands shocks so well that it needs no special packaging. The bulb is filled with the usual metal foil, and oxygen under pressure is injected to make the foil burn with great intensity. A patent on the bulb has been assigned to the Westinghouse Electric & Manufacturing Co.

MAY, 1942

Patented by Michael J. Neymanin de Madritta. New York

*Pat. # 2,272,059
E. Pellsburgh, Pa*

Developed by U.S. Army Sgt. W. V. Webb. Ray Harris

L1239

Leggett

"The MARINES have LANDED ---"



U. S. Marines and soldiers dashing ashore through the surf with guns ready in joint landing exercises

LANDING on a strongly defended enemy coast—perhaps the most difficult operation of modern warfare—is the task for which Uncle Sam's marines have been, and still are preparing.

Deepest secrecy necessarily shrouds the training and development of methods. Working with army and navy forces which would cooperate with them in a major landing effort, the marines have been developing methods as unusual as anything

uncovered by the European war. Their objective has been the creation of a formidable force with greater speed and mobility than any the world has ever seen—a force capable of striking from the sea and the air to seize and hold hostile beaches until supporting troops can arrive.

To reach land in safety in the face of enemy fire calls for equipment that will transport the marines and their weapons across open water at the utmost speed—

troop-carrying trucks that can swim and specially designed barges for carrying artillery and tanks to shore, and all constructed so that unloading is a matter of minutes, rather than hours. Other equipment must be available for dropping hundreds of heavily armed men by parachute and glider to seize open fields upon which troop-carrying planes may land.

One of the latest vehi-

Sea-going tanks are these and highly useful in landing operations



L1239



Philadelphia Inquirer photos

Marines, above, are advancing beside a light tank in maneuvers
Cargo nettings swung over the side of a ship enable U. S. Marines
to climb aboard or leave the vessel for landing boats

cles to join the marines is the Roebling tractor which travels on land and water with equal ease while loaded with fighting men. Tank lighters, on which one or more tanks can be transported, already are in use. Marine engines propel the lighters from ship to shore at high speed. Built so their bows can be thrust high on the beach, the lighters have ramps which can be lowered quickly for the tanks to unload under their own power and begin fighting. Thirteen-ton tanks may be carried by these lighters; not far in the future may be lighters for tanks twice as heavy.

Just how could a landing operation be carried out? Secret methods cannot be disclosed, but in general the operation might proceed in this manner:

An expeditionary force—a strong naval force, including aircraft carriers, accom-



L 1239



at new River, N.C.

Hauling artillery piece along beach in joint maneuvers of marines and soldiers

panying troopships—would approach the enemy coast. First would come bombardment of the beach and adjacent areas to drive enemy forces away from the territory to be occupied. Big guns of battleships and cruisers and bombing planes from the carriers would blast away, perhaps for hours. Then the transports would move closer and landing boats, amphibious tractors, tank lighters and artillery barges—probably preceded by swift "mosquito" boats—would sprint for the beach.

Specially trained troops, armed with grenades, machine guns, automatic rifles and other light equipment, would spring

Official U. S. Navy photo

from the landing boats and attack enemy machine-gun nests. Light tanks would lumber from their lighters to charge defense works, light artillery would be wheeled from the barges and put into action. Wave after wave of men would follow, as the landing craft continued to pour troops and equipment onto the beach. In the early stages of the operation, parachutists would drop from the skies to assemble into units of automatic riflemen and machine gunners for an attack on an airport or open space where gliders and planes carrying more heavily armed infantry and equipment might land. Here is where speed is vital—all forces must be whipped

Crocodile
Three Marine Corps boats hit the beach carrying tank and two military vehicles



Lake Pontchartrain La. New Orleans

POPULAR MECHANICS

Reconnaissance motor truck

13 1/2 ton tank

armored recon tank

21239

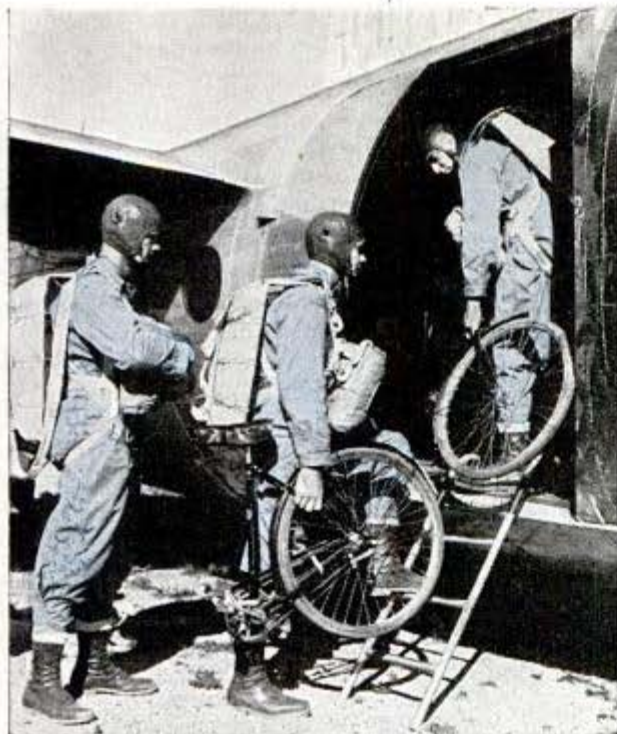

Marine Corps 'chutists boarding plane with folding bicycles in sections. In actual warfare separate 'chutes would be attached to cycles

Marine Corps 'chutist demonstrates how he would be prepared to ride off behind enemy lines on quickly assembled folding bicycle after landing

into an organization able to defend the airport against counterattack and this must be done without a lost moment. Then can come more planes with reinforcements and heavy guns and light tanks.

If the enemy could be pushed back far enough to make the beach-head fairly safe, engineers would construct sturdy docks on which still heavier equipment could be unloaded—a necessary operation because each man in the field requires several tons of equipment, including large-caliber guns and tanks. At this point the Marines might be said to have the situation well in hand.

The Marine Corps has been developing another new fighting organization, which also is composed of specialists. Known as the defense battalion, its job is to dig in and hold a specified area against numerically larger attacking forces. This unit is intended to be sent ashore to hold islands or ports vital to the American Navy. Batteries of long-range naval guns are part of the battalion's equipment for protection against enemy attacks from the sea and speed in mounting these guns is a part of the unit's training. Machine guns are employed against enemy infantry and anti-aircraft guns against air raiders.

Since speed and mobility are two necessary qualities in operations of Uncle Sam's

marines, the "triangular" organization is employed. Instead of the cumbersome division consisting of some 25,000 men just after the World War, the 1942 division is composed of about 15,000, including three infantry regiments and one organic artillery regiment. The smaller force is, of course, easier to handle, making for speed.

The Marine Corps has been training pilots, mechanics, gunners and parachutists as rapidly as facilities and equipment became available. The flying marine learns to handle land and sea planes and to take off and land from the tossing deck of an aircraft carrier and rocky landing fields perhaps carved from the jungle. But the most recent development has been the parachutist and the air-borne infantry. Work in this field, too, is secret, but it is known that the Marine Corps has been perfecting an organization to exploit the possibilities of principles established in the successful air attack on the island of Crete by German 'chutists and plane-transported soldiers. Candidates for 'chute units must be young men of specially robust physique and unusual activity; their course consists of jumps from platforms set a few feet high, then from towers arranged so that captive parachutes may lower them to the ground and finally from airplanes. Special

Westfield Columbia Company Westfield Mass

L1239



Above, Marine leaping from amphibious tractor in semblance of landing operation. Right, practice with bayonets at Marine Corps base

troops and shock troops for landing behind enemy positions.

Always maintained in a state of readiness, the Marine Corps today probably could put at least an entire division, with complete equipment, on an enemy coast faster than any other military organization in the world. Even in its early history, the Marines could embark a fully equipped battalion aboard ship on 24 hours' notice; today they can do it even faster—the result of constant training, planning and research.

equipment is carried by the 'chutists so that they may go into action the instant they touch the ground. In addition to a formidable array of weapons, the parachute troops may be expected to carry a supply of folding bicycles on which they would be able to reach an objective, or protective cover, more rapidly than they could on foot. Machine guns and other equipment which would be too heavy for the individual to carry are dropped by separate parachutes.

Marine Corps officers and enlisted men are being trained in preparation for immediate development of a glider division. It is understood the marines will use large gliders for supplying ground troops from the air and as transports for parachute



Age of Adirondack Mountains Is Over One Billion Years

Recent investigations by Dr. J. P. Marble at United States National Museum at Washington, D. C., have checked the age of the Adirondack mountains at approximately 1,100,000,000 years. This conforms with a previous finding in Vienna determined from the uranium-lead content of specimens of uraninite some three years ago. Dr. Marble's study was made with a mineral known as allanite, which contains thorium, a radioactive element. Like uranium, it degenerates into lead through radioactivity, but at a considerably differ-

ent rate. The fact that different materials having different decay rates were used in the two analytical tests, is regarded as convincing proof that both calculations are highly accurate. The calculated age represents the time that has elapsed since the rock materials which make up the mountains were brought together in their present position. Literally a "rock of ages," these mountains were formed, according to this evidence, long before anything remotely like life, as it is known today, existed on the earth.

National Research Council, Committee on Measurement of Geological Time

M 150

Chicago Fire Dept. Training School

Right Way to Fall Into a Net Taught Firemen

Auxiliary firemen being trained for civilian defense in Chicago must learn the rudiments of rescue work as well as fire fighting methods. One lesson teaches the correct way to fall into a fire net. The firemen learn that one who jumps to safety from a burning building should spread out the arms and legs in order to distribute the shock and avoid injury upon striking the net.



This "all-point landing" is recommended by instructor when falling into a fire net. Such a landing averts injuries which might result if arms or legs strike first

M-133

Chicago Fire Dept. Training School

Commonwealth Edison, American Region Post

Shingles Are Made Fire-Resistant With Chemical Coating



Fireproofing properties of a chemical developed for use on inflammable war materials were demonstrated recently on a specially built shingle roof. Only half of the roof was given the flameproofing treatment, after which the entire roof was sprayed with gasoline and ignited. The untreated side kept blazing long after the gasoline had burned away from the treated shingles.

Plastics Substitute for Tin In Collapsible Tubes

Your tubes of ointment and toothpaste and shaving cream soon will be made of plastics or metal alloys instead of the tin made precious by war in the orient. One manufacturer has developed a plastic tube which can be made from several synthetic materials, and is being tried as a container for such foods as catsup and peanut butter. Another is bringing out a pliable tube made of a secretly compounded metal alloy.

Flames still lick across untreated shingles long after gasoline has been burned from the fireproofed portion leaving it cool

MAY, 1942

Acme
Dr. O. J. Bodnefeld

New England Collapsible Tube Co. New London, Conn

Mr. O. J. Lein Chemical Products, 3051 Roslyn Ave, Los Angeles

Vertical Price Co. 6404 Sunset Blvd. Los Angeles

Vertical Price Co. 6404 Sunset Blvd. Los Angeles

m135

FLYING CARRIER



Cutaway view of flying carrier for bombing planes

Acme

Courtesy Goodyear Co.

Closeup of hook-on arrangement, which permits airship to launch and pick up planes, employed in extensive tests

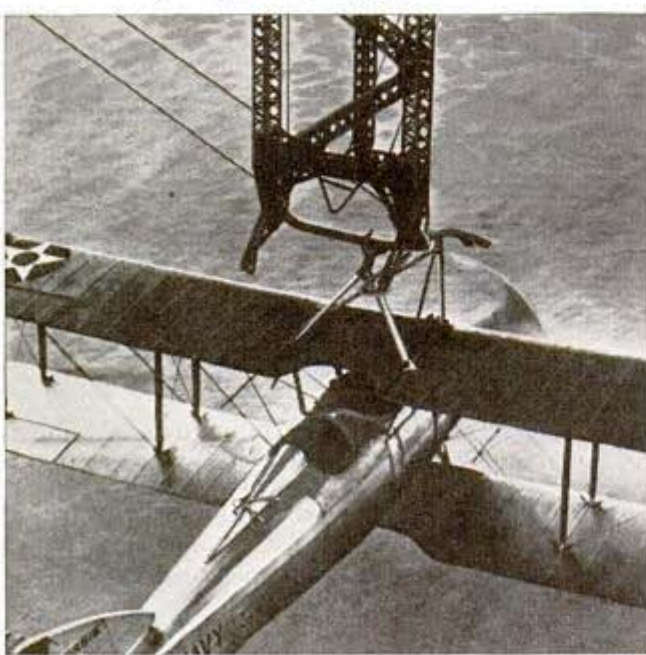

RIGID airships, each carrying ten attack bombing planes and capable of ranging thousands of miles from their bases, might be employed effectively by the United States Navy, according to lighter-than-aircraft experts. One type, designed by the Goodyear Tire and Rubber Company, pioneer builders, would have a capacity of 10,000,000 cubic feet of helium, the nonexplosive and nonburning gas of which America has the only large source of supply. It would have a top speed of 84 nautical miles per hour and a cruising speed of 50, more than twice the speed of surface aircraft carriers. This flying carrier would operate in conjunction with other units of the navy, including aircraft carriers. Immune, of course, to submarine attack, the airship would be expected to operate be-

for WARPLANES

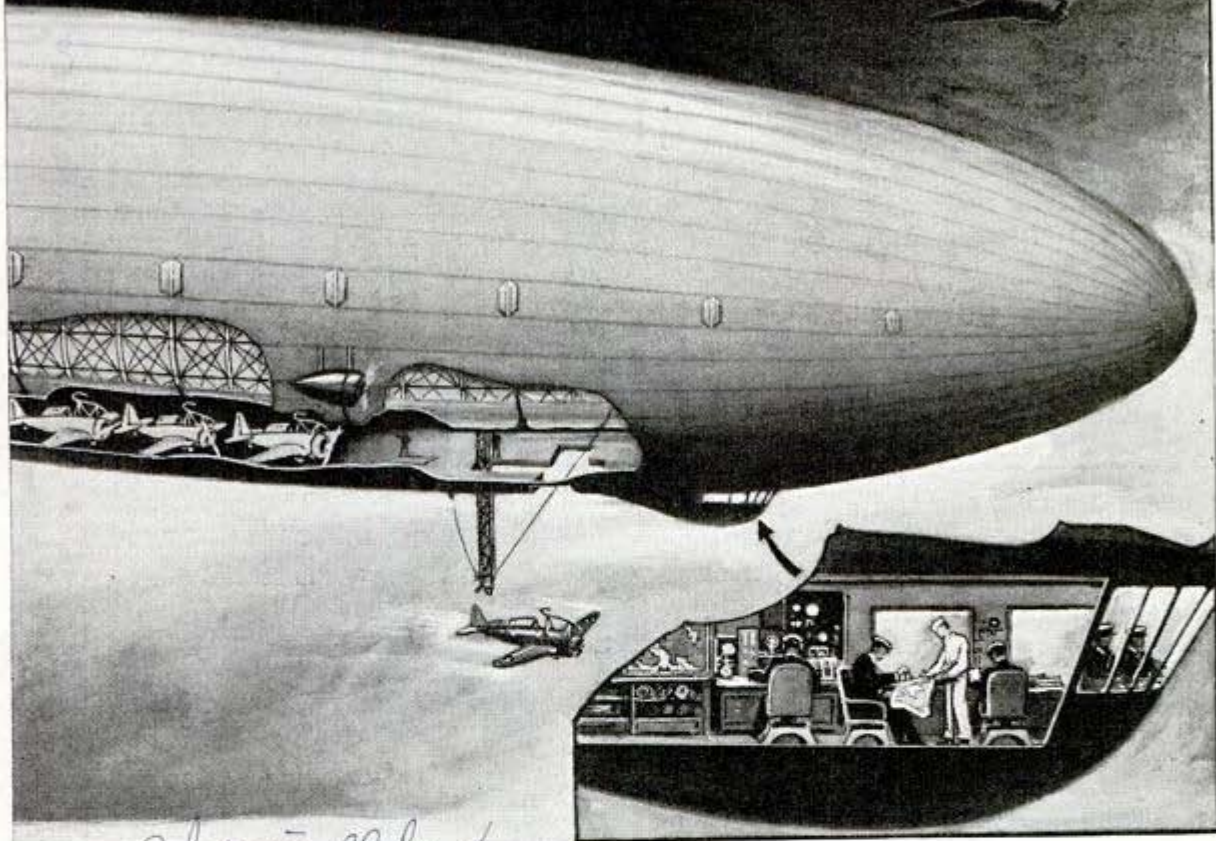

Akron 11/13

Control cabin as visualized by artist; arrow shows location

Plane just dropping away from the "trapeze bar." Above is trapdoor through which planes are lowered for launching

yond the range of land-based enemy planes and at altitudes above the effective gun range of surface vessels. In case of attack, it would be able to take refuge in the clouds while its own planes streamed out to meet the enemy. It is known that planes can be launched and retrieved by airships because more than 3,000 such operations were made with the airships Akron and Macon a few years back. Launching is accomplished by lowering the plane, attached to a sort of trapeze bar by means of a hook, through a trapdoor. Then, with the plane's motor or motors roaring the pilot releases the hook and the plane drops away. Upon its return to the "mother ship," the plane attaches itself to the trapeze bar by means of the hook as the two fly at virtually equal speeds. Then the plane is drawn into the airship.

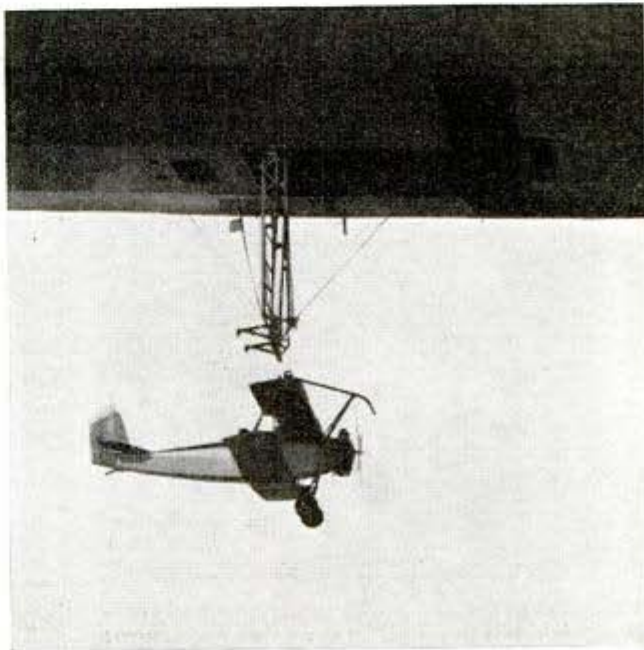

M 52

Fluorescent Lamp for Wall Adjusts to Any Height

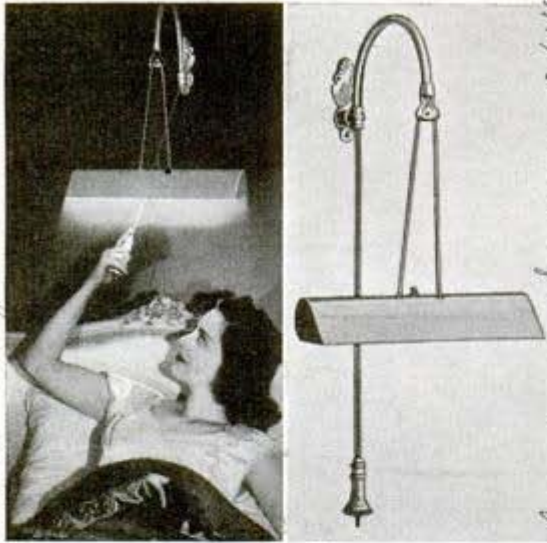

This "daylight" lamp, furnishing a good light for reading, is raised or lowered by moving the cord

Light at any height is afforded by a fluorescent wall lamp just brought out. It has a 14-watt, 15-inch bulb in a reflector. Particularly suitable for a bed lamp, it can be lowered to the best reading level by moving the cord, through which the wire passes to the standard plug.

Flexible Cable Removes Packing From Difficult Places

Fast removal of packing wedged in hard-to-reach places is possible with a handy hook and flexible cable now on the market. A corkscrew bit at one end of the cable is anchored by turning it into the packing, and a "T" handle at the other end provides a firm grip for pulling. Used in pairs, the

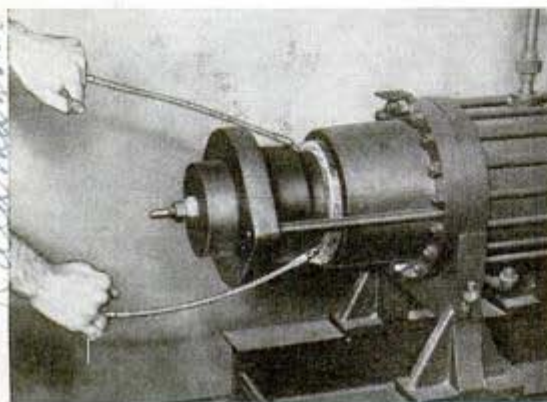

Packing comes out easily with a few tugs on handle of cable which is anchored by a couple of corkscrews

California Detinning Co
of Clarence Case, of
tools can be attached at opposite points for speedy action. According to the manufacturer, the cable cannot break when operated by hand.

New Process for Salvaging Tin To Save 40,000 Tons a Year

One California company has undertaken a salvaging program which, utilizing a new detinning process, calls for the recovery of tin from 40,000 tons of tin cans annually. With Malayan tin lost to the Japanese, this process may result in a considerable saving of the vital mineral in the United States. The cans are shredded by a hammer mill and the tin dissolved under pressure with a hot chemical solution. Then the tin is electrolytically deposited an inch thick on iron rolls and later cut and melted into pure tin pigs.

Automatic "Selector" Typewriter Types the Letter Desired



Pushbutton selects letter or individual paragraph

Any form letter or paragraph can be selected from a specially prepared group and "tuned in" to be written on an automatic typewriter, by pressing one of eighty selector buttons. The machine is actuated by two perforated paper rolls resembling music rolls used in player pianos. Each roll accommodates 200 lines of writing, which may be divided into complete letters, paragraphs, groups of paragraphs, or single-line and multiple-line billing entries. Eighty different selections are possible, and automatic "stops" may be placed anywhere in a paragraph or line permitting the operator to type fill-ins such as names of cities, individuals or products, or dates.

POPULAR MECHANICS
American Automatic
Typewriter Co.

Colonial Premier Co
466 W. Superior, Chicago

Drumman
Inventor
4/14/42

Clarence Case
California
630 W. 6th
P.O.

Styanometallic Corp
Kalamazoo

Chico
90
614 N. Carpenter

L1248

17

More Power for America

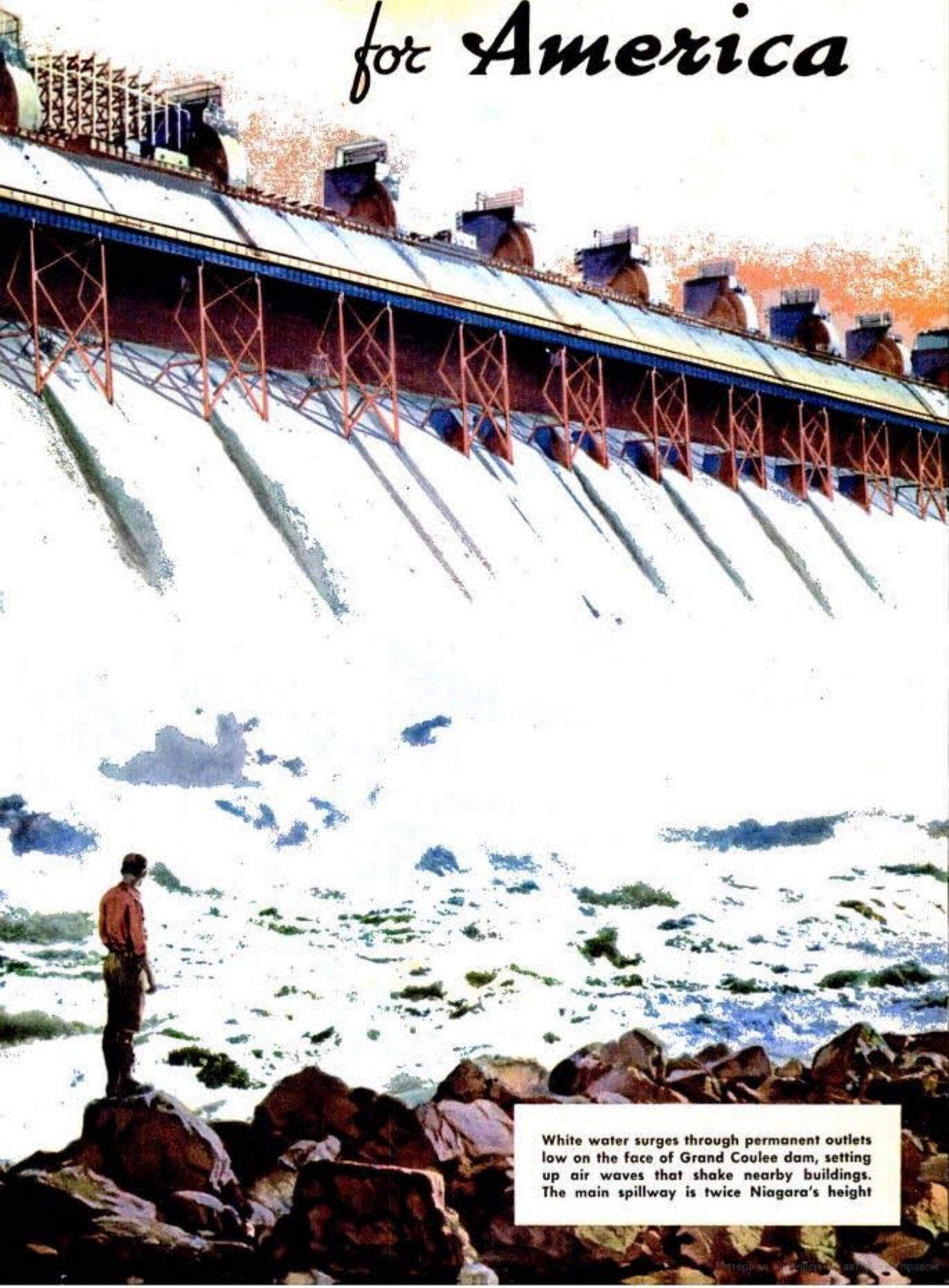

White water surges through permanent outlets low on the face of Grand Coulee dam, setting up air waves that shake nearby buildings. The main spillway is twice Niagara's height



18
 These huge nuts, used to couple the shaft of the waterwheel to the generator rotor, were shrunk with Dry Ice to 80 degrees below zero so they will expand and tighten after fitting



Rotor for one of the Grand Coulee generators weighs 587 tons and is 31 feet in diameter. Turning at 120 revolutions per minute, the speed of its outer rim is 130 miles an hour

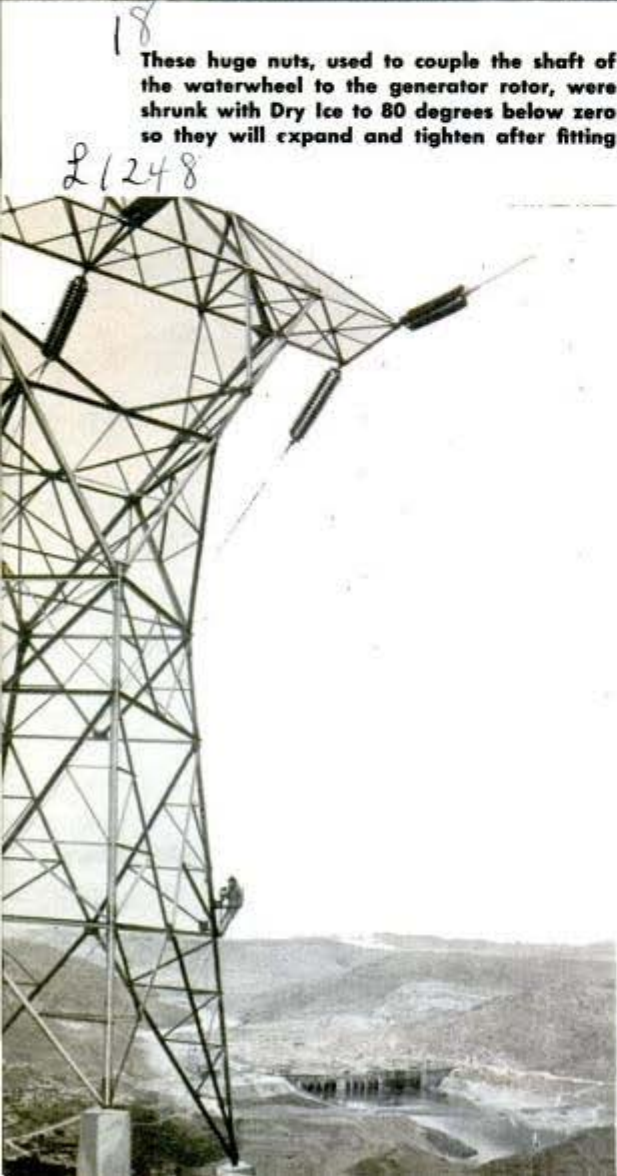

DURING the last few years the United States has tremendously speeded up its program of developing to the utmost the vast water-power resources of the country.

It is a good thing that we did because, suddenly, power in unprecedented amounts is needed to turn the wheels of our great rearmament industries. Ninety-six giant power projects were being completed or were under construction a little more than a year ago.

The most important of these hydroelectric developments, just now going into operation, is contained in the twin powerhouses of Grand Coulee dam in the state of Washington. Here 12,510,000,000 kilowatt-hours of electricity will be generated annually. Eighteen huge generators, driven by water turbines rated at 2,700,000 horsepower, are being installed.

One of these generators alone could illuminate one and a half million 60-watt lamps. Three of them could furnish normal lighting for New York City and Chicago combined. More important today, the output of one generator can produce 100 tons of aluminum a day, equivalent to half a dozen Flying Fortresses or 32 fighter

The human fly at left is measuring the sag of wires from one of more than 2,200 towers on a 450-mile transmission line

*Paul Thomas & Sons, Inc.
 3872 Franklin Ave. Los Angeles*

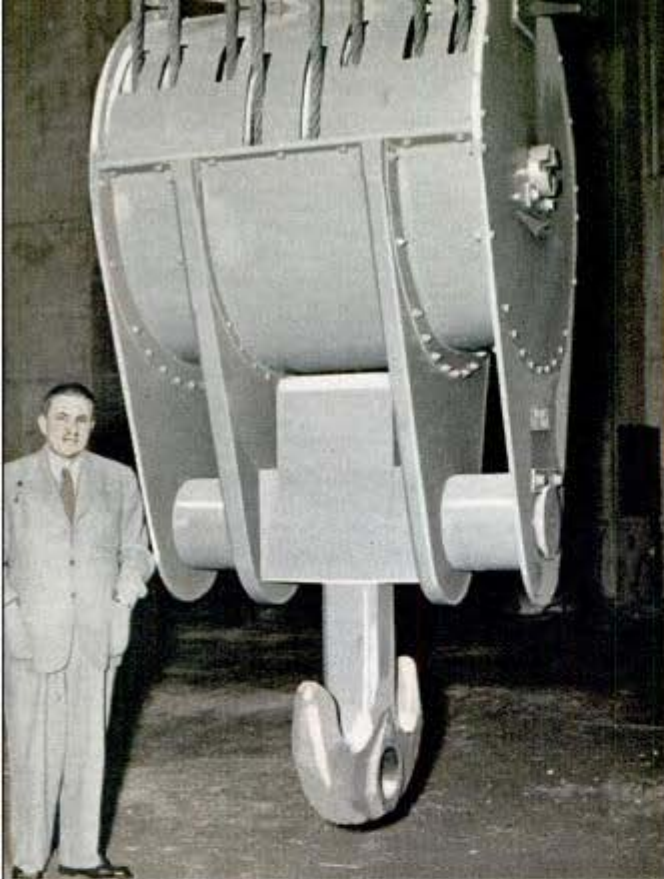

19
 This is one of the 175-ton crane hooks used for moving equipment in one of Grand Coulee's powerhouses. In man's most massive structure, everything is built in gigantic scale

L1248

planes. Last year no aluminum was being refined west of the Mississippi; this year one third of the nation's greatly expanded aluminum manufacturing capacity will be located in Washington State, using power extracted from the Columbia river.

Two of the Grand Coulee generators are now in use, a third is being assembled, and three more will go to work during the year. The rest will be installed as fast as they can be built if the demand for power continues.

These power units are three stories tall, the largest ever made. Each is costing one and a half million dollars. They are so big that each powerhouse really consists of a number of separate steel and concrete boxes, each containing and support-

View of trash racks and bridge piers during their construction



Here workmen are erecting an electric switching station. Every part of the power line from the dam to Vancouver, Seattle and Tacoma must be fully protected by automatic relays

ing a power unit and separated from its neighbors by cork expansion joints. Stairs and galleries make all parts of each unit accessible, down into the turbine pit where the roar of water rushing past the enclosed blades is too loud for conversation.

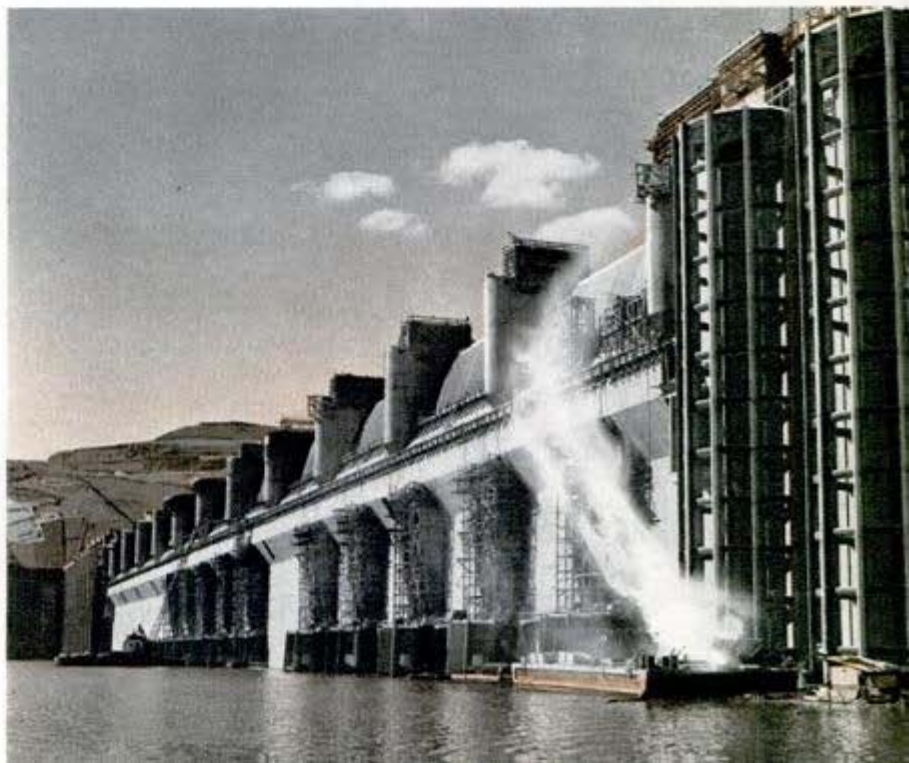



20 A section of outlet conduit is moved into its place

Assembling the coils of one of the 274-ton stators

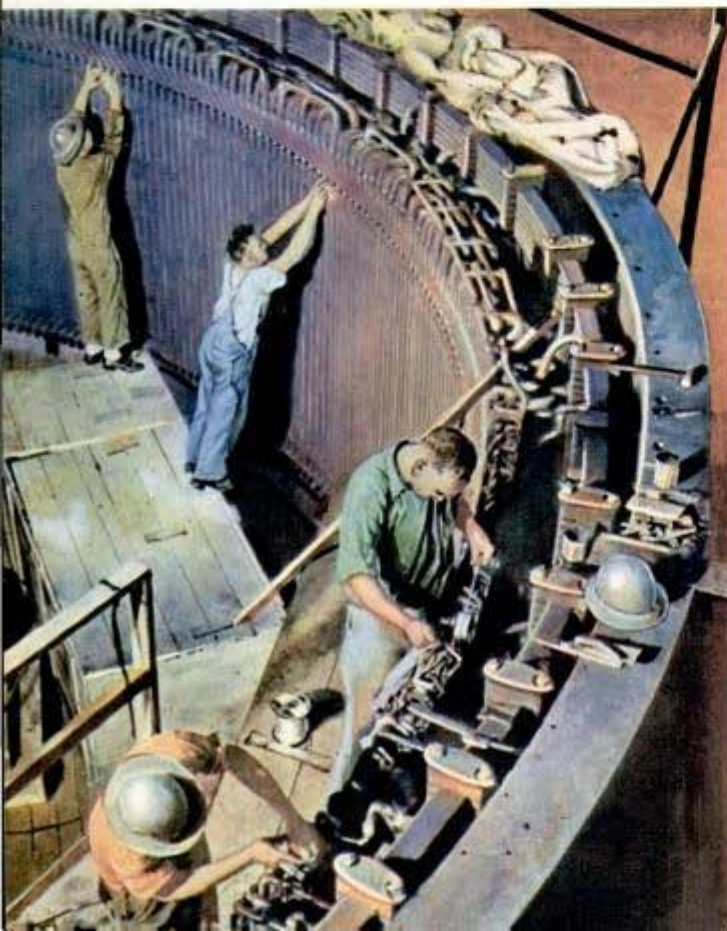

21248 Workman on safety line removes temporary construction material on lower face of the dam

Water from behind the dam flows through a steel penstock tube 18 feet in diameter and enters the turbine at 53 miles per hour. At full load 141 tons of water a second pass through the turbine. The water used by seven of them would supply the whole population with 150 gallons a day.

A steel shaft 44 inches in diameter connects the turbine with the electric generator above it. These power-manufacturing units are Westinghouse 3-phase, 60-cycle, 13,800-volt generators rated at 108,000 kilowatts. Each is enclosed in a housing 45 feet in diameter and is cooled by circulated air. The rotor turns at 120 revolutions per minute and the peripheral speed of its outer rim is 130 miles per hour. The entire rotating assembly, including the water wheel below, weighs 1,000 tons and is suspended from a thrust bearing on top of the generator. The stator frames are 37 feet in diameter and nearly 10 feet tall.

Sturdy as they are, the units were designed with the knowledge that they may need to be taken apart for repairs from time to time. Sections of the shaft that connect the water wheel with the generator are flanged and are joined together with oversize bolts that were temporarily shrunk down to size with Dry Ice when being installed. Holes have been drilled through the bolts so that liquid air can be shot through them to shrink them down again for removal. The entire rotating weight can be brought to a stop from 25 revolutions per minute in 60 seconds by air brakes which, when oil is

21248

21

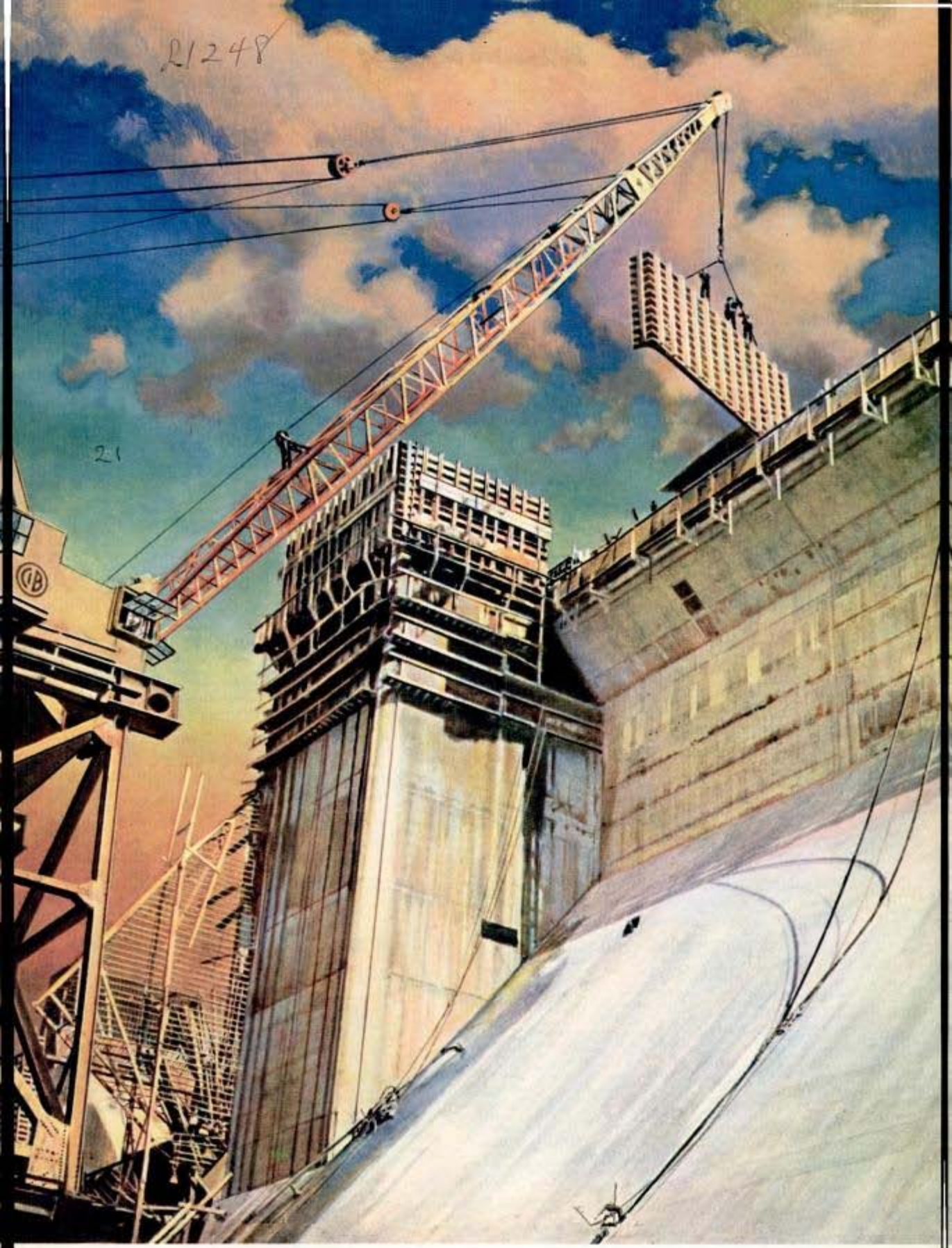

Here is one of the finishing touches—workmen completing the elevator shaft that will run from top to bottom of the structure. This view of a small area of the dam impresses you with its immensity; within the dimensions of the dam the entire population of the United States could be contained

*Ref: S. E. Hutton, director of Information
Bureau of Reclamation, Conlee Dam, Wash*

21248

Shail-like scroll case feeds water to turbine waterwheel at 53 miles an hour



lays. If one of the generators should break down, for instance, circuit breakers automatically open, turbine gates shut themselves, and carbon-dioxide gas is immediately released into the generator housing. Annunciators at the control stations show the location of electrical troubles, abnormal temperature changes, and interruptions of oil and water circulation. In addition to its main generators the installation includes three smaller service generators for local power needs.

22

substituted for the air, become hydraulic jacks by which the rotating parts can be raised.

Each unit has a local control station where it may be started and stopped, where load and temperatures are indicated, and where voltage and frequency are automatically maintained. An automatic governor on the turbine water gates changes the openings when the turbine speed varies as little as .01 percent. A main control room in each powerhouse is used to distribute loads among the generators, adjust frequencies and voltages, and operate circuit breakers. Every part of the electrical equipment is protected by automatic re-

Ice formation must be guarded against at several points. Water in the lake adjacent to the trash racks behind the dam is kept agitated in cold weather by an air bubbling system using air from compressors inside the dam. If spray from the spillway waterfall forms ice on insulators and conductors in the electrical switchyards above the powerhouses, these circuits can be isolated and shorted to a small generator that heats the system and melts off the ice.

Energy from the generators passes through transformers and is distributed to the Bonneville Power Administration, now finishing a 230,000-volt line to Puget Sound and a 115,000-volt line to Spokane.

Another big item is the 16-foot-tall bushing, below, which is to be fitted into one of the transformers

Light on top of Grand Coulee's first completed generator shows the 108,000-kilowatt unit is operating

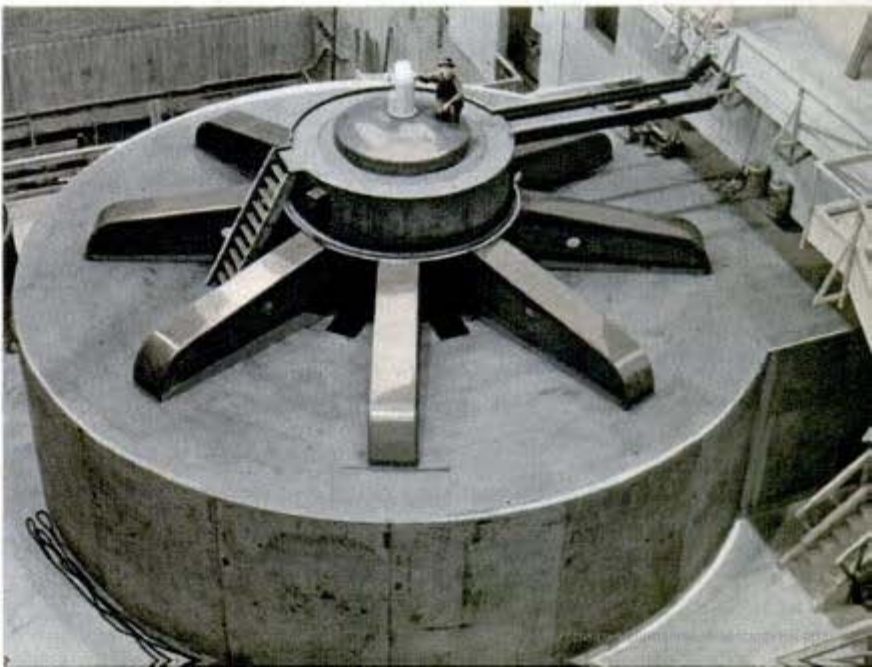

23

21248

The 4,300-foot Grand Coulee dam is the largest structure ever built by man. It holds back the Columbia river, second in flow only to the Mississippi, at a point in central Washington where millions of years ago a glacier blocked the river and caused it to cut a temporary channel at right angles to its normal course. The present development project includes a plan eventually to pump flood waters in excess of the Columbia's normal flow up into this old "grand coulee" and from there to distribute it to 1,200,000 acres of rich soil that now lie useless because of inadequate moisture. Power for pumping this water will be available from the billions of kilowatt hours that otherwise would go to waste during summer floods.

The whole population of the United States could be contained within the dimensions of the dam, so vast is the structure. It weighs twice as much as the nation's people. Its spillway forms a spectacular waterfall twice as high as Niagara. Across the top is a 135-foot highway.

Even when the spillways aren't in use the smaller volume of water cascading from permanent outlet holes lower in the dam sets up air waves powerful enough to vibrate wooden buildings in the vicinity. Erosion below the dam is prevented by a concrete "bucket" or artificial plunge pool at the foot of the spillway that is 90 feet wide and 30 feet deep. The interior of the dam is pierced by 8½ miles of inspection galleries, one of which contains a narrow-gauge railway track.

Right, one of eleven 500-ton drum gates on top of dam, which will divert flood waters over the spillways



↑
Portable X-ray machine rolls into the 18-foot penstock to examine its welded joints for any hidden flaws

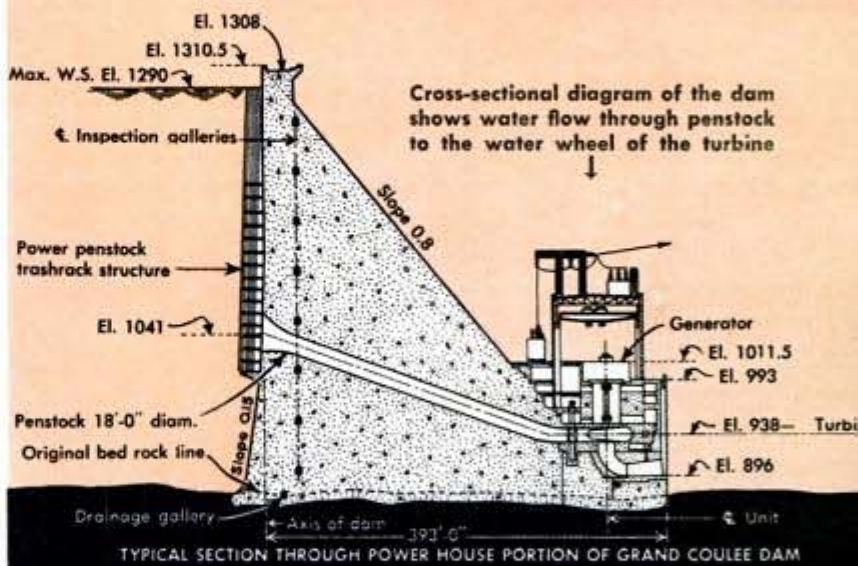

L1248

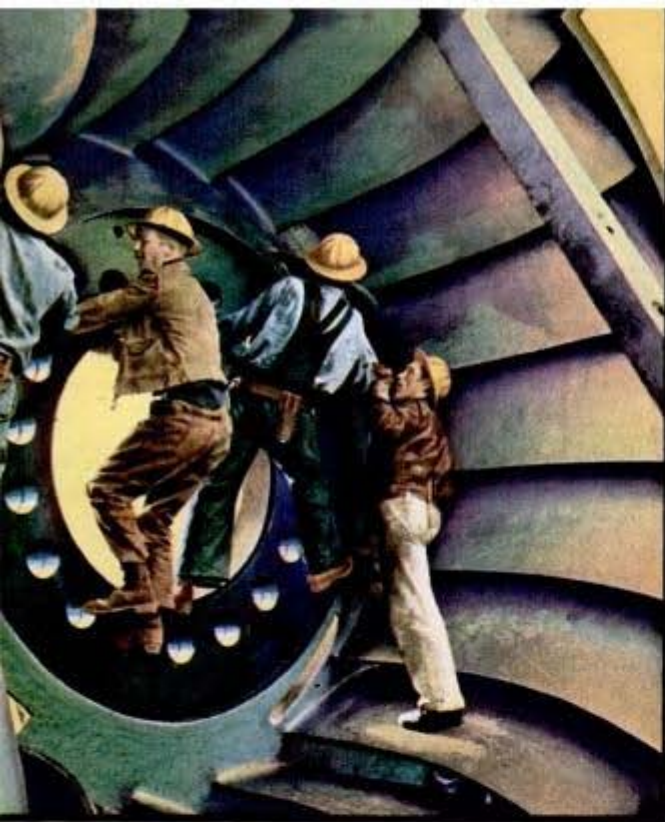

Above, water wheel for one of the 150,000-horsepower turbines. Below, aerial view showing flood waters being released from the lake piling up behind Grand Coulee dam. In foreground a small city has grown up

24

The dam supports a reservoir 151 miles long containing enough water to supply all of the needs of New York City for a 10-year period. Isolated as it is, the dam is visited by thousands weekly in the tourist season.

As much as possible, completion of the Grand Coulee power facilities as well as of other hydroelectric projects in other parts of the country are being rushed to completion because of the war. All such projects in the west have an additional purpose which eventually will be far more important than that of supplying power alone.

The 11 arid and semiarid western states contain 40 percent of the country's area, only nine percent of its population, and less than five percent of its farmed area. Vast tracts could be devoted to agriculture if only water were available. Already the Bureau of Reclamation has completed three dozen projects in the west by which the scanty rainfall is conserved and made available for irrigation. These projects cost some 250 million dollars but the nearly one million people who have settled on them have already produced a crop wealth of two and a half billion dollars.



M 162 *Com. Co. B. Hillingman*
504-7th Ave. Troy, N.Y.

Air Raid Car Is Packed With Fighting Tools

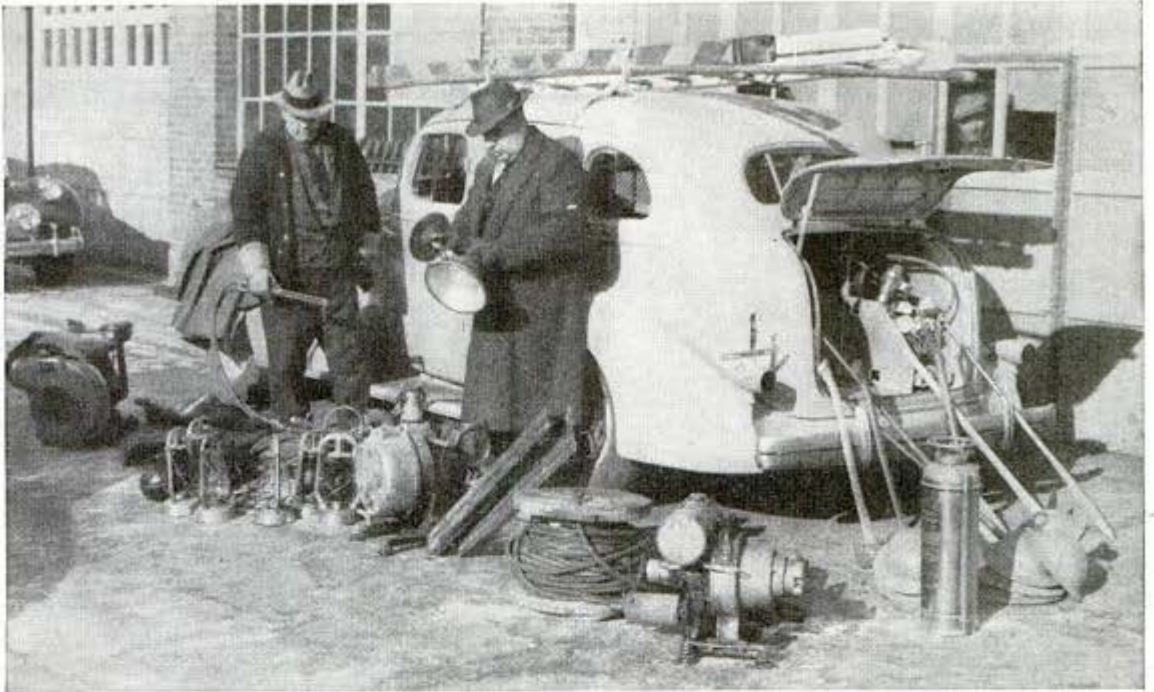

An ordinary sedan painted white and converted for air-raid use carries all this equipment for emergencies

From a discarded passenger automobile of one of its municipal departments, the city of Troy, N. Y., has created a well-equipped emergency car for use in air raids. Painted white, it has red blinker lights like those of ambulances and police

cars. In the rear seat and trunk and on the roof are packed acetylene torches, steel helmets, water pumps, gas masks, lanterns, ropes, chains, fire extinguishers, ladders, pike poles, battering rams and various other paraphernalia.

M 151

Mirror and Adjustable Target Teach Sighting and Aiming

At Camp Callan, Calif., new recruits are learning to sight a rifle without firing a

shot. With a new aiming and sighting apparatus the target is maneuvered into line

with the sight instead of moving the rifle, which is mounted immovable. The apparatus includes two parallel bars of wood a foot apart, at the far end of which a ten-cent mirror is attached. A circular piece of metal clamped to a wooden slab forms the target. Sighting and aiming are accomplished by adjusting the target until it is in line with the rifle sights as reflected in the mirror. The device is said to be foolproof and does away with hit-or-miss methods which were used formerly.

Corp. W. H. Jamini

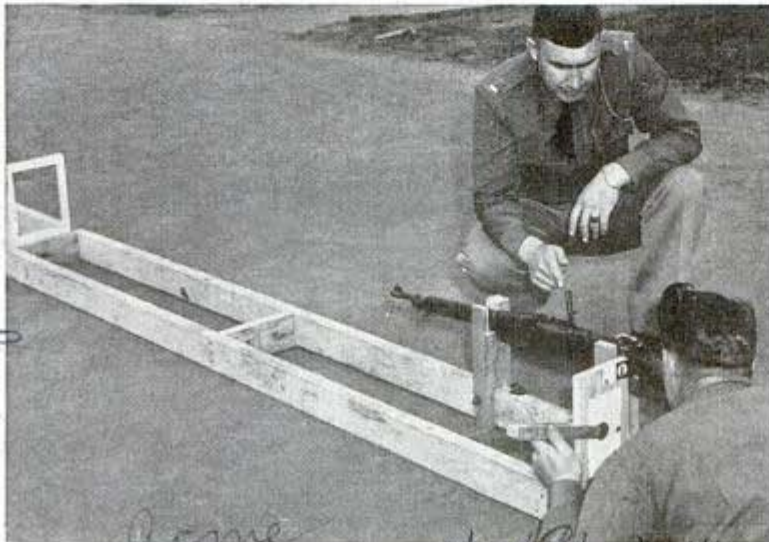

Recruit adjusts target until its reflection is in line with rifle sights

Acme
And Co. M. W. Hammond

M-169 by Major J. W. Wasth, England.

Bicyclist Tows Patients on Two-Deck Stretcher

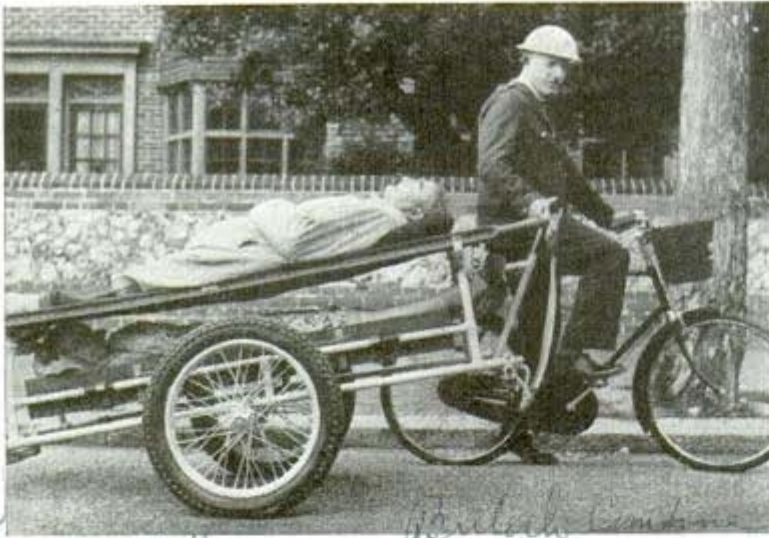

Two bomb victims can be carried to first aid headquarters on a double-deck stretcher designed for air raid work in England. The lightweight tubular metal frame which holds the two stretchers is mounted on a two-wheel dolly and can be towed by a bicyclist.

A British air-raid rescue worker, riding his bicycle, demonstrates how two victims of bombing are towed to hospital on two-deck stretcher

M-174

Trailer Carries Midget Cars in Upper and Lower Tiers

Hauling his two midget racing cars from one racetrack to another has been simplified by Duane Carter of Fresno, Calif., by borrowing an idea from the big automobile carriers. He now has a double-deck trailer on which both of the "pint size" racers can be loaded and hauled by his station wagon, which is equipped with sleeping quarters.

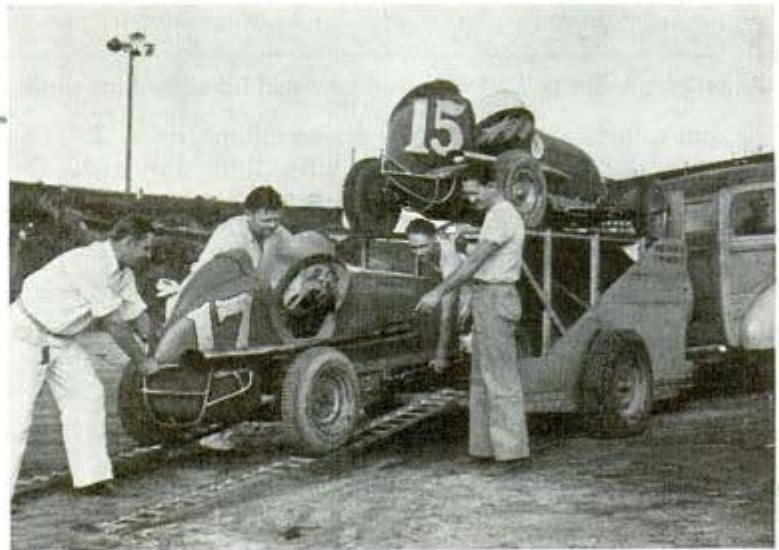

Two tracks between ground and floor of trailer make convenient ramp for loading midget racer

M-116

Folding Cradle for Stretchers Makes Any Truck an Ambulance

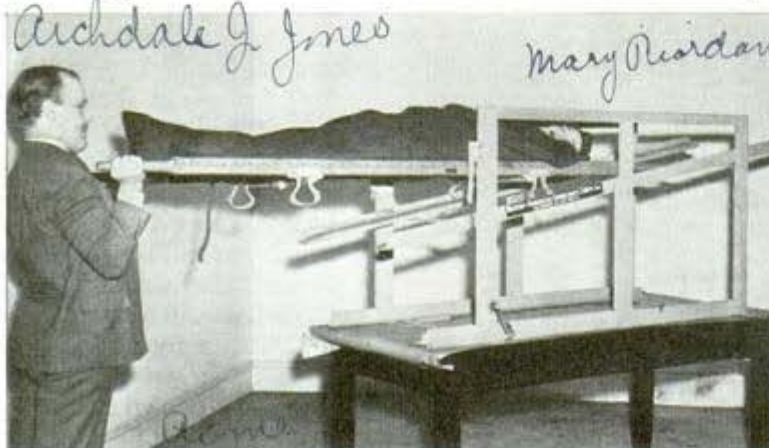

Any light delivery truck or station wagon can be converted instantly into an ambulance by means of a collapsible cradle built to hold two stretchers. Ruggedly constructed of wood and scrap steel, it folds compactly when not in use.

The hinged upper tracks of this cradle will slant downward to facilitate loading of top stretcher in ambulance

From Columbia News Service 420

420 Letting an ambulance

Traffic Loudspeaker Helps Guide Pedestrians



London policeman speaks instructions into microphone to help pedestrians cross street in safety

Policemen in Britain have started a new drive against traffic accidents involving pedestrians at busy intersections such as Trafalgar Square in London. A loud-

speaker mounted where it may be heard in all directions and a microphone held in the hand enable a policeman to instruct people how and when to cross the street.

m 132

Army's Latest Transport Plane Can Carry "Peep" Cars

Some of the latest technical advances attained by passenger airplane designers will

be included in a new giant military transport ship, when the first Curtiss-Condor C-46 rolls off the assembly line. Following a basic commercial-plane design which would carry 36 passengers and mail, the army plane will carry far more than 36 fully equipped soldiers, and can also carry light artillery and "peep" cars. Two Pratt and Whitney engines will give it a speed about equal to the fastest two-motored bombers.



Fuselage interior of new army plane reveals its enormous proportions

Human hair is used in a new textile fabric for women's dresses, shoes, hats and handbags made in a French factory.

United Press 27
26618730E
Merrill Lynch, Pierce, Fenner & Smith

418. 28th April
New York, N.Y.

ARMING CIVILIANS

For DEFENSE



Three dive bombers that have just dropped gas bombs are targets of riflemen training at a British airport

Barbed wire along the shore will impede an invading force but not stop it. Building defenses is a task never finished

Indebtedness is acknowledged to Tom Wintringham, organizer and former commander of Britain's Local Defense Volunteers, from whose book, "New Ways of War," (Penguin Books, New York) much of this article is condensed



DIVE bombers and tanks sweep France into helpless panic, and refugees clog roads that should be carrying armies. Fighting planes swoop down to machine-gun an English village. Armored cars roll through narrow streets of a town in the Ukraine.

Picture yourself in an invaded land. What could you, a civilian, do if your home were threatened?

The two foremost weapons of the blitzkrieg were planes and tanks. In the face of an air attack there are two things to do: keep your head and lie face down—in a hole if possible.

Tom Wintringham, veteran of the world war and the Spanish civil war and organizer of Britain's home guards, says of the plane: "It is a

At upper right, English girls learn to spot enemy planes for antiaircraft batteries. Diagram below shows how trench is dug in open field to wreck enemy planes that might land

weapon against morale. It does not in fact kill many men." In his "New Ways of War," written for the English people, he advises:

"Dive bombers are literally the most terrifying things that exist. There is only one thing to do about bombers: stay in a hole and pay attention to your business. Don't look at airplanes. They see faces more easily than anything else. Keep looking where the tanks or the enemy's infantry may appear. Then the bomber is less likely to spot you. Even if he does spot you, he is absolutely unable to hit you except by accident. Troops moving in close formation should scatter as soon as aircraft come over, but should not attempt to reach cover if it is more than 20 to 50 yards away. Break ranks, scatter, lie still, keep faces down."

Bombers cannot capture a country. It is their function to reduce resistance, to wreck fortifications and fac-

At right, civilian members of London's Auxiliary Fire Service man a trailer fire pump. Below, U. S. Signal Corps photo of plane strafing troops in First Army war maneuvers

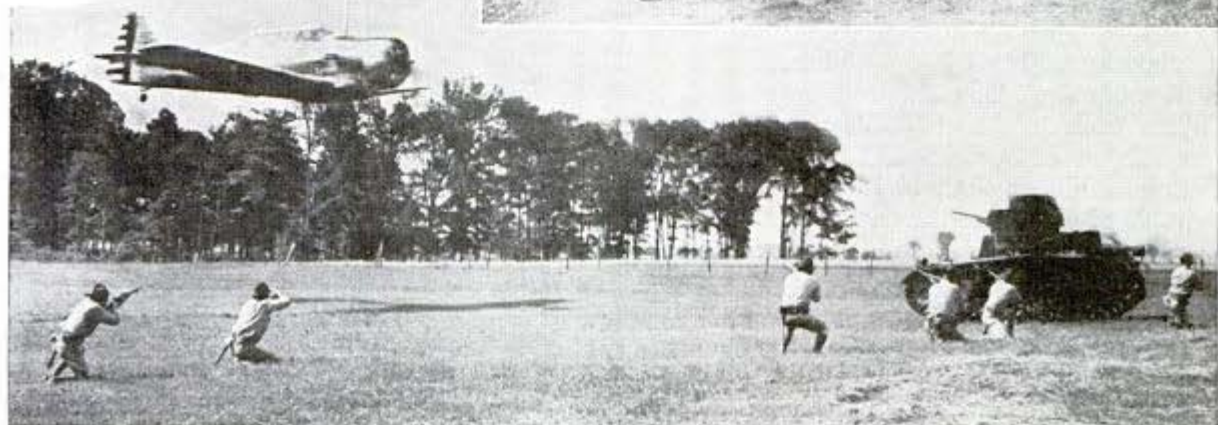
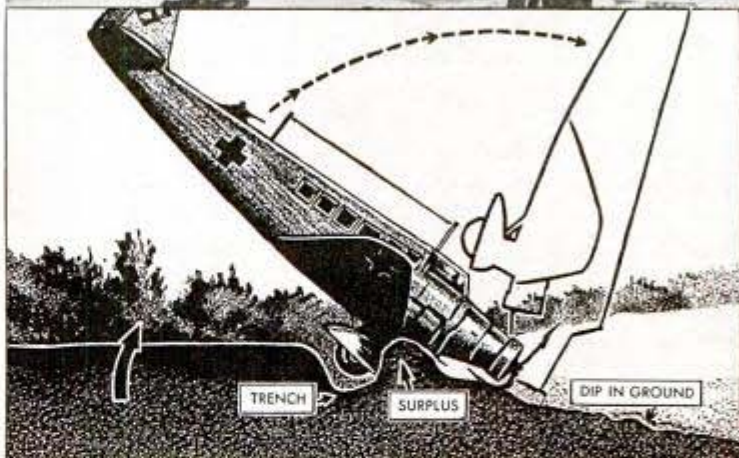



Spotters in control tower on British coast watch for signs of invader

Even portable blockades will slow mechanized invasion force and prevent planes from landing, once the road is useless to defending army

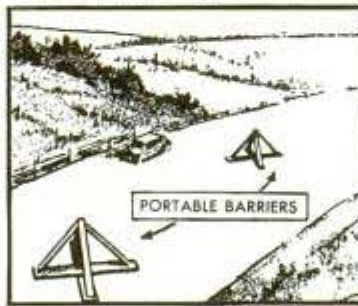
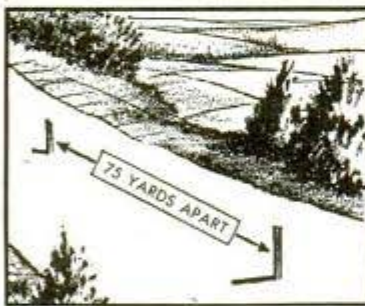

tories, to prepare the way for tanks and infantry. The Germans concentrated bombers most heavily where their armored units were held up; therefore, if a road block is to be effective, there must be a trench or dugout nearby where the defenders can hide from aerial bombs and still cover the blockade.

The tank is a formidable weapon, but the miners of Spain found a way to stop Fascist tanks in their civil war. Bringing parcels of explosives from the mines, they hid across the fields, behind trees or shrubs or in ditches. When the tanks came close, one of the miners would fling a packet of explosive, with fuse crackling, between the tank and the ground. And there was no tank! If the tank did not approach close

enough, men on each side would watch the direction the tank's guns were pointing. Bolting from cover on the safe side, one would race in to hurl his hand-made grenade. A tank's gun can seldom turn swiftly enough nor fire at sufficiently steep angle to catch a man crouching beside it.

U. S. Army units have experimented with gasoline bombs for halting tanks. This is simple and effective where the blazing gasoline penetrates into the interior of the tank. But in actual warfare, Wintringham found many a gasoline bomb lobbed on top of a tank would merely warm its roof, and if thrown on the road would splash harmlessly while the speedy tank rolled over it. Grenades containing a pound or pound and a half of explosive, he said, are far more efficient than guns, gasoline bombs or tank

British civilian defense volunteers practice aim on parachuting dummy



471 1403

traps. Most vulnerable parts of a tank are its tracks and cog wheels and, in some, the relatively unarmored underside. A crow-bar thrust at the right spot can disable a tank. Grenades set off by contact are useful. A man hidden in a ditch can haul a grenade across the road with a string just as the tank reaches it. The most dangerous distance from a tank is 200 yards; the safest, six inches.

Motorcycle scouts that usually precede the heavier mechanized units haven't much fire power, and offer good targets even at high speed. One stratagem that slowed Nazi cyclists on the continent was hanging a blanket on a rope across a narrow village street. When a motorcyclist comes up against such an obstacle he stops to find what's beyond; thus halted or slowed, he can be attacked with grenades or guns. Broken glass, or nails hammered through boards, may stop an armored car or cycle.

Every open field is a door ajar for the invader; the defenders must make it impossible for hostile planes to land. Trip wires can be strung across fields, about four feet high. Stout poles can be set in the ground about 50 feet apart, to knock the wings off any plane that attempts to come down. Trenches can be cut, about three feet deep and ten feet wide, one wall vertical and the other sloping, to catch the wheels of a fast-moving airplane.

Should actual land invasion of the United States ever occur, it is the hope and intention of the War Department that the Army will handle the situation without being impeded by civilians. In France, refugee traffic interfered with army reinforcements and supplies. Nevertheless American civilians must cooperate in certain phases if war ever comes to this continent—in maintaining order and production, in spotting enemy ships or planes, in enforcing blackouts. And there are some phases of home defense in which America can learn from Europe.

In England orders were given that automobiles not needed for defense units must be immobilized so that a competent enemy mechanic could not make them workable, else the Germans would find all the transport they needed if they captured a few towns. In Poland and France, German tanks drove up to filling stations and took gasoline from the pumps. All stations in an invaded region should be guarded, and

(Continued to page 176)

Steps Folding Under Truck Save Time and Energy

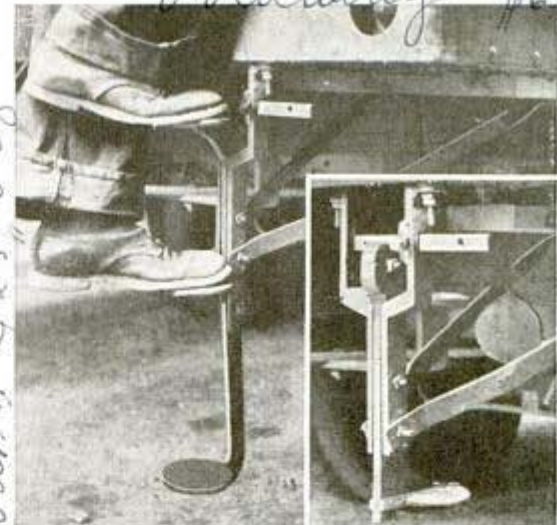

Steps, left, fold under the truck as shown at right

Less effort and time are needed in climbing in and out of a truck equipped with a pivoted step which is fitted with supporting brackets for attaching beneath the truck body. A touch of a lever folds the step out of the way with plenty of road clearance, and the step plates are inverted so snow, ice and dirt do not adhere to them.

Plastic Strips Replace Brass In Terrazzo Floor Design

Terrazzo floors hereafter may have designs outlined in colorful plastic strips instead of brass, because war production has rendered the metal scarce. As easy to lay as brass, the plastic strips can be formed in large circles, and the material is virtually nonflammable.

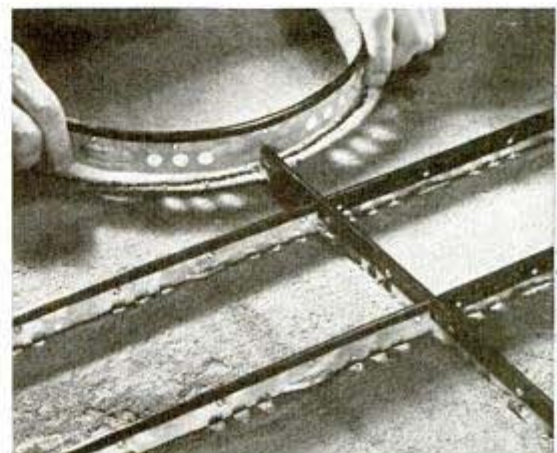

Plastic strip forms either circles or straight lines

Pat. # 2,250,838

Holdaway #600

J. Martocchio Inc. Co
W. N. Racine, Ill.

m 45

manhattan Terrazzo
c. m. 1915 - Paris den
N. Y. C. - 10th St. City

M130.

Pocket Postal Scale Weighs Letters Up to 2 Ounces

\$1.50



Balance scale for letters is carried in leather case

Having no springs, a balance postal-scale weighing letters up to two ounces retains its accuracy after long use. Letters clipped to an arm tilt the dial at the opposite side of the holder, and a pointer indicates the correct weight. Its leather case has two small pockets for stamps.

M100

Cookie Rollers in Three Designs Decorate Pastry Crusts

It is easy to decorate cookies, pie crusts, short breads and candies with artistic de-

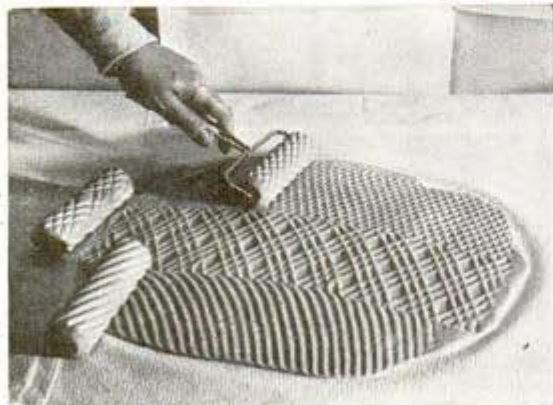

Three different designs printed on pastry with rollers

32

L. Lauerer Co
122 Chambers
New York City

Semisil Corp
132 W. 22nd St. New York

signs that rival the products of professionals. All you need is a handy baking tool supplied with three interchangeable rollers, each having a different pattern.

M46

Crayons of Known Melting Points Show Temperature of Metal

Welders and other metal workers can now find the approximate temperature of heated metal by marking it with a crayon that fits into a pocket. If a chalk mark appears when the crayon is drawn across it, the metal is colder than the temperature for which that particular piece of crayon is rated. When the rated temperature is reached, the mark melts into a liquid streak. Crayons are supplied to indicate various temperatures at convenient intervals from 125 to 1,600 degrees Fahrenheit.

M149

Ankle Reflectors for Blackouts Help Protect Pedestrians



Ankle reflectors make wearer visible in a blackout

To make pedestrians more visible in a blackout, safety reflectors worn on the ankles have been introduced. Mounted on a strap that encircles the ankle, the reflector catches stray beams of light which can be seen from within a short range.

Radio engineers of the British Navy have developed a compact transmitter in a waterproof, buoyant case which is automatically thrown overboard from an abandoned ship to be picked up by survivors, who may then broadcast their position.

See Sec. Eng. Jan
42

Purdson. W and 'dme.
11 W. 42 nd St. New York City

m 80.

Caproni - Campini. C.C. 2.

Airplane Driven by Air Jet Is Developed in Italy

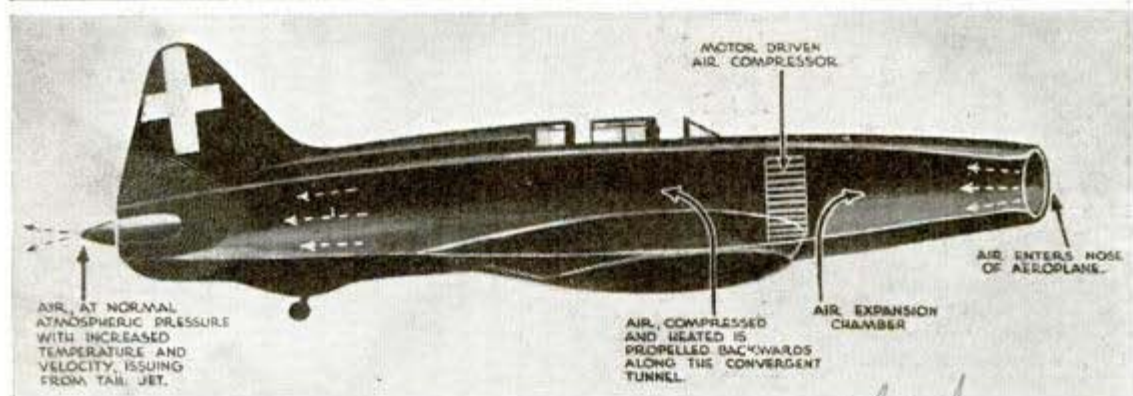
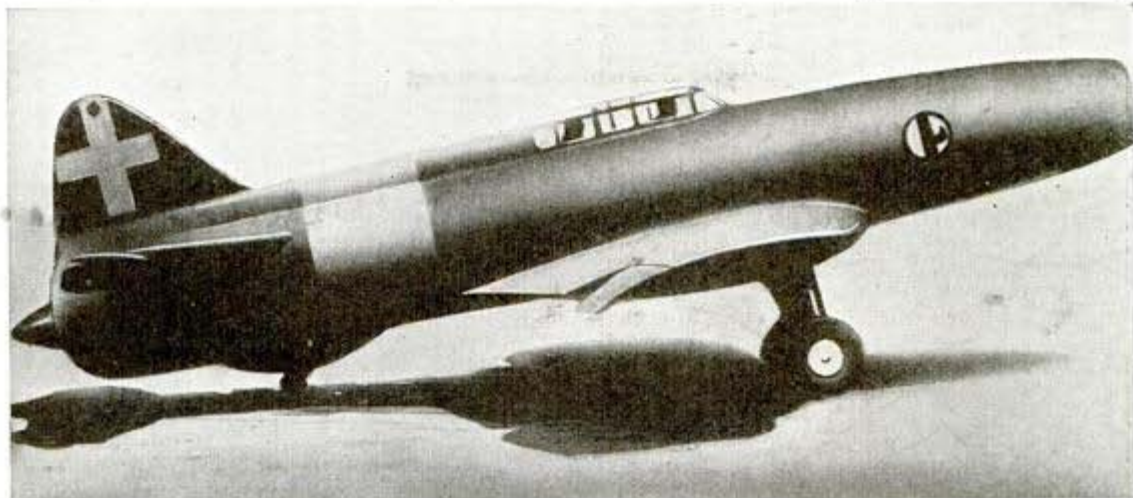

Courtesy "The Aeroplane," England

Top, photo of Italian airplane which is propelled by jet of air. Sketch, bottom, points out details

From Italy comes word that an engineer named Secondo Campini has invented and tested a propellerless airplane driven by a jet of air. The plane draws air into a large duct in its nose, compresses and heats it in a tunnel in the fuselage, and expels the air with great force from a jet in the tail. This

should not be confused with the rocket plane, in which the propelling force is created by the rush of gases from combustion of the fuel itself. In a test flight, the jet-propelled ship is reported to have flown from Milan to Rome in two and a quarter hours, averaging about 130 miles an hour.

Blackout Awning Seals the Window Against Light Leaks

Inconvenience of plunging your home into darkness during a blackout can be averted by installing a metal awning that

closes about the window completely and prevents any light from seeping outdoors. Made of rustproof galvanized iron, it guards the window against shattering as a result of explosions or flying bomb fragments. The awning is fireproof, and serves the ordinary purpose of keeping the sun's glare and heat out of the room. An inside lock prevents the entrance of prowlers.

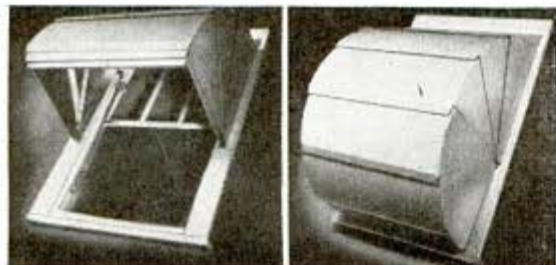

Awning open half way, left, and closed for blackout

Write to the firms listed in the Where-to-Buy-It index to learn more about products described in this magazine. Say You Saw It in Popular Mechanics.

SPORTS SECRETS *in a* FLASH

By AUSTIN S. MYERS
and
GEORGE H. TEMPLE, Jr.

Research Laboratory,
A. G. Spalding & Bros., Inc.

Cheaper, more
SPORTS equipment is being improved with the aid of high-speed pictures, taken in 1/30,000 second or less, which not only expose faulty design in clubs, rackets and balls but also reveal secrets of form that can be employed to teach both amateur and professional how to play the game better.

For the first time, the basic principles of golf, tennis and other sports are being determined, giving manufacturers a basis for sound scientific design of equipment. One result is a golf club with a properly curved face that straightens out the duffer's drives in an almost miraculous manner. The curved face "bends" toe shots so that they overcome their tendency to hook and corrects heel shots that ordinarily would result in slices.

Super-fast photographs,

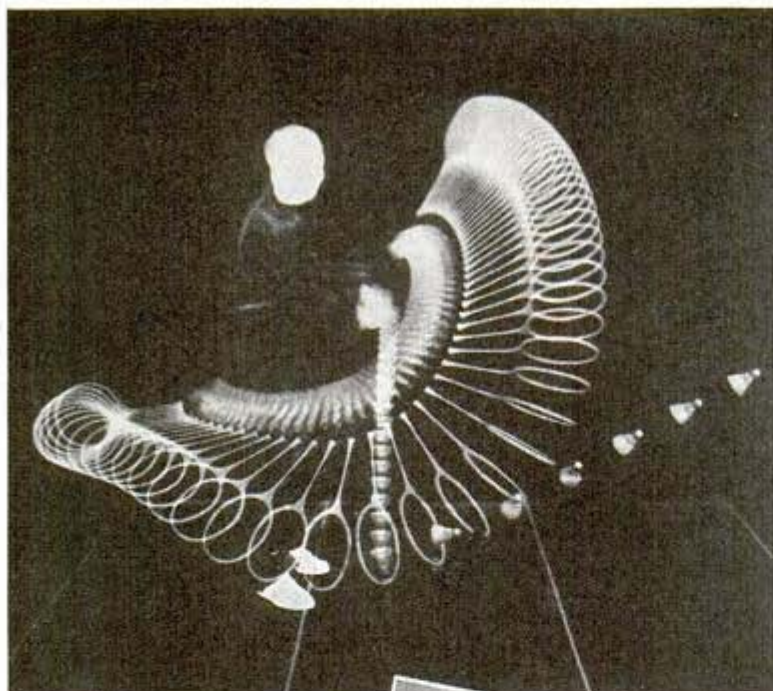

Photos © A. G. Spalding & Bros., Inc.

↑
Notice how quickly the bird straightens out in this multi-exposure shot of a beautifully symmetrical badminton service

Despite its effectiveness the baseball pitch seems awkward at this stage, caught by the flash camera in 1/30,000 second →

This view shows device for tripping camera; ordinarily the shot would be made when the ball and bat meet ↓



Multi-exposure of baseball batter taken at 100 exposures per second
Copyright by A. G. Spalding & Bros., Inc.

2211

made by methods worked out by Dr. Harold Edgerton and his associates at Massachusetts Institute of Technology, prove that when a football player like Sid Luckman of the champion Chicago Bears kicks, he actually digs his toe a considerable distance into the ball. How hard the ball is kicked, how much it spins and tumbles after the kick and how a professional player like Luckman does it, also are revealed. Work of this nature results in better football equipment and eventually will act as a foundation for instructional information covering certain phases of the game.

In baseball, the pictures show the bat bending after meeting the ball, the pitcher's arm crooking in an awkward manner midway of the delivery and the ball partly flattening against the bat at the moment of impact. Similarly, a tennis ball flattening against the racket and the racket



Ghost-like is this multi-exposure of basketball player shooting a goal, with position of hand and angle of shot being demonstrated clearly

bending after the impact are exposed by the camera, which also catches odd, sometimes terrifying expressions and gestures characteristic of the individual player in action. Contributing to the manufacturer's information about badminton are flashes of the shuttlecock—the bird—instantly reversing its direction of flight after impact and of the racket bending an appreciable distance.

A. G. Spalding & Bros., through the use of high-speed photography methods, have utilized stroboscopic analysis for studying sports and equipment. The analysis is dependent upon the aid of special electronic circuits and control devices, and special gas-filled discharge tubes. High-speed flash photographs are taken by storing up electrical energy and then, at the time desired, discharging this energy through the gas-filled tubes. These tubes emit a sufficient intensity of light to expose a photographic film in 1/30,000 second, or less, depending upon the

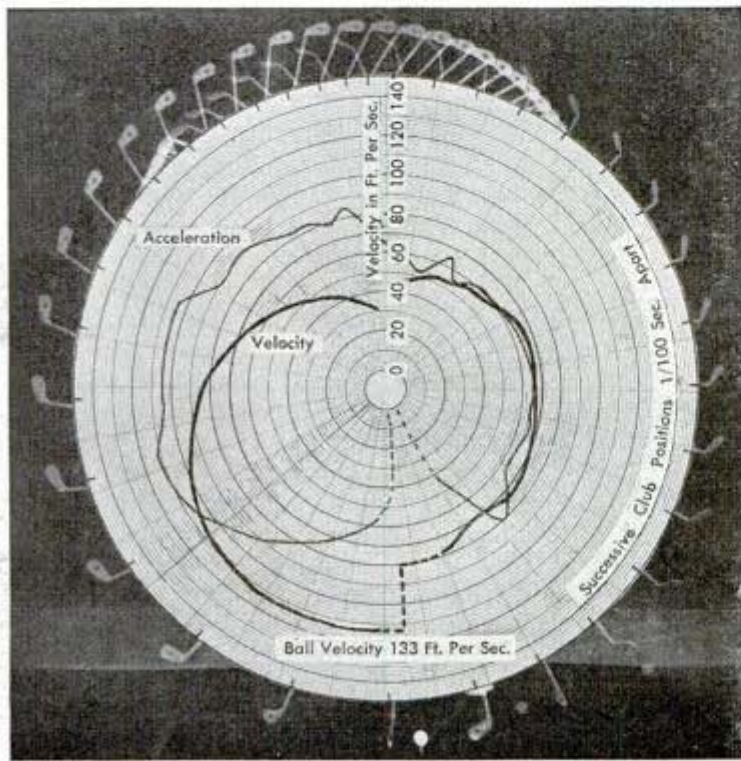

Laid over a multi-exposure photograph, this "Stroke-ometer" chart analyzes golf stroke

M-11

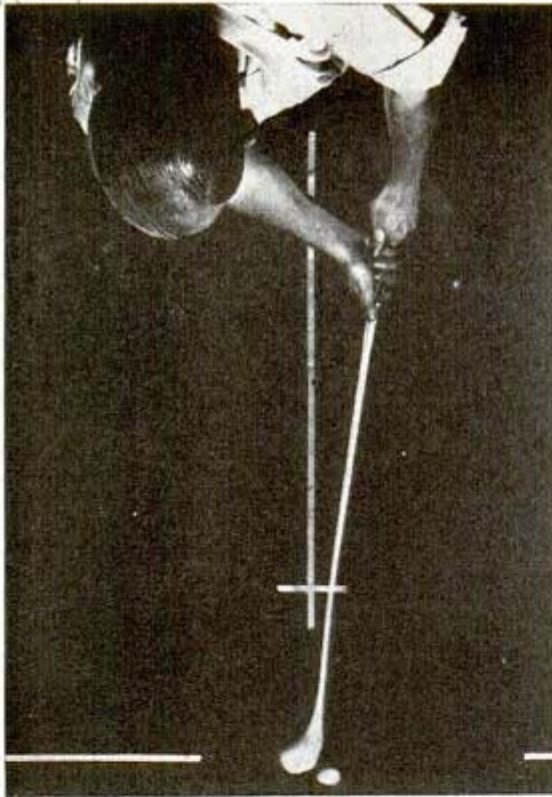

Overhead view in 1/30,000 second showing lead of hands happens to catch a shot that was poorly hit

type of electronic circuit used. Photographs have been taken in 3/1,000,000 second. The discharge of the stored electrical energy that produces the light is synchronized with the camera shutter in a manner similar to that for standard flash "guns."

If the discharging of electrical energy through the special tubes is repeated rapidly, the result is a series of intense flashes of light of very short duration, stroboscopic light, that enables one to see several successive positions of a rapidly moving object, such as a golfer driving. Spalding's multiple-exposure photographic technique consists of using a very intense stroboscopic light to record on a single photographic film several images of a single-action sequence. A photo of this type is not an accidental "double exposure," but several intentional exposures on one negative.

By an analysis of multi-exposure photographs, sometimes supplemented by a sequence of single-flash photographs, one can determine the velocity and acceleration of any moving element, the magnitude of deflections, the magnitude and direction of forces, energy relationships, the rate and amplitude of vibrations, rotational speeds, weight distributions and other factors. Thus are being determined the fundamental principles of various sports.

In making multi-exposure photographs which will not result in a blur of images of the fast-moving player against an over-exposed background, the player wears a black velvet suit and works on and in front of a background of the same material. If a football uniform had been used in pictures of Sid Luckman punting, for instance, it would have photographed as an extreme white because of the intense light and the superimposed body motion; consequently detail of the hands and the ball would have been lost in the white mass of the uniform. The black suit and background result in a ghostlike photograph which shows hands, feet and face of player, and the ball at closely spaced intervals of the action.

Because the physical principles

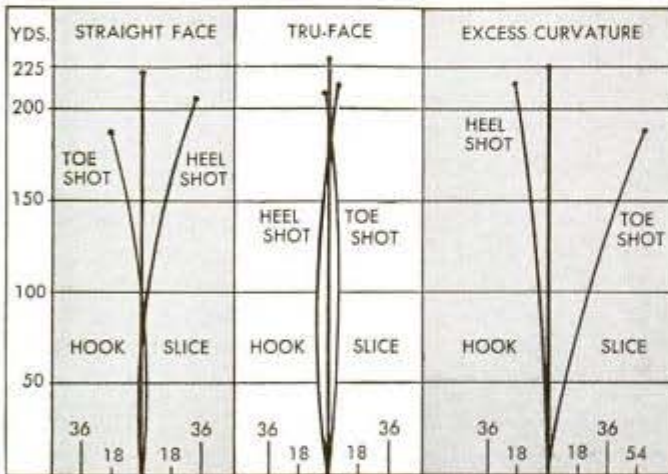

© A. G. Spalding & Bros., Inc.
Photos below compare straight-face club with curved surface of new "Tru-Face" club; diagrams above illustrate effect of clubs on driven ball

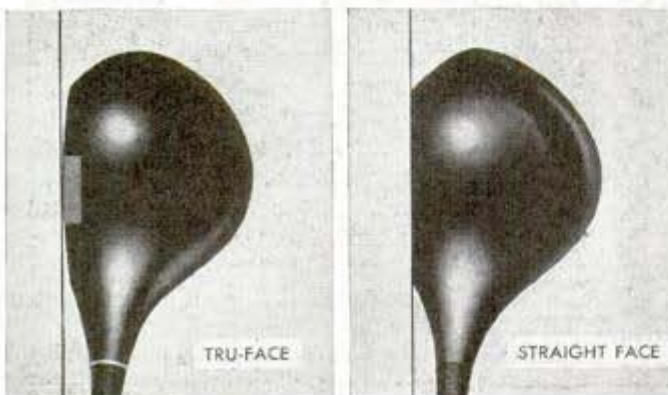

m-11

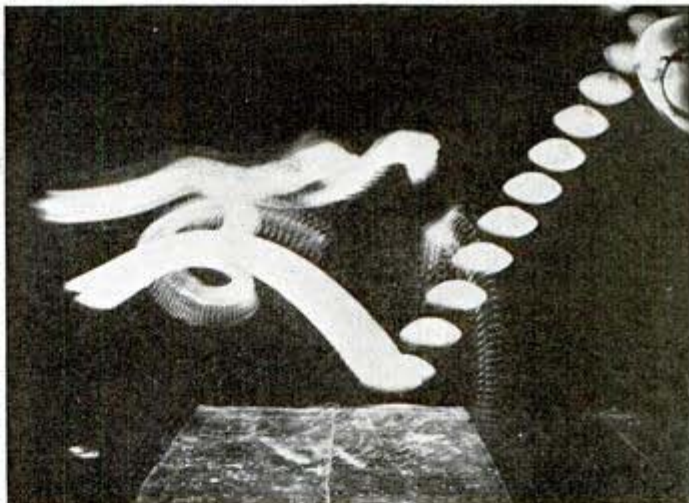

© A. G. Spalding & Bros., Inc.

Single-flash photo in 1/30,000 second, left, catches impact of place kick; right, multi-exposure of punt

involved in golf are more complex than in most other sports, the Spalding laboratory has worked longer on an analysis of golf equipment than any other sport. What happens when the club face meets the ball in an ordinary drive? In a series of single-flash pictures taken with an exposure time of $3/1,000,000$ second, the initial contact, the flattening and the recoil of the ball from the club face can be clearly seen. Thus it is found that the ball reaches substantially its maximum flattening before its front edge moves forward at all. Similar photographs reveal that club and ball are in contact only .0004 second—certainly not long enough for the golfer to manipulate the ball during impact, as some golfers boast. Another interesting point is that at the moment of impact, an average force of one ton is applied to the ball—just a hint

of the punishment a ball takes every time it is driven. Other valuable clues to the stresses to which the interior of the ball is subjected are uncovered in high speed pictures that reveal how, as the ball is compressed horizontally by the club, its vertical diameter elongates. And, similarly, as the ball reacts from the compression, in leaving the club, the horizontal diameter is stretched and the vertical shortened.

The curved-face golf club, known as the "Tru-Face," with which the duffer may come close to duplicating the long, straight drives of an expert, had its beginning in high-speed photographs. From the pictures, the research engineers were able to observe and measure the gearlike action between the ball and the face of the club which produces sidespin when the contact

(Continued to page 165)

Left, ordinary golfer's swing; right, Bobby Jones's swing. Notice that intervals between club positions in second half of Jones's downswing are greater as uncocking of wrists continually increases club head speed

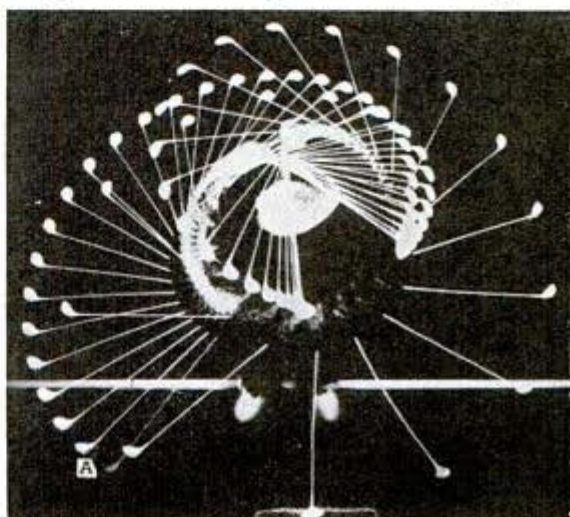
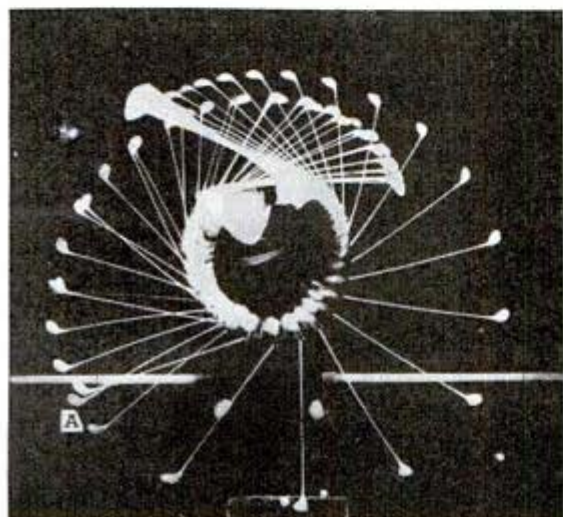

M 74 Jack Tiffany, inventor

Bubble Boat Hauled on Car Is Inflated by Pump

Barberton Ohio



← Outboard motor may be mounted on special backboard bolted to the frame of "bubble boat"

Upon arrival at beach, the boats are unloaded from top of car and inflated with a tire pump

Jed Connel

Riding the waves on a platter-shaped boat is a new fad offered by Jack Tiffany, inventor, of Youngstown, O. The craft, aptly named a "bubble boat," is a circle of tubing covered with rubberized canvas, which floats when inflated. The canvas contains two air compartments which may be filled by a tire pump. For mounting an outboard motor, a backboard is bolted to the frame of the waferlike boat.



Hot Seat

Holes in All-Plastic Fruit Knife Save Juice While Cutting

Several holes drilled through the blade of a one-piece plastic fruit knife are said to prevent the loss of juice in cutting fruits

and vegetables. It peels, slices and cuts all varieties, and its keenness can be restored easily by scraping both sides of the finely serrated edge with an ordinary metal knife. The knife comes in shell pink, crystal clear, Nile green and sapphire blue.

M 137

Light Bulbs Use But Five Percent Of Total Electric Energy

American homes burned up 25,750,000,000 kilowatt hours of electrical energy last year, which was but 18.3 percent of the total of 140,340,000,000 kilowatt hours used for all purposes throughout the nation. The remaining 81.7 percent of electrical power was consumed in industry and transportation. Although the electric light bulb is the most used "appliance" in the home, it takes only a fraction over five per-



Fruit knife made entirely of plastic has several holes in its blade, said to help retain the juice

P. C. C. Creations Inc. Atlantic City N.J.

420 Lexington Ave
New York City

m93

cent of the total power, the Edison Electric Institute estimates. After the light bulb, the home appliances consuming most power are the refrigerator (5,645,000,000 kilowatt hours), electric range, water heater, radio, flatiron, oil burner, washing machine, vacuum cleaner, roaster, percolator, toaster, electric clock (193,000,000 kilowatt hours) and ironing machine.

Army Hut Models Help Recruits Learn Camp Construction

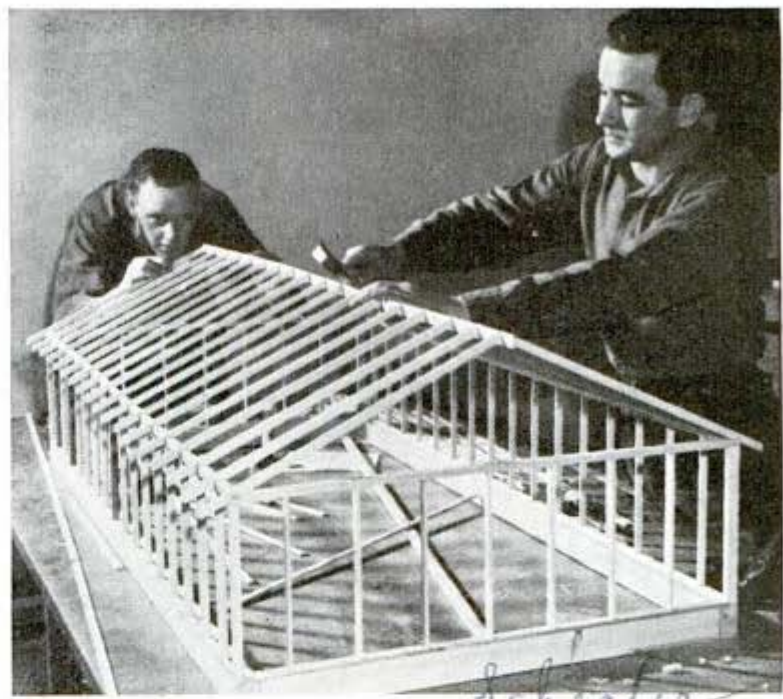

Carpenters learning to build army huts erected this model for practice

Holes Cut in Ladder Top Hold Tools For Workman

Convenient for carpenters and shop workers is a ladder with holes cut in the top step to accommodate various tools. There is a slot shaped for a chisel, another for the hammer, and so on. The tools are always handy and cannot be brushed off.

m 51

West: Ira B. Fry, Merchandise Mart



Slots in top of ladder fit the various tools, which are kept from falling and are always in easy reach

Small models of army huts, correct in every detail, are being assembled by Canadian Army recruits who are learning details of huts for use on camp sites. These men are studying carpentry and woodwork, and their practice with the models will teach them how to solve problems to be faced when they build the real thing.

m 82

Blackout Cane Carries Flashlight Fastened Near Handle

Pedestrians can now light their way during a blackout with a flashlight cane introduced recently. Fitted with a clip like those used on vest-pocket pencils, the flashlight fastens to a leather band near the handle of the cane. Both the flashlight and leather band may be removed readily.



Focused downward, the beam projects beyond the tip of the cane, illuminating a small area directly ahead of the feet.

New York City

Handwritten notes and signatures at the bottom of the page.

1297

Emb. John A. Miller of Transit Company
33rd St. 42nd St. 1st Ave. 1st St.



Special shades are fitted over the rear lights of motorcycles used to lead buses and streetcars in Manchester, England, in fog or blackout

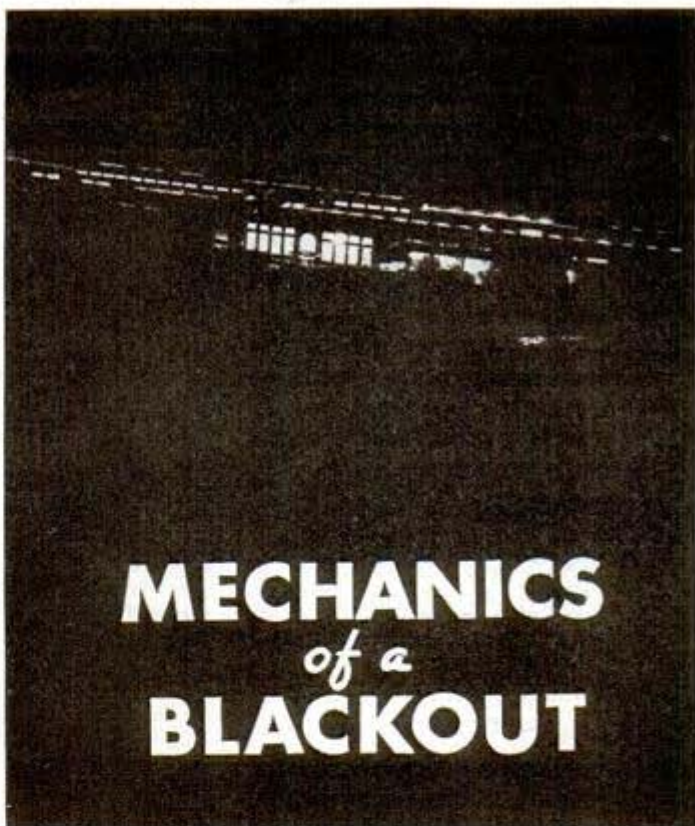

MECHANICS of a BLACKOUT

Newark News photo

Here is Newark, N. J., in a blackout test. Only lights permitted were those in the Pennsylvania Railroad station



WAILING sirens send shivers down thousands of spines, and a great city swiftly and methodically resolves itself into self-imposed paralysis.

Motorists caught in the blackout pull up to the curb and turn out all lights. Home windows are curtained, skyscrapers suddenly go dark, street cars grind to a halt, flashing neon signs vanish from the skyline one by one, and for a brief moment the only lights visible are the red and green dots of traffic signals. Then they, too, fade into the blackness and there is only an occasional stab of a flashlight or the flicker of a match cupped between hands to light a cigarette.

In the coastal city the blackout is real; farther inland it may be only practice. Anywhere, it is eerie.

At first the public, resentful of a neighbor's careless lights or a brilliant shop window or advertising sign neglected in the night "alert," wondered why you couldn't just pull a master switch in the power station and blacken the entire city.

Touches of white on clothing of pedestrians make them more visible on darkened streets and walks

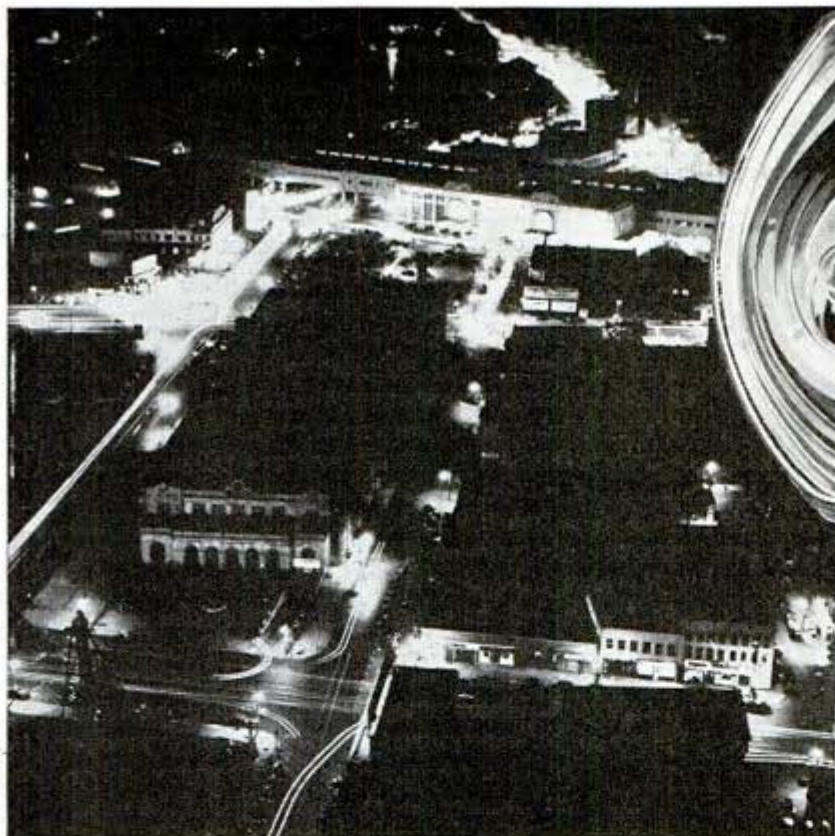

↑ Low-power argon lamp with "admiral's hat" reflector for street lighting during a "dimout"

← Brightly lighted streets of Newark as seen just before blackout shown on opposite page

But it is not so easy as that. Alarm systems must not be disrupted by a power cutoff, elevators and electric stoves and heaters need not be. That is the reason for experimental blackouts in interior cities fairly safe from air attack. There must be order in the seeming chaos of darkness.

For the ordinary citizen a blackout involves only inconvenience and a little discomfort. If he is driving his automobile he stops and extinguishes lights. If he is walking he can stumble on in darkness or wait until the lights come on again. If he is at home he simply puts out the lights or blankets the windows. Or he might follow the example of Henry Prescott, paint company executive, who has outlined in luminous paint the tables,



London direction signs were visible at night under large metal shades hiding them from above



Placing masks over headlights of a fire truck in preparation for a run during a blackout test. Traffic in the blackout is dangerous and nonessential cars must be kept off streets

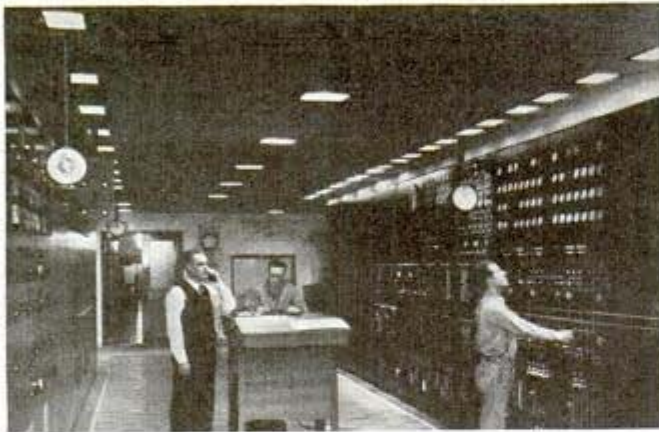

Operators in a power substation watch rapidly changing indicators of meters as a blackout cuts down the electrical load

As the load on transmission lines drops sharply, engineers in the power company's dispatching office issue necessary orders

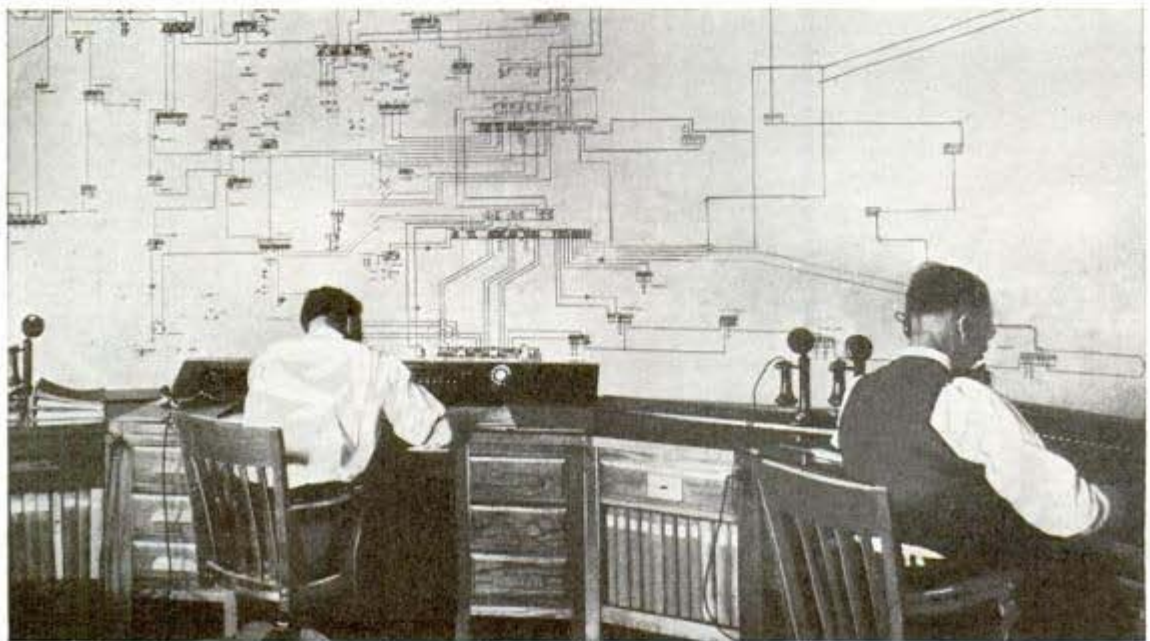

chairs and other objects in his Mt. Kisco, N. Y., home. This makes them faintly visible at night when all lights are turned out, and permits most ordinary activities to be continued during the blackout without going to the trouble of curtaining the windows. Luminous paint has been widely used in Europe, but generally on outdoor objects.

The real problems of a blackout are those of police and fire departments, transportation companies, hotels and electric utilities. The life of a big city cannot stop entirely even for a 15-minute period.

Even before the sirens give the "lights out" signal, a load dispatcher at the power house of the electric company is watching the indicator to see how much electrical energy his generators are furnishing to customers. The indicator has been dropping slowly for nearly an hour as people have been turning out lights and going to bed. Then comes the strident wail, warning of danger. Trolleys stop. Lights disappear. The indicator plummets downward.

At Pittsburgh the Duquesne Light Company is said to have dropped about 75,000 kilowatts of electric load when the practice blackout signal sounded. That is

01297
equivalent to about two million ordinary electric lights, more than the total load in many a small city. This load had to be picked up again immediately when the "all clear" sounded. As a matter of fact, the electric load picked up after a blackout is likely to be greater than that dropped at its beginning, as the simultaneous starting of street cars all over the city creates a specially heavy power demand.

This problem is not new to the power companies. They have to handle sudden changes of load in their regular business. The load dropped during a blackout may, in fact, be less than that dropped during the noon-hour shutdown of a working day. Automatic machinery in the power station is designed to take care of such changes. When the load on the generators begins to decline the draft blowers for the boilers automatically slow down and steam supply diminishes. When the load increases the blowers speed up and provide more steam.

Transportation companies have more difficult problems. Special precautions must be taken to protect the thousands of people riding in the companies' vehicles. During practice blackouts in Seattle, Pittsburgh, Newark and Toronto, all street cars and buses were halted to prevent accidents. But in a protracted blackout the procedure would probably be different, as there would be no way of foretelling the duration of the danger and you can't stop transportation service indefinitely.

In British cities the surface vehicles reduce speed during blackouts, but continue to operate with shaded lights until actual bombing begins. Numerous accidents have occurred as a result of this practice.

Service was halted in Newark's 4½-mile trolley subway during the trial blackout. Part of this route is under cover, part in an open cut, but the signal lights for both parts are on a single power circuit, and it was decided that the entire signal system should be turned off. This meant that the cars could not continue to operate, even under cover. London's "Underground" keeps running during air raids. Its operation is somewhat hampered by the use of many stations as shelters, but most raids take place at night when travel is relatively light. Whatever might be done in this country about subway operations during an air raid, the use of subway stations as shelters would not be very satisfactory or

(Continued to page 162)

m49
**Track-Riding Drawing Tool
Traces Model Outline**

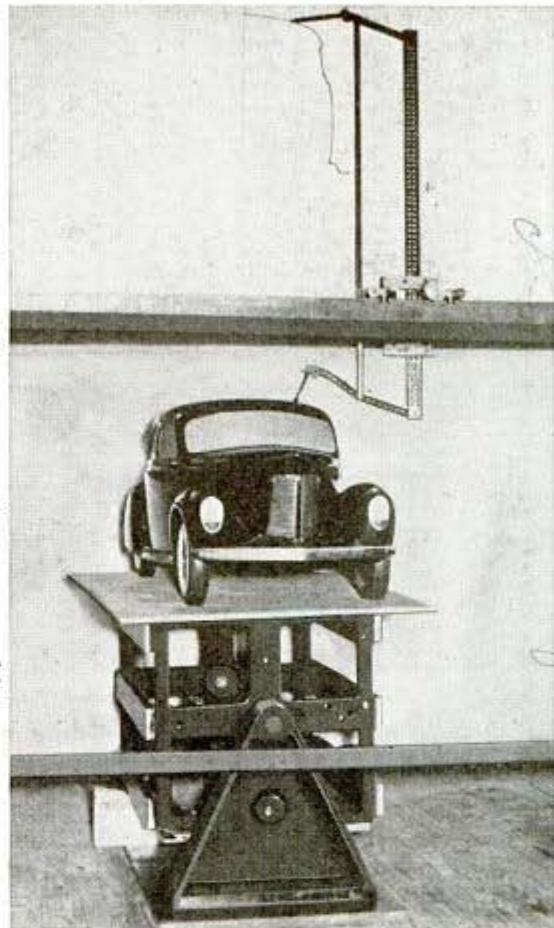

Tracing head, following contour of model, actuates drawing pen, at top, which makes sketch of outline

Draftsmen can save themselves considerable work in sketching the exact contour of a model by means of a traveling tracing tool, working like a pantograph, that draws outlines direct from the actual model. It is mounted on a carriage riding an overhead straight track and consists of two movable arms connected by link assembly, one arm extending below the carriage and acting as a tracing head as it moves over the model, while the other, extending upward, contains a tracing pen or scribe and draws outlines to conform with the motions of the tracing head. The equipment is portable and may be used in drafting rooms and template departments. It is handy also for checking cavities on casting dies.

Look in the index to find where to buy articles described in this magazine. Say You Saw It in Popular Mechanics.

similar - take engineering drawing

M. 15

Helmet Holds Field Glasses Leaving Hands Free



Resting on the platform extending from metal headgear, the field glasses are held steady at eye level

To hold field glasses at eye level while leaving the hands free for other tasks an inventor has brought out a semi-helmet, consisting of metal straps fitting over the head, an extension to support the glasses, and a chin strap. It is adjustable by wing nuts. The inventor believes the mount would be of value in military operations.

M. 28

Man Power of Warring Nations Estimated Near 200,000,000

Based on their man power of military age, the Allied nations outnumber the Axis better than five to one. This is the estimate made by the U. S. Census Bureau, which puts the total of men aged 18 to 35 in the United States, Great Britain and its Dominions, Russia and China at 163,887,000 against a total of 28,560,000 available to Germany, Italy and Japan. These figures did not include the Netherlands Indies, where adequate census records are lacking, but the Indies have a total male and female population of more than 69,000,000. Further, the German-occupied countries stretching from Norway and France to Poland and Greece, and French Indo-China, are omitted from the Axis side of

the balance sheet, and they have a total population of 167,978,000. Males of military age are estimated by the Census Bureau as follows: United States, Philippines and other territories and possessions, 22,-796,000; United Kingdom, 6,815,000; Australia, 1,083,000; Canada, 1,797,000; New Zealand except native Maoris, 238,000; Union of South Africa whites, 340,000; India, 58,244,000; Russia, 23,574,000; China, 49,000,000. Against these are ranged Germany, including Austria and Sudetenland but not other occupied lands, 11,281,000; Italy, 6,440,000; Japan, without Korea and Manchukuo, 10,839,000.

M. 20

Glass Filter for Tobacco Pipe Sweetens and Cools Smoke

Many complaints of pipe smokers are said to be overcome with a glass-fabric filter that fits like a bag inside the bowl. With the filter installed, there is no need for breaking in a new pipe, since the Fiberglass lining acts as a ready-made cake until a sweet, even cake has been formed. It also insulates and cools the bowl. The glass mesh strains the smoke, keeps tobacco particles out of the shank, prevents clogging and reduces the need for using pipe-cleaners and reamers. Like a wick, it carries the harsh and bitter juices to the combustion zone where they burn off, keeping the pipe dry and doing away with tongue bite. It prevents waste by burning the tobacco to a white ash on a cushion of air cells.

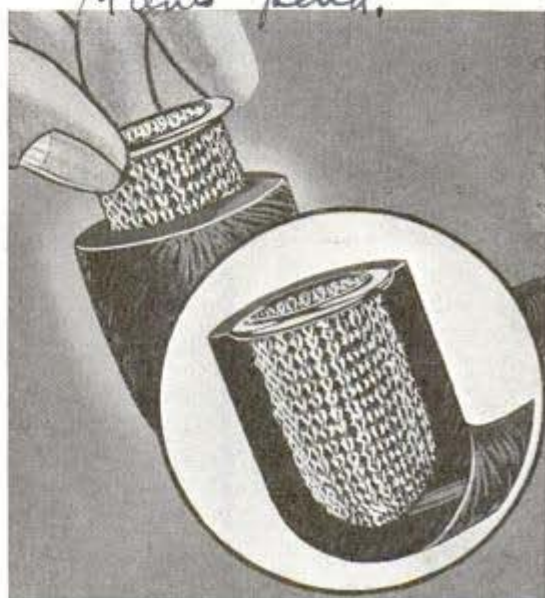

Inserting filter made of glass fabric into bowl of pipe. Sketch in circle shows lining formed by bag

Leonard C. Corcoran, 911 1/2 N. 1st St. N. W. Wash. D. C.

Clad. 2

M. 28

Ground 2, m. a. 2/17/42

Clad. 2

Clad. 2

Clad. 2

Empire State Bldg. New York

W. A. Park Co.

Copyright © 1942 by W. A. Park Co.

785

(K. H. Jackson, supervisor)
Steel metal and arc
weld

Phone System in Helmets Helps Teach Welding



Left, apprentice and instructor using one-way phone; helmets, right, reveal receiver and transmitter

Protection for the arc-welding instructor and greater efficiency in teaching are provided by hooking up a one-way telephone between helmets worn by the teacher and student. Using two ordinary helmets, an instructor at Caterpillar Tractor company of Peoria, Ill., installed a transmitter in the one worn by himself, and a receiver in the one for the apprentice. The outside wires, connected to a wall box

containing four "B" batteries, are strung through ring supports overhead to keep them out of the way. This arrangement permits the teacher to give instructions while the apprentice works, such as telling him to shorten or lengthen his arc or commenting on the rate of travel, all in an ordinary tone quite audible to the student. The instructor often can point out things impossible to illustrate in the classroom.

Allen W. ...
34 3.5 3.5 ...

Extra Tanks of Nazi Planes Resemble Huge Torpedoes

When the British 8th Army captured an airport in the Libyan desert they found a great pile of tanks resembling huge torpedoes. Apparently these were auxiliary fuel tanks brought across the Mediterranean to furnish additional supplies for the German air forces.



British soldier examines the torpedolike fuel tanks captured in desert

Write to the firms listed in the Where-to-Buy-It index, to learn more about products described in this magazine. Say You Saw It in Popular Mechanics.

Leggett
TIPS for TABLE TOPPERS



It has been said that three things make table-top photography an ideal pastime. First, it's a lot of fun; second, it teaches you how to create subjects and exercise your imagination; and, third, it makes you master of lighting effects—the interesting ones—in record time. So let's go table-topping. It has its basis in the little everyday objects of life—the tiny ornaments, the toys—which we often overlook. It took two flood lamps, some pipe cleaners, an alarm clock and a big slice of imagination to create the snapshot at top, right. If you have a little porcelain dragon, you can set it on a table, arrange a few tiny Chinese figures as desired and then shoot something resembling the picture shown below. Its creator used two No. 1 flood lamps—one three feet back and slightly to the right, and above the subject, the second, farther away and behind the camera

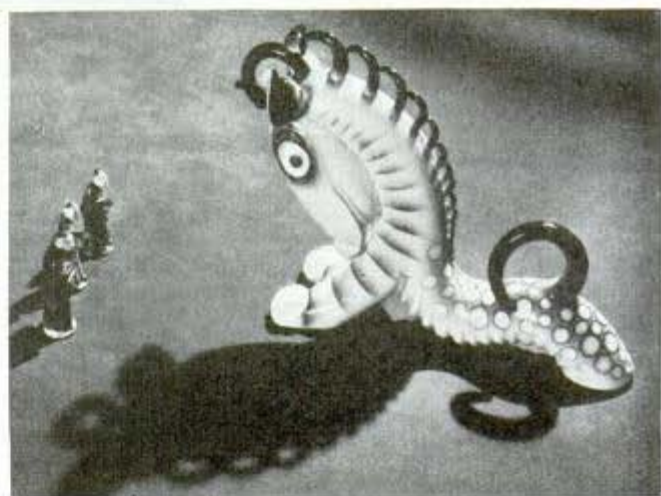

Above are two interesting table-topping photos, the top one illustrating the preparation of a scene, the bottom one showing the resulting picture. The deer is just a porcelain figure, the snow nothing colder than salt shown being applied to create the winter landscape in the photo at top. Of course, much of the punch in table-top photos is supplied by the lighting. It's easy to achieve desirable lighting effects even with simple equipment, because you're working on a small scale. One No. 1 and one No. 2 flood lamps in inexpensive handy reflectors are usually sufficient, but you may find use for a small spotlight if you go table-topping in a big way



This might be labeled "Old Woman Who Lived in a Shoe Had So Many Children—." One secret of the successful table-topper lies in his skillful arrangement of scenes, as demonstrated at left. These and other pictures on these two pages should give you a good idea of what kind of subjects may be used. If you find nothing at home to excite your imagination, a trip to the toy counter of your dime store may prove worth while. That toy counter is not only a source of materials, but ideas as well

At right is something a little different, but merely a football "made up" for a striking photograph. Common objects appear quite different in closeups. As a result, if you like realism in your table-tops, you can achieve the effect of snow by substituting sugar, salt or cotton; of water with a piece of rippled glass, crumpled wrapping material, or a mirror; of a lawn or pasture with a bit of plain, dark carpet; of a tree with a small branch or a few leaves. You can make funny little figures and animals from vegetables, pipe cleaners, bits of cloth and wire, toothpicks and whatnot. From the technical standpoint, you'll do best to use a small lens aperture to obtain all-over sharpness, and to keep the background close to foreground. Furthermore, when working at close range, you should aim the camera lens rather than the viewfinder directly at the subject



7.162

Heaviest Bomb to Fall on Britain Weighs Nearly Two Tons



Giant bomb is probably the heaviest to be released on Britain

One of the heaviest bombs the Nazi air force has used against Britain is a giant, nicknamed "Satan," which failed to explode. It weighs 3,968 pounds, a few pounds less than two tons. The fins of this dud were broken off when it struck, but originally it measured 13 feet 3 inches in length, and 2 feet 3 inches in diameter.

m 38

Ban on Cameras in Civil Planes For Duration of War

Aerial photographs by civilians are forbidden "for the duration" by a War Department order. Passengers on air liners are required to pack their cameras beyond reach or check them with the stewardess, and the ban also extends to crews of the air liners. No civilian can carry a camera in his own plane; even the Civil Air Patrol, composed of civilian pilots operating under army orders, is forbidden to take pictures from the sky. There is but one loophole. A civilian having a highly important reason for taking an aerial photograph can

petition the regional office of the Civil Aeronautics Administration, which must pass the request on to the War and Navy Departments. But permits from Washington are expected to be rare.

m 83

Air Cleaner Deodorizes 100 Cubic Feet a Minute

Working on the principle of a gas mask, an electrically operated "adsorber" purifies kitchen air at the rate of 100 cubic feet per minute. It removes cooking odors so quickly that onions and other odorous dishes may be prepared without fear of offending the most discriminating guest. In the purification process, air is drawn by a fan through a filter and then through tiny grains of carbon produced from coconut shells. The surface of each grain consists of countless microscopic canals or capillaries which adsorb impurities such as condensable gases and vapors which carry the odors. When the carbon becomes saturated with impurities it may be reactivated and used many times over. This is the same process used in military gas masks. The adsorber is housed in a streamline container 24 inches long. A 40-watt motor turns the fan.



"Adsorber" operates like gas mask in deodorizing air

m.127 The Pacific Lumber Co.

Fiber From Redwood Bark Is Wool Substitute

Now they're harvesting wool for clothing from the bark of California's giant redwood trees, oldest living things on earth. Until a decade ago this bark, which grows up to ten inches thick, was a waste product. Then research men of the Pacific Lumber company discovered the bark fibers had valuable insulating properties; they were long-lived, resisted fire and moisture, and were distasteful to vermin and insects. Redwood wool insulates cold storage and meat packing plants, quick-freeze food warehouses and the walls and ceilings of homes. The latest development is its use in textiles. Combined with natural sheep wool, the bark fibers form a strong fabric, useful in felt hats, lightweight blankets and clothing. The combinations range from 15 to 60 percent of bark fiber in the finished products.



Patco insulation

100% Bark. It's our fiber wool.

Fibre a.



↑ Here is a jacket made partly of fibers from redwood bark. In her hands the young lady holds redwood wool sample

← Stripping the bark from a giant redwood log. It is shredded and processed into textile fibers and wool for insulation

New War Tools Are Built From Old by Yankee Ingenuity

Changing over industrial plants from peace to war production has been speeded up mightily by Yankee ingenuity in improvising tools for the new purposes rather than waiting for specially built machinery. One factory, for example, switched production from electric fans and motors to gun turrets and shell boosters. It would have taken two months to get a new machine to burr holes inside the shell boosters, but in 30 hours the engineers rigged up a homemade machine to do the job—

making use of a dentist's burr. It took them 60 hours to build a machine that would ream two holes simultaneously. The superintendent used a fan base and a couple of pieces of machine tool to contrive a machine that would check the accuracy of threads on the shell boosters. An old standard arbor press was converted into an air-operated machine to stake screws in the shell boosters, and a girl who formerly worked on a machine making loose-leaf notebook binders is operating it.

Science Service

BILLIONS WAITING to be TAKEN

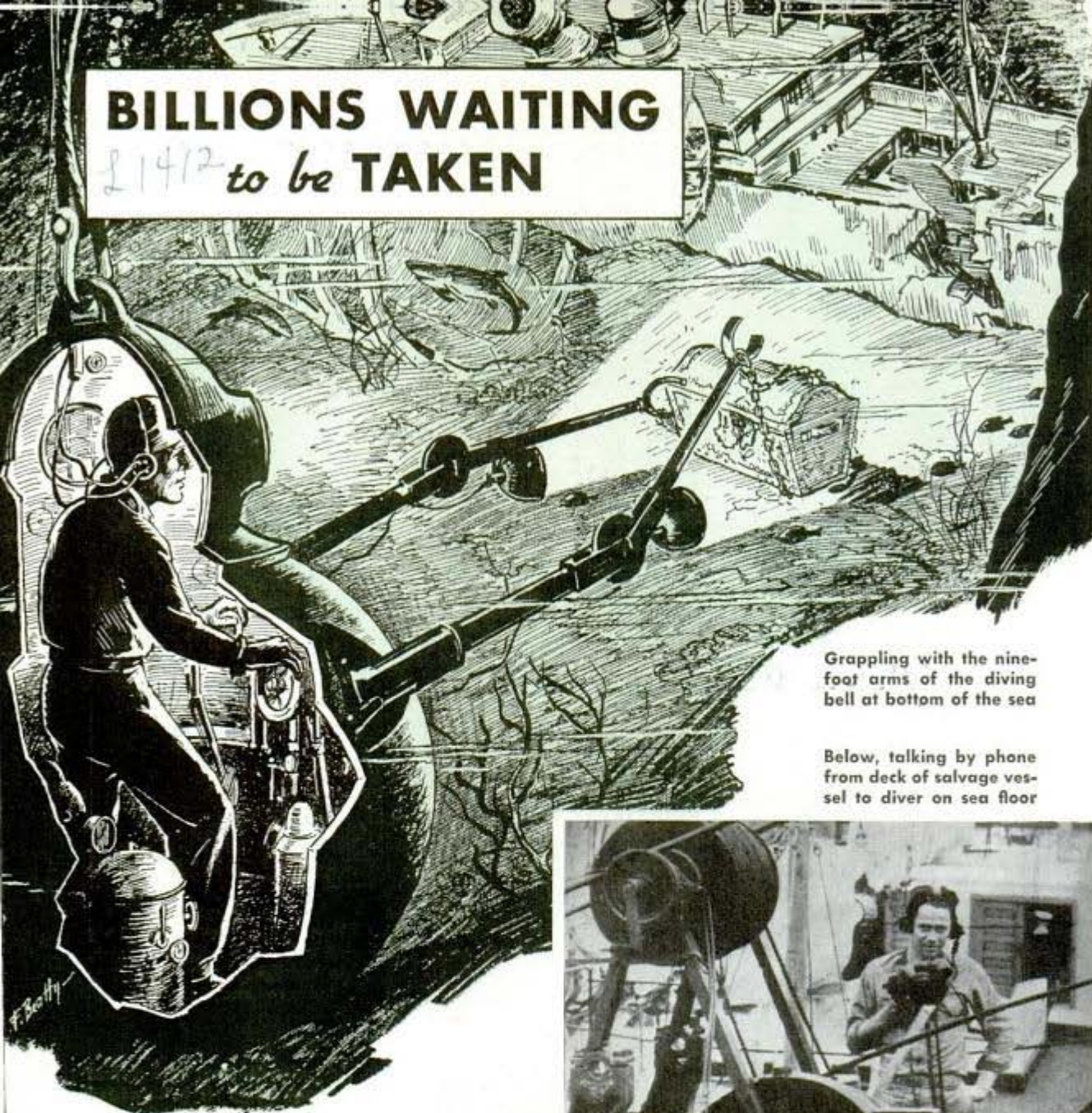

Grappling with the nine-foot arms of the diving bell at bottom of the sea

Below, talking by phone from deck of salvage vessel to diver on sea floor



By Lieut. Harry E. Rieseberg

Noted deep sea explorer and salvage expert, and author of "I Hunt Treasure," (Robert H. McBride Co., publishers) from which this story has been condensed

SOME DAY, when peace returns to the oceans, we'll start prying open Davy Jones's locker to wrest from it the fabulous treasure sealed there under shifting sands and barnacles, guarded by treacherous deep-sea fish and octopus and the enormous pressure of the depths.

Billions lie there awaiting the challenge of brave and resourceful men; billions in pirate gold and merchant cargo lost in storm and battle. Since 1500, one-eighth of all the gold and silver mined by men

has been sunk to the ocean's bottom. A former chief of the Navy hydrographic office reported that in 1893 "reliable statistics show an average annual loss of 2,172 ships in the commerce of the world." Multiply that by 100 and the total of ships sunk in the 19th century alone is staggering.

Twenty-five million tons of shipping went down in World War I, and the toll in the present war will be even more disastrous. But the public fancy turns most often to those argosies of the 16th, 17th and

P.O. Box 312
Canaia Pk., Calif.

see August 1934
212.

L7412



18th centuries that loaded gold and silver and gems in the new world for Spain and Portugal, only to founder or be looted by pirates in the Caribbean.

Some economists estimate the world's drowned treasure at \$3,000,000,000, and this takes in only such wealth as gold and silver, jewels and ornaments. In merchant cargo and ships themselves the value would be far higher. According to authentic records of the 16th century, the Portuguese and Spanish alone were relieved of more than \$250,000,000 in treasure. The first major catastrophe of that century was suffered by Spain in 1502. Three years before, Francisco de Bobadilla had been appointed Governor of all Hispaniola by King Ferdinand and Queen Isabella. Bobadilla had come from Spain with this commission, and, jealous of Christopher Columbus, soon trumped up a charge against him. Columbus was chained and sent back to Madrid to be tried for disloyalty.

With Columbus out of the way, Bobadilla began gathering for himself a fortune in gold and silver and ordered his henchmen to stop at no means in forcing the Indian and

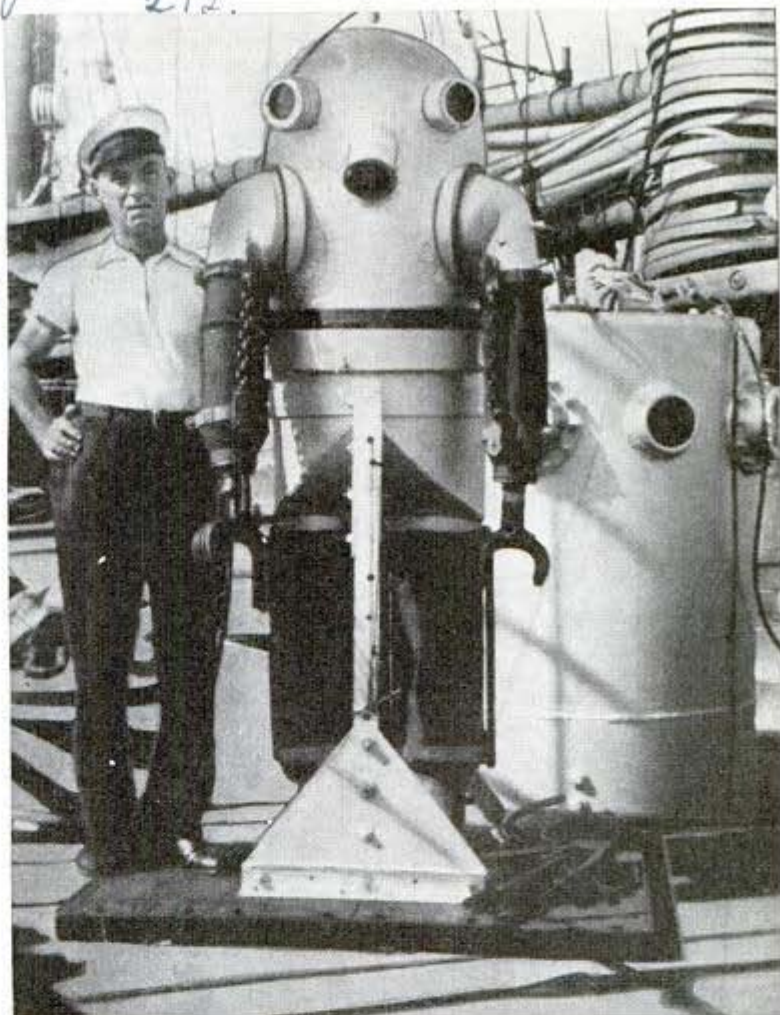

© Lieut. H. E. Rieseberg

Weird and clumsy "iron man" is safe for descents of 1,000 to 1,500 feet
Clad in heavy wool clothing, Lieutenant Rieseberg enters the diving bell



21412



These are 17th century diving bells; in the one below fresh air is being siphoned into open-bottom bell from lowered barrel



Negro slaves to produce the coveted metals. The fiendish methods adopted have made an eternal black mark in history. Three years later Bobadilla stowed his tremendous accumulation of gold and silver aboard his flagship, the "Golden Hinde," and all was in readiness to sail for Spain when into Santo Domingo harbor sailed the lead ship of an inward bound fleet. Christopher Columbus, no longer in chains, was aboard! Columbus sent word to the flagship that bad weather was imminent, but Bobadilla scoffed at the warning, and his "Golden Hinde" swept out of the harbor July 4, 1502.

The "Golden Hinde" never reached Spain. A hurricane swept across the Caribbean, and the galleon plunged to her doom near Cape Engano, Haiti. There she lies, weighted down with more than \$5,000,000 in golden ingots and silver plate, awaiting some lucky salvor.

The Portuguese suffered even greater losses in that century. Dutch privateers plundered the Portuguese galleons laden with gold from Brazilian placer mines. The Portuguese scuttled their craft rather than lose the treasure to the Dutch and today, the shoreline of Brazil is marked with the hulks of those treasure-laden ships.

In the 17th century, one of Spain's greatest losses was the \$21,000,000 Silver Shoals treasure; another was the destruction of a fleet of galleons laden with \$30,000,000 treasure by the Dutch Admiral Pietr Heyn, off the coast of Cuba.

The Silver Shoals loss was due to shipwreck on those treacherous reefs in 1643. In 1687, a New England skipper recovered some \$1,500,000—from one of the rotting hulks. The balance is unsalvaged.

In 1628, Admiral Heyn received word that a Spanish fleet was about to sail homeward. Heyn slipped into a Cuban bay and waited. On September 8 he sighted the flotilla and saluted it with a devastating broadside and

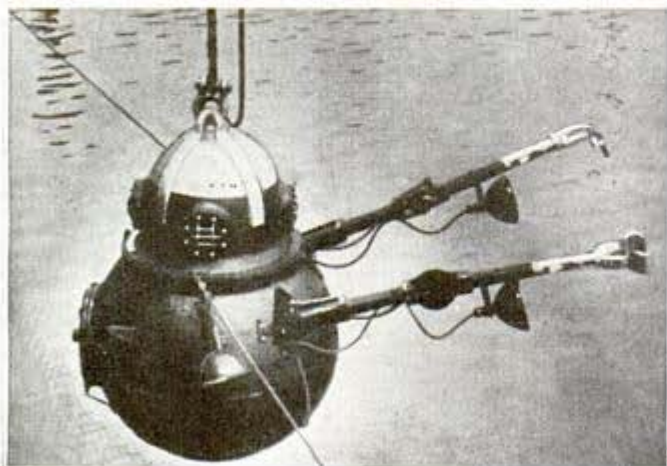
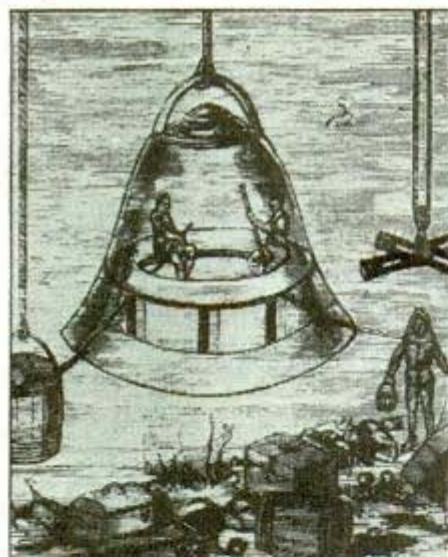

← Modern deep-sea robot is lowered away



© Lieut. H. E. Rieseberg
Stars mark major treasure caches on Caribbean map

In the diving suit is the author, internationally known salvage expert and authority on ocean treasure

chased four galleons and eleven other craft into the shelter of Matanzas Bay, where the Spanish hoped to land the treasure and hide it in the jungle. There was no time. The Dutch frigates were coming. Frantically the Spaniards heaved the precious cargo into the waters of Matanzas Bay, set fire to their galleons—and consigned \$30,000,000 to the sea. It's still there.

For sheer bulk of treasure no story can compete with the disaster that overtook the Spanish at Vigo Bay in 1702. It concerns 17 galleons packed with \$140,000,000—the greatest plate fleet in history! As France and Spain were allied, a French escort was dispatched to bring to Europe the treasure galleons. There were 40 ships in the fleet—17 galleons and 23 French warships.

When the news reached England, Queen Anne dispatched 27 frigates to head off the galleons. The Spaniards and French ran for Vigo Bay, on the northwest coast of Spain. They arrived ahead of the British, threw a boom of chains and topmasts across the harbor mouth and took every

(Continued to page 178)



Opaque Shade for Blackout Stops Leakage of Light



Blackout shade fits snugly so light cannot escape

Blackout roller shades designed for home use operate in the normal way and do not interfere with shades already in place. "Hold-down" brackets keep the drawn shade tightly pressed against the sides and sill of the window frame, preventing light from seeping outdoors. Made of heavy, washable, opaque material, the shades are available in 36-by-84 inch size, 42-by-92 and 42-by-96.

Corkscrew Combined With Puller Removes Cork Gently

Only slight physical effort is needed in pulling tight-set corks with a corkscrew built into a wooden screw-type puller. In

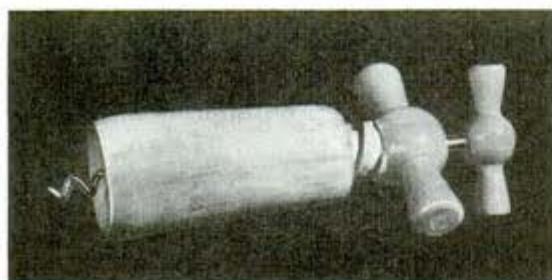

Cork puller lifts corks gradually and without jerk

operation, the corkscrew is turned into the cork its full length in the usual manner. Then the second handle is turned in the same direction until the wooden shell bears against the top of the bottle. A few more easy turns will exert an upward pull upon the cork, bringing it out unbroken.

Fireproof, Rot-Resistant Wood Replaces Steel and Concrete

Lumber impregnated with chemical salts to preserve it against decay is taking the place of steel and concrete as a building material. "Preserved" wood has long been used by railroads for bridge timbers and ties, and now that steel is in demand for war purposes, treated wood is finding far wider uses. It is termite repellent, clean, odorless and easily painted. One preservative, chromated zinc chloride, also gives wood substantial resistance to fire.

Dispensing Cup on Bottle Top Pours Amount Desired

Liquids can be served in controlled amounts from a bottle fitted with a dispenser which permits you to see the portion before emptying it into a glass. If too



Pressing plunger releases liquid from the dispenser

much flows into the dispenser it may be poured back into the bottle and remeasured. A thumb lever lifts a plunger to release the liquid from the dispenser. This action also seals the bottle so no more liquid can be poured in one serving than had been permitted to enter the cup. Fitting most bottles by means of a rubber collar, the dispenser quickly serves fruit juices, salad dressings and other liquids without risk of an overdose.

Branding Iron and Lug Locks Foil Tire Thief

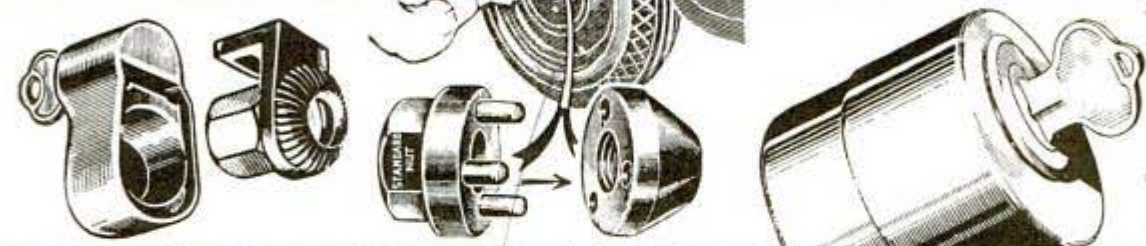
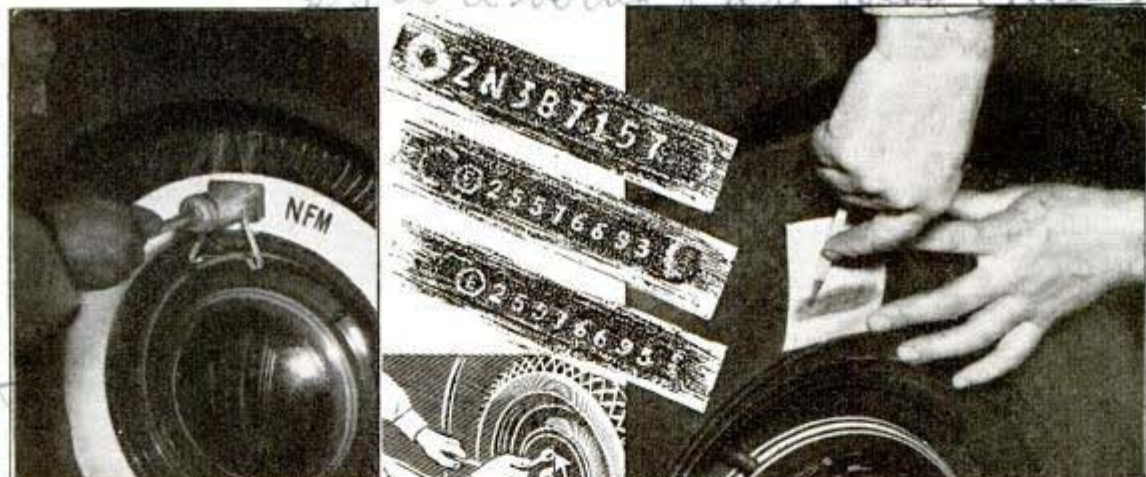

Left, top and bottom, tire is branded with initials and license number. At top, center and right, serial number of tire is traced with pencil and filed for identification. Other pictures show various lug locks

With tires now in the category of precious possessions, motorists are taking new precautions to prevent theft and to recover tires that are stolen. A record of serial numbers is essential for the identification of stolen tires, and this can be obtained easily, even if the numbers are on the inner side of the tire, by laying a sheet of paper over them and rubbing a pencil or crayon over the paper until the numbers are transferred in clear relief. Your initials or license number can be branded on each tire with an electric branding iron without damaging the casing. This service is offered by some rubber companies and ga-

rages. Another method of foiling the tire thief is to install one of the several types of lug nut locks that are available. Fastened tightly over at least one lug on each wheel, these locks make it impossible to remove the lug without first forcing the lock, which is a tough job and difficult to achieve without attracting attention. The lock weighs four to eight ounces, and should be counterbalanced by a mechanic to keep the wheel in proper balance for maximum driving ease and tire mileage.

☐ To learn where to buy commercial products described in these pages, see the index.

Cont. Van Wagon, No. 29 Hunt Ave. Chicago
 Chicago, Ill. 1942
 Certified Standard, Inc. 1421 N. Michigan, Chicago, Ill.

In 1943 Electric Branding Device - Great Lakes Stamp Co. 500 d. room, Park Island, Chicago, Ill.

HOW to OUTSMART the FISH

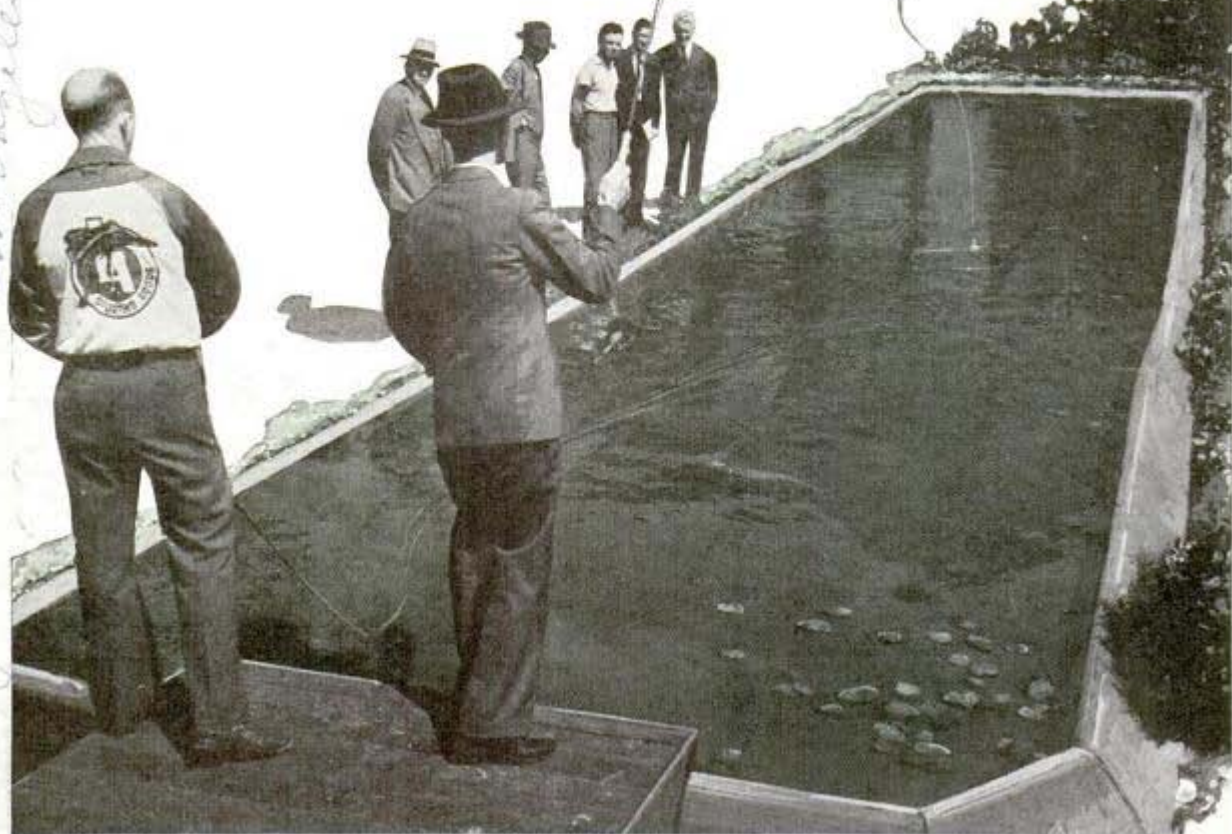

Fly fishermen, practicing for accuracy, try to drop fly within wooden ring floating on the water

Photos Automobile Club of Southern California

Taking water temperature. The colder it is, the more fish hug the bottom and must be fished for deeply

By **C. B. Harrison**

Fishing Expert, Automobile Club of Southern California

NINETY percent of the people who go fishing don't know how to fish. They go where there are no fish, or scare them away, or fish improperly. If you follow a few simple rules, you'll catch fish and have fun besides.

First of all, don't be too proud to ask questions. Resort owners and the hardware and tackle-store men know where the fish are and what sort of lures they are taking. Ask them.

Some spots in every stream and lake are better than others. Often the best way to fish one lake is a poor way to fish another. There's



2002
 3872 Franklin Ave
 Los Angeles
 2601 S. Figueroa, Los Angeles
 C. B. Harrison &

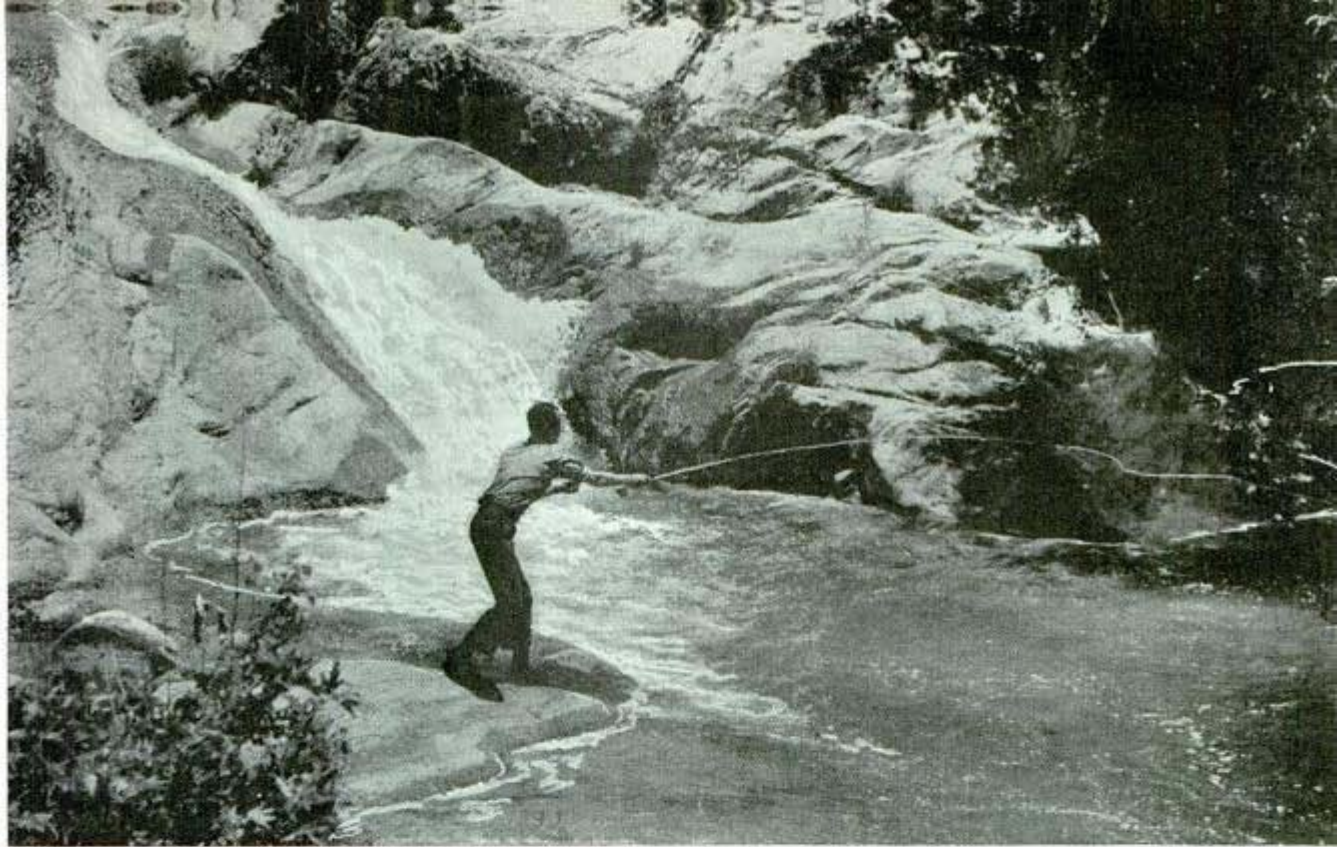

2993

Fast water like this is the place to fish for the hard-hitting trout

Various plugs and lures. Curved plug at right attracts by churning water

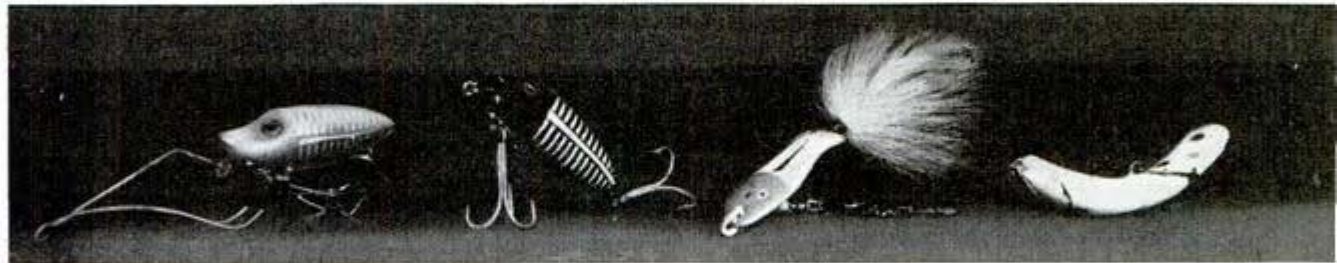

one chain of three lakes, almost side by side and fed by the same stream, that takes bait fishing in the upper lake, fly casting in the middle lake, and deep trolling in the third for best results. Different water conditions and feed account for this. If you can't find fish in a strange lake by looking for them, trolling will often reveal the best spots.

Bass, trout, crappie, perch, catfish and bluegill and other sunfish are the most popular fresh water fish. Most of them can be caught on either bait, spinners, flies, or plugs, and there is a time and place for each of these lures. When you are away from home it's smart to buy baits and lures locally from people who know what the fish are taking.

Fish bite whenever they are hungry and they are least active in the middle of the day. That's about all you need to remem-

ber. There are a lot of rules to the effect that fish won't bite during or after thunderstorms or on windy days or on a falling barometer but all these rules fail. You are apt to catch fish any time so the time to go fishing is whenever you feel like it. Not everyone will agree with me about this but such arguments are among the things that make fishing interesting.

A good fisherman makes a careful, quiet approach to the spot that he hopes to fish. He watches for fish and tries to see on what they are feeding. If none are active he looks for them among the rocks and among grass and branches. Generally he uses a bait or spinner early in the season and changes to a fly when warm weather heats the water and brings the fish up to the surface. Bugs and flies hatch out on the surface of the water in warm weather and the fish rise to this feed.

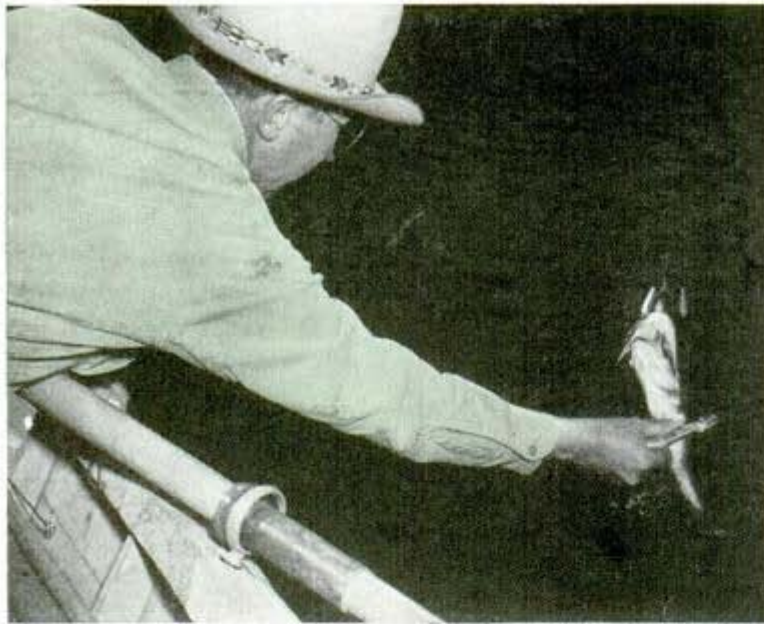

Clawlike mechanical holder is being used here instead of landing net to take the catch. Be sure to take one of them when you go fishing

The good fisherman uses the lightest leader and smallest hook that are practical because they will catch more fish than heavy equipment that the fish may see. He remembers that fish are timid. Vibrations caused when you stumble over a rock or when you row a boat carelessly will scare fish away. Chunking a bait or fly into the water with a splash will frighten them. So does your shadow on the water, or active movements if you are standing against the sky. Try to stand with your back to the sun, far enough back from the water so that your shadow is on the bank. If you can stay hidden behind a rock or tree there's not a chance for the fish to see you.

The man who wades or works upstream, throwing his lure ahead of him and letting it drift back, usually catches more fish than the man who works downstream. This is because fish normally keep their heads pointed upstream into the current and are less apt to see a fisherman approaching from behind.

Seventy percent of the fish that are caught are taken on bait, either natural or artificial. If you carry worms on

Quiet and caution, fishing still waters in weeds and rushes, help in catching fish

the trip, don't drown them with water. Damp earth is better for them than moist earth. And don't keep them on the floor of the car right above the exhaust pipe. Too much heat will kill them.

If you are using bait in a stream, let the current drift it along just as if it were another piece of debris or food on its way downstream. Fishing with bait in a lake, let the bait lie on the bottom if the bottom is sandy. On a mossy bottom the bait must be held a few inches above the moss so that fish can see it. If the bottom is weedy the bait must rest higher still, being held in

place with a float. Bait fishing requires patience and you will catch few fish if you jerk the hook every time you feel a nibble. Unless you are working in a fast stream you must let the fish take the bait and start away with it before you set the hook.

Good fly casting is an art and the best way to learn it is to ask a good fly fisherman to teach you. He will be able to get 50 or 60 feet of line out and then drop the fly gently on the water. Half that amount of line will catch a lot of fish if you don't slap the water with the fly, so forget about trying to make long distance casts until you learn to make good short ones. A



2993

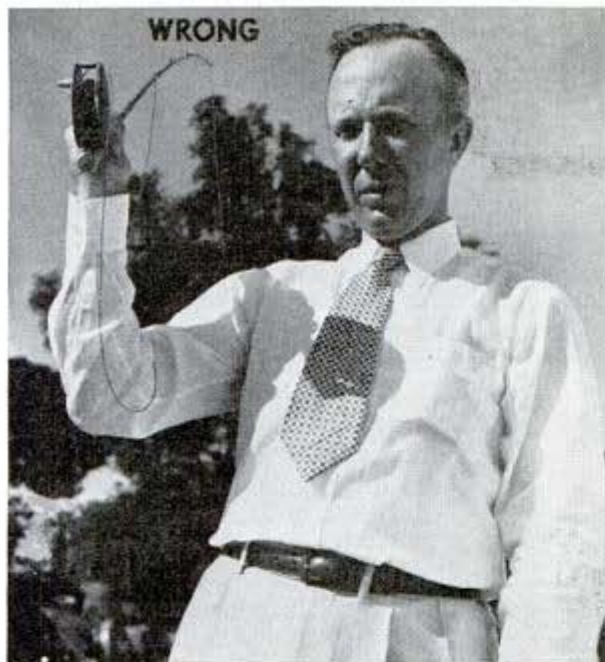

Raising upper arm, moving arm away from body and flipping rod too far back are three mistakes commonly made in fly casting

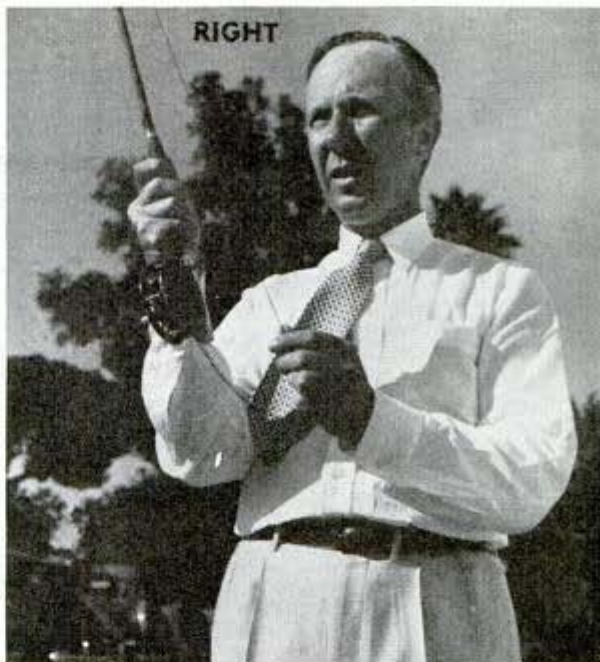

In contrast, note this position, which is top of back cast. Wait a second, then shoot line forward with short snap of the wrist

cheap rod is not much good for fly casting.

Forget that you have a shoulder and an upper arm in making casts and use only the forearm and wrist. Toss the line up behind you with a short sharp flick of the wrist, wait a second for it to begin to straighten out, and bring it ahead again with a forward wrist motion. A good fly caster puts a little "kick" in the forward motion that lays the line out straight and drops the fly gently. Don't try to control the line; learn to control the rod and it will control the line. After you have learned the fundamentals you can practice casting on your lawn.

Fish that take a fly usually hit it hard and fast so always watch the fly when it is on the water. Hit back instantly but not too hard the instant you see a fish hit. Sometimes when fish won't rise to a fly you can get action by hooking a short length of worm to the barb and letting it stream out behind the fly.

Big fish like deep water and they like to hide beneath undercut stream banks. From a lake bank, toss your lure out past the drop-off

to reach the edge of deep water. On a stream, throw the lure so the current will drift it down toward the undercut bank.

There are literally hundreds of artificial lures on the market. Some of them resemble natural baits and some of them look like nothing on earth. Most of them do a



Fish holder built like elongated landing net attached to side of boat for keeping captured fish alive

2093

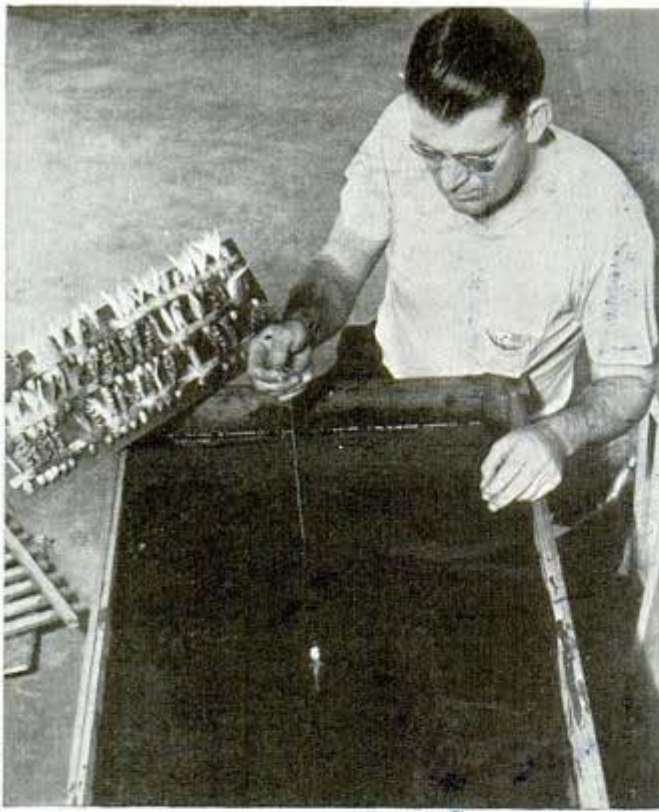

Trying out the "action" of a wobbling bass plug in test tank. Anglers should know how each lure and plug works in water. Angler in swordfishing cap which keeps sun off his face is shown selecting a rubber crawfish to be used as bass lure



good job but you should use local advice in making a selection. One of the best varieties of these lures is the so-called flat fish of different sizes. These are light wooden plugs that are carved on a curve, the effect of this being that they set up a violent action when being retrieved through the water.

You can spend \$100 on a fishing outfit or you may buy everything you need for less than \$10. A complete and inexpensive outfit, including collapsible steel fly and bait rod, oil finished fly line, bait line, two different reels, tackle box, and assorted equipment, came to exactly \$8 at one store. The steel rod is not much good for fly casting but it is ideal for brushy streams. Although cheap, the outfit will catch a lot of fish. Included in the equipment are leader gut, worms, flies, plugs, salmon eggs, and a landing net. Don't forget the last item. Most fish that get away are lost when they are being taken from the water. I lost eight fish in a row one morning because I had forgotten to take a landing net with me.

Most people troll too fast for best results and most people retrieve spinners and flies too fast. Go slow and catch more fish. If you catch a fish that is under the legal size, wet your hand in the water before touching the fish. Remove the hook gently.

Just like any other sport, practice and experience will make you a better fisherman. The man who sells you equipment can show you how to tie lines and can give you other tips because he is probably a fisherman too. Finally, watch the men who are catching fish and learn from them.

At least, that will save you from the plight of a vacationist who bought a fishing outfit, rented a boat and went fishing. He came in hours later, disgusted because he hadn't had a strike although everyone else was catching fish. Then someone noticed that he had forgotten to attach a hook to the big spinner he was using.

M 126

Dr. Col. Gustave West
34th Armored
Crewmen

Rocking Gun-Mount Trains Tank Marksman

Rocking, lurching movements of a tank over rough ground are simulated by a stationary gun mount devised by a Fort Knox officer for use in training gunners to fire accurately from moving tanks. Mounted on a post through a universal joint, a wooden 37-millimeter tank gun is aimed by means of a regulation gun sight. In order to check the gunner's accuracy, a repeating BB gun is attached to the dummy. While the gunner attempts to hold the gun on a fixed target as he would from within a tank, another person wobbles the platform vigorously.

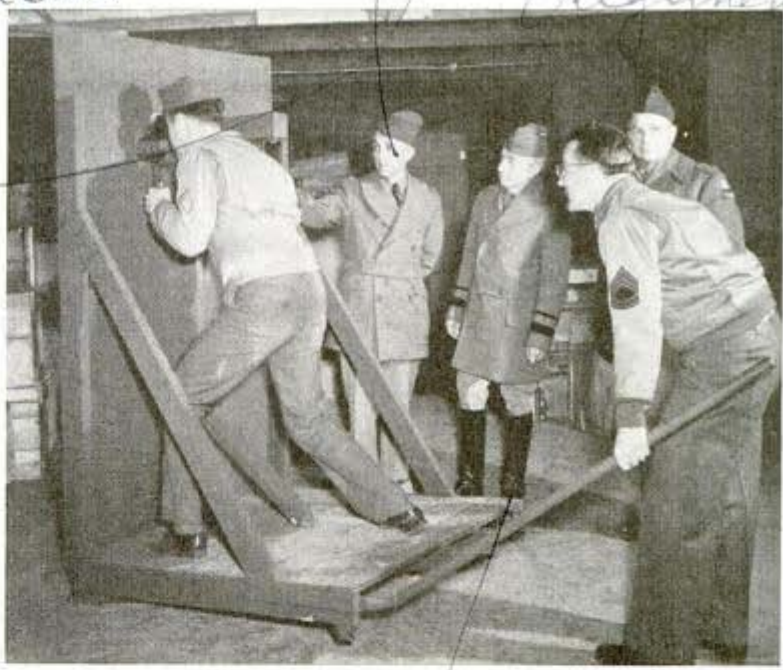

One man rocks platform while another fires at target as from moving tank.

Carl John McHardaway

M 43

Brig. Gen. Jack W. Heard

Changeable Flashlight Lenses Shine, Red, White or Blue

Safe Delay Switch Corp., 540 Lake Shore Drive, Chicago.

interchangeable colored lenses of unbreakable, translucent plastic. A lens is mounted over the bulb by its two tabs which fit into slots on the face of the flashlight. The red lens is used as a danger signal, the white

lenses for ordinary uses, and the blue lens gives a subdued glow suitable during blackouts. The flashlight may be carried by its heavy wire handle, hung on a hook, belt or coat button, or set up in easel style using the handle as a back support. With the lens removed the protruding bulb supplies a candle light as there is no reflector.

The Martin Co. 1498 Broadway, New York

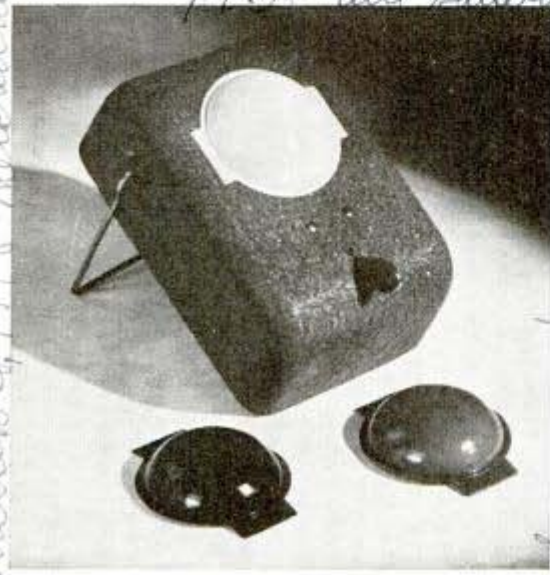

White plastic lens shown in flashlight may be interchanged with the red and blue ones in the foreground

Ice Hotter Than Boiling Water Made by Heavy Pressure

Pressure plays strange tricks with water. Dr. P. W. Bridgman, Harvard scientist, has produced ice at a temperature of 375 degrees Fahrenheit—163 degrees above the normal boiling point of water—under the tremendous pressure of 40,000 atmospheres. This hot ice has a smaller volume than ordinary ice, and sinks in water. Laboratory scientists have recently succeeded in producing pressures of 400,000 atmospheres, or 6,000,000 pounds per square inch. This is the equivalent of the pressure under a tower of bricks 1,500 miles high, or at a point 1,000 miles deep in the earth.

To learn where to buy commercial products described in these pages, see the index.

21405 (Leggett)

"TRACER BULLETS" of SCIENCE

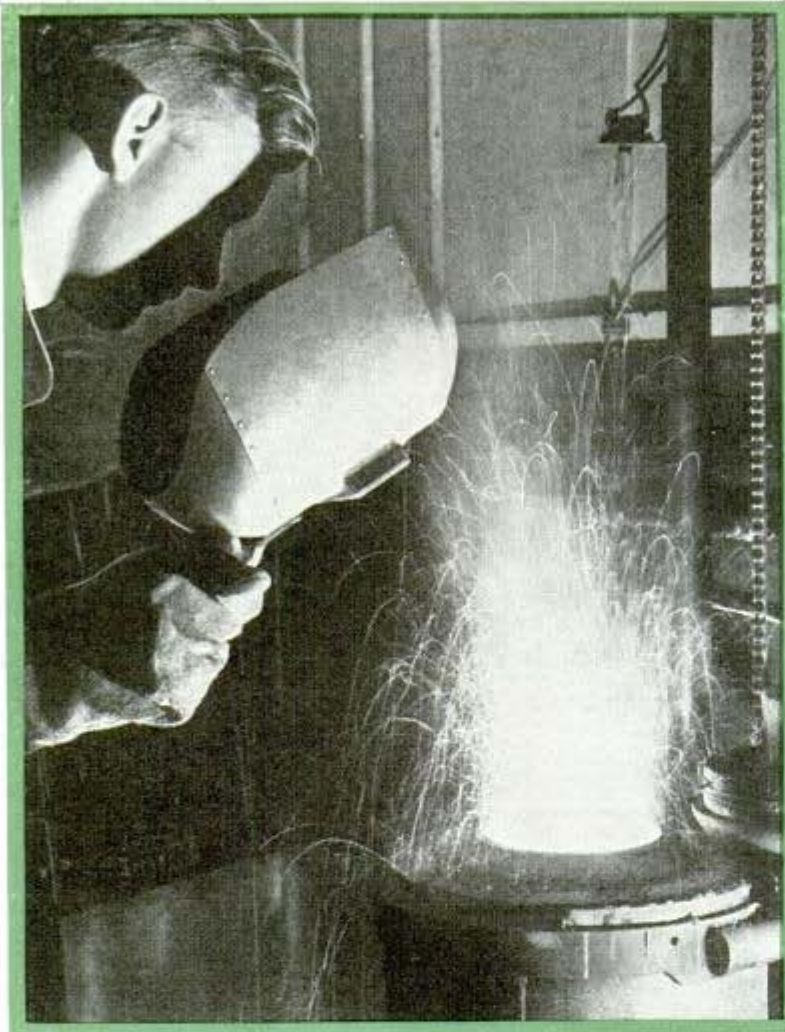

instrument. The tagged atoms mingle with others of their kind and follow them around. Like "fifth columnists," they broadcast their position to this instrument, enabling the scientist to follow the path and discover how normal atoms behave and where they go. In the laboratories we have had a group of physicists engaged in exploring the uses of these newer discoveries during the past five years. This article gives a brief account of some of their results.

In making steel, the phosphorus which is present in all iron ores

Small electric furnace in
← which metallic alloys
containing radioactive
atoms are prepared

Dr. F. W. Stallman pre-
pares to measure thick-
ness of layer of oil on
plate beneath his hand
↓

By Dr. E. U. Condon

Associate Director
Westinghouse Research Laboratories

E. P. Allsbaugh Pa.

LIKE the "tracer" bullets that blaze a fiery path to the target and help the machine gunner improve his accuracy are the "tagged" atoms which modern scientists can follow through industrial and biological processes and learn more about metals, chemicals and the human body.

Tagged atoms are minute particles of matter that have been made unstable by bombardment in an atom smasher, such as the Westinghouse 90-ton electrostatic generator. Thus treated, the atoms are said to be artificially radioactive, sending out radiations similar to those from radium which may be picked up and recorded by a special



21405

Dr. J. A. Hipple at the control panel of his "atom sorter" that sorts atoms by weight accurately

must be removed by heating the molten ingredients of steel in a furnace. This is important since only a small amount of phosphorus makes steel brittle. Into a test batch of raw steel in the laboratory is put a small amount of radioactive phosphorus. As the steel cooks, a sample is drawn off every hour and tested with this special atom-detective, a Geiger counter, to determine the amount of radioactive phosphorus that remains. When the tagged atoms of phosphorus are entirely burned out of the steel, we know the normal phosphorus has been removed also.

Suitable equipment for sensitive detection of radioactive atoms has been developed by Dr. W. E. Shoupp and its application to analysis of phosphorus in steel was started by Dr. J. E. Hill.

This is a new method, which if substitut-

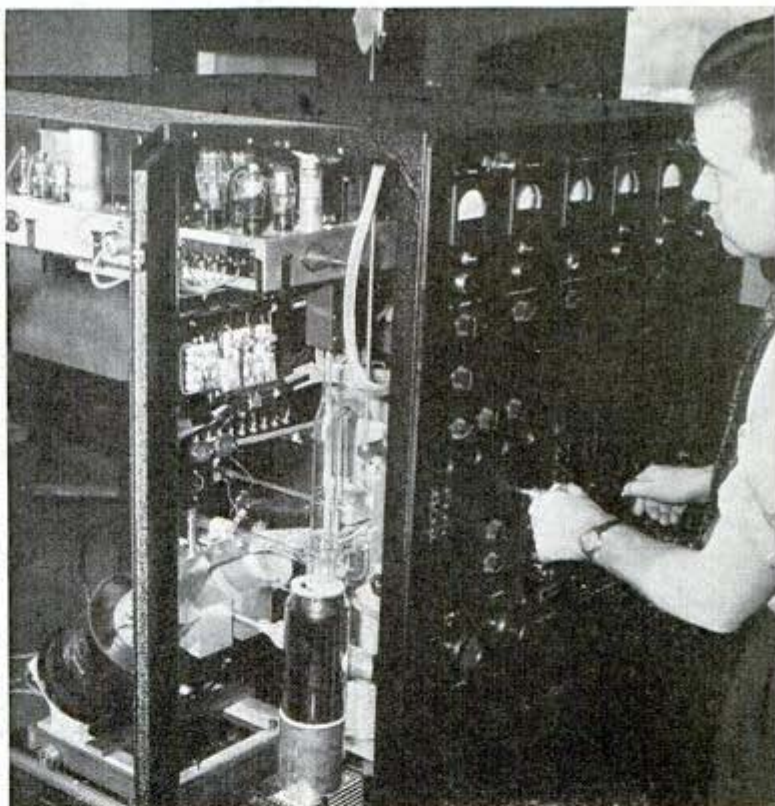

ed for the chemical analysis now used in steel mills, could speed up the measurement of phosphorus in steel 700 to 1,000 percent. It would provide a precise control and prevent occasional "over-cooking."

(Continued to page 170)

Device for "looking" into steel. Disk to be photographed is clamped between film and brass plates

Radioactive disk of gold (held in tweezers) to be dropped into hole in brass block for counting of atoms

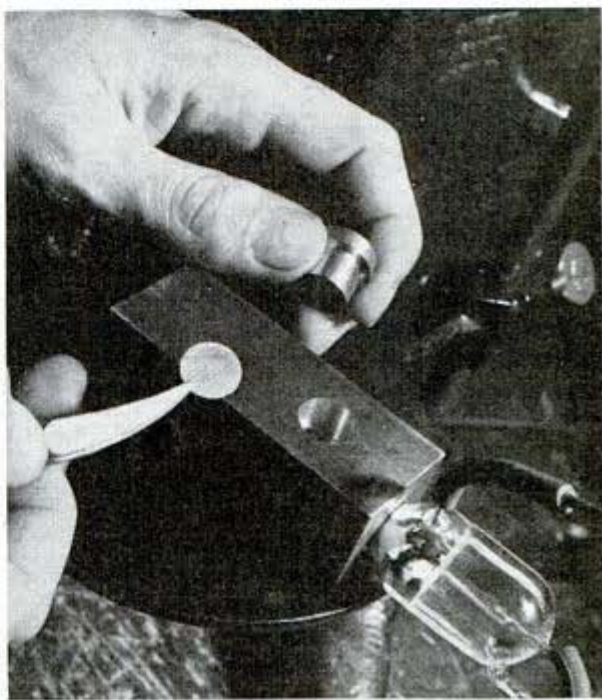

Binoculars Can Be Folded To Fit Pocket or Purse



Binoculars opened for use, and folded for carrying

Having the appearance of a cigarette case when closed, small-size binoculars now on the market may be carried in the vest pocket or purse. They are said to be powerful enough for ordinary uses such as watching sports events. The hinged metal case is opened partly when the objective lenses are raised into viewing position.

Torque Indicates Engine Output Better Than Horsepower

Horsepower has been described as a fictitious measure for an automobile engine's performance. David A. Wallace, President of the Chrysler Sales Division, says that engine torque better represents the rating of engine output, and prophesies that the latter term will be more generally used when normal passenger car production is resumed. Horsepower, when used in connection with a steam engine, describes the amount of stored-up energy available at any moment by barely opening the throttle, but an automobile engine must be running to produce power, and you have to increase its speed to get more horsepower.

Automobile owners are interested in the power delivered to the driving wheels, which is torque—the twisting effort that is converted into driving motion. The ratios of the two do not vary alike with respect to the engine's speed. Here is how they rise with the revolutions of a standard 120-horsepower engine: At 400 r.p.m., 152 foot pounds of torque are developed, and the horsepower is only 14; at 800 r.p.m., the torque is 178 foot pounds, with 27 horsepower; 1,200 r.p.m. gives 188 foot pounds and 42 horsepower; turning the engine at 1,600 r.p.m., you get 189 foot pounds—only one more than at 1,200—although the horsepower is now 58. Torque reaches a maximum at approximately 1,600 r.p.m., and remains about the same for another 1,000 r.p.m. or so, after which it begins to diminish. Friction increases as speed goes up and causes lessening of the amount of torque an engine can deliver.

Wire Brush in Mechanical Drill Cleans Metal for Riveting

Metal-to-metal contact is essential where rivets are used in airplane construction in order to prevent radio interference and avoid the presence of fire hazards. Since internal and external metal parts of a plane are coated with zinc chromate paint for protection against the elements, this paint must be scraped off wherever the rivets and bolts will touch the metal. A little wire brush, mounted on a mechanical revolving tool, is now being used to clean the area around the holes. It works about 700 percent faster than former methods, releasing six men for other duties.

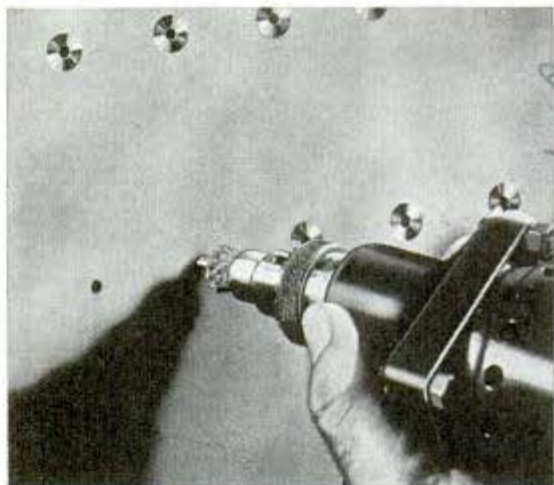

Spinning brush cleans metal around hole for rivet

m 9 / Pittsburgh Plate Glass 2222 errand Bl... Pittsburgh Pa

Movable Glass Walls Stop Chill Wind on Beach



Sun bathers on beach are protected from chill winds by wood-framed glass panes, easily moved if wind shifts

Large panes of glass set in wooden frames, serving as windbreaks on the beach, enable bathers to enjoy the sunshine while protected from chilly winds

and windblown sands. Broad enough to accommodate several people, two transparent walls are joined at right angle, and may be moved should the wind shift.

m 53

Blackout Bulb Sheds Downward Beam of Soft Blue Light

Silvered inside to provide a downward beam that cannot be seen from outdoors, a new blackout bulb offers soft illumination for the home during air raids. The 25-watt bulb is covered with a black silicate coating to prevent light leaks, and its tip is dark blue, shedding a blue light.



Black-coated bulb sends a soft blue beam downward

m 118

Truck Gardener Fools Rhubarb Into Growing Extra Crop

Market gardeners around St. Paul, Minn., have kept up production through the winter by "fooling" rhubarb into growing an extra crop. During October they dug up the roots and soil in which they were embedded and transferred them to sheds to be frozen. This gave them the accustomed rest of winter, and when steam heat was turned on about Dec. 1 and at intervals from then on in the several sheds, the rhubarb awakened into growth. One winter rhubarb grower produced 40 tons, and the total of several market gardeners was about 100 tons, \$125,000 worth.

Wabash Appliance Corp. 235 Carroll St. Plymouth, Mich.

from clubmate mail Harvested in Louisiana



L1033

The RACE of the "IRONING BOARDS"



Plan # 701

ROUGHEST and toughest race in the world—that's what they call the event which has been staged each year between the isthmus of Santa Catalina Island and Hermosa Beach, Calif. The contestants ride across 44 miles of open ocean on aquaplanes, or "Ironing Boards."

Last year's race was the first in which

Rider at left is slightly ahead, so rival gets full force of wake, plus that from boat not in picture, making the going very rough

more than a third of the starting contestants were able to endure the grind to its finish—and then the sea was like glass, the waves never over six feet high. Only in that event were there no injuries, in contrast to the half dozen cases of broken arms, legs, ribs, and collar bones that are the normal toll.

One of last year's participants, who got a pretty heavy handicap because of his speedy boat, was making a gallant bid for second place in the race. He had ridden the 44-mile stretch at top speed, was too late to finish first, but looked good for sec-

Mid-ocean battle, with each rider trying to create waves that will throw some contestant off the board



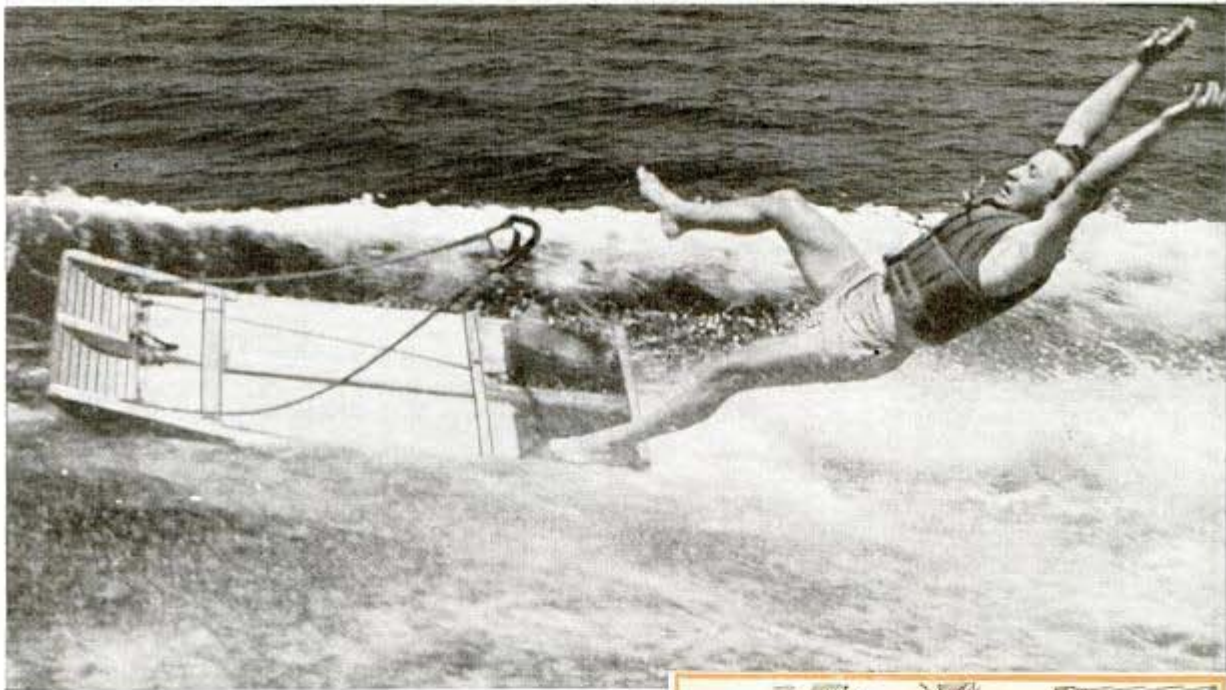

Into the churning wake goes this rider as water gets so rough he can hang on to his board no longer

ond. As he neared the finish, spectators saw that he was not holding his rope, but had passed it around his back, and his hands were hanging limply—he was too far gone to hold on any longer.

A cheer that went up for his courage died in a gasp. Forty feet from the finish line, he collapsed. He did not fall off, he did not get knocked off—he simply didn't have 40 feet left in him. When a man cannot hold on for 40 feet more at 50 miles per hour, he is through, and only sheer exhaustion can account for it.

The first race was held in 1935, and was really more of a stunt than a contest. Since then the fame of the event has spread, with aquaplane riders coming from all over the world to participate. It is the only aquaplane race sanctioned by the American Power Boat Association, and so far as is known, the only aquaplane race that uses open, uncharted ocean for its course.

Speeding across 44 miles of open sea creates problems that few other races have to contend with. There are no landmarks and the boat operators depend almost exclusively on navigation instruments to tell them where to go. Since a one-mile diversion from the true course is enough to lose the race, it is easy to see that teamwork between the rider and the operator of the boat is vital.

Some of the participants spend weeks

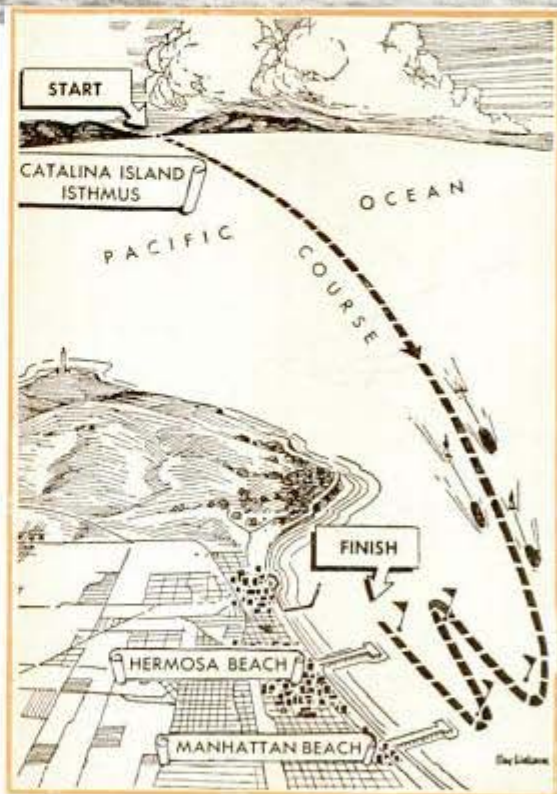

This map shows the course; uncharted, it calls for boat operators to use navigation instruments

going over charts of the ocean winds and currents, trying to outguess air and water movements to their advantage. Some have been rather successful. The general practice is to start from the island and head straight for shore, but it may pay to lose a mile or two if one can find a current traveling two, three, or four miles per hour.



Down into the brine goes another contestant as wakes from two other boards make it impossible to hang on another instant; spilling rival in this manner is not prohibited



A three-way contest, with center rider (the same one who fell in photo at top of page) getting the worst of it

Weighing in ceremonies for the boards. This one, four pounds too heavy, had to be dried in hot sun before being approved



This race is on a handicap basis; handicappers endeavor so to calculate the speed of boats that if all things were equal, they would finish in a dead heat at Hermosa Beach. Consequently, those with the fastest boats start last, and have to fight their way not only through the normal waves, but through the wakes of boats ahead of them. The rules do not prohibit catching an opponent in the wake of your boat, and making the going difficult, even disastrous. A spill costs a contestant at least four minutes, and spills are many.

To avoid these spills, contestants have made many experiments with their boards and the best methods of lashing them to the boats. Boards are limited to sev-

enty pounds by rules, but there are many variations in design possible. The original boards were simply flat, but these were unstable and took a terrific pounding from the waves. Since then, everything has been tried—fins, keels, round-bottom boards, and a score of fancy geegaws and gadgets. Experience has indicated that fins or keels are an advantage on the round-bottom boards; they add to stability and detract little from speed.

Even more broad have been the experiments with the towing ropes. The bight of the line drags the water, and not only offers some resistance, but when several waves come close together, it is

difficult to get the board over them, and going straight through is a rough process that may spill the rider any moment, and certainly wears down his stamina. In rough water the line has a tendency to whip and jerk, and this poses another problem.

One rider and his boat crew designed a spring reel for the stern of the boat that was supposed to prevent jerking. Every time the line went slack, it was automatically gathered in. This worked fine in rough water, but when a smooth stretch was encountered, the board was drawn in so close spectators thought it was going to pass the boat. Another rider and crew formed a U in the line, and across the crest, they placed heavy strips of inner tubing that were supposed to take up the shock. It was only mildly successful.

Others have designed all sorts of high masts and spars on their boats to tie the line high, figuring to keep it out of the water. Still others have attempted to tie the end up forward, figuring the boat would be more maneuverable under better control. Some of them still swear by such trick stuff, but general experience has been that the line should be tied low in the stern, for the best general performance.

In 1940, Jack Burrud, who won the first race and has ridden in every one since, suffered a fracture of his elbow in an accident. By 1941, he had only partial use of the arm, but he fixed up a special brace,



It's all over for this contestant, shown being pulled aboard boat in mid-channel. A spill means loss of at least four minutes, usually more

and rode the gruelling 44 miles to the finish.

There is the story of a girl whose courage will long be remembered. A rough sea spilled her and she came up with a compound fracture of the left wrist, but she got back on her board and tried to finish anyway. The Coast Guard, which keeps a constant patrol both in the air and on the sea while the race is in progress, saw her left arm hanging limp and pulled her out of the race.

Then there is the story of the two boys who disappeared during a race. Their boat failed to come in at all. Alarm for them soon spread. At last a frantically searching Coast Guard found an oil slick in mid-channel. Their radio flashed word of the ominous discovery and presently the sea was alive with searchers. But no sign of the boys was found. By dusk Uncle Sam

(Continued to page 168)

Here is one of the four girls in the 1941 race, the first in which any girl contestant ever finished



Glass Opaque to Slanting Rays Guards Against Air Raids



Upper half of glass is opaque because it is viewed at angle

Peculiar properties of specially treated flat glass make it transparent to light rays and vision at an angle of 90 degrees, but looked at from above at a 45-degree angle, it becomes opaque. Used as window glass, it is in keeping with the present air-raid precautions campaign. To an observer on the ground, or on the same level as the window, the glass is clear. However, to the warbirds overhead, a factory's windows would give no visible light to mark it as a target.

Automobile Era Ended by War Saw 69,000,000 Cars Built

In the 42 years which constituted the first automobile era, the American factories—now diverted to war production—turned out more than 69,000,000 motor vehicles. In the years since the first world war 61,900,000 passenger cars were built. Wholesale value of the passenger cars built since statistics were first recorded in 1900 amounts to \$44,000,000,000, of which \$38,000,000,000 was made in the last 22 years. Production of trucks reached an all-time record of 1,270,647 in the United States and Canada in 1941, military trucks accounting for about one-fourth of this number, but passenger cars built last year totaled only 3,838,345, leaving the year 1929 still on top

with 4,794,898 and 1937 second with 4,068,935 cars. All passenger car production for private use ceased by government order in February with about 600,000 of these cars still await rationing.

Sash Cord Easy to Install With Window in Place

Replacing a broken sash cord, ordinarily requiring removal of the window sash from the frame, can be accomplished in easier manner by using a cord having a flat brass strip attached at one end. The job is simple. Removing the loose pocket cover exposes the sash weight which then is lifted out. Then the brass strip is fed downward between the window sash and the frame, bent along the bottom of the base rail and secured with screws. The cord is then inserted over the pulley and fed down into the pocket, where, with the window as high as it will go, the cord is tied to the weight, leaving the cord short enough to allow for some stretch. Swinging the weight back into the pocket and replacing the cover completes the installation.

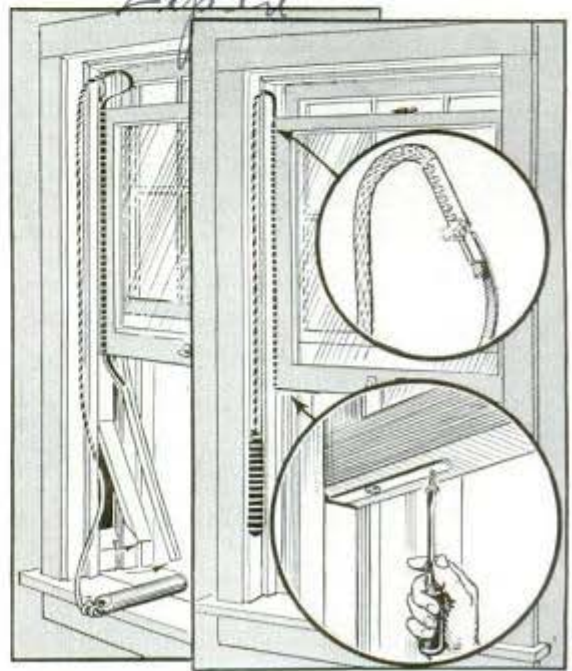

Sketches show how metal strip slides with window sash, and rope, attached to weight, rides over pulley

7n 103.

Jap "Sub" Had Guard for Cutting Net in Harbor

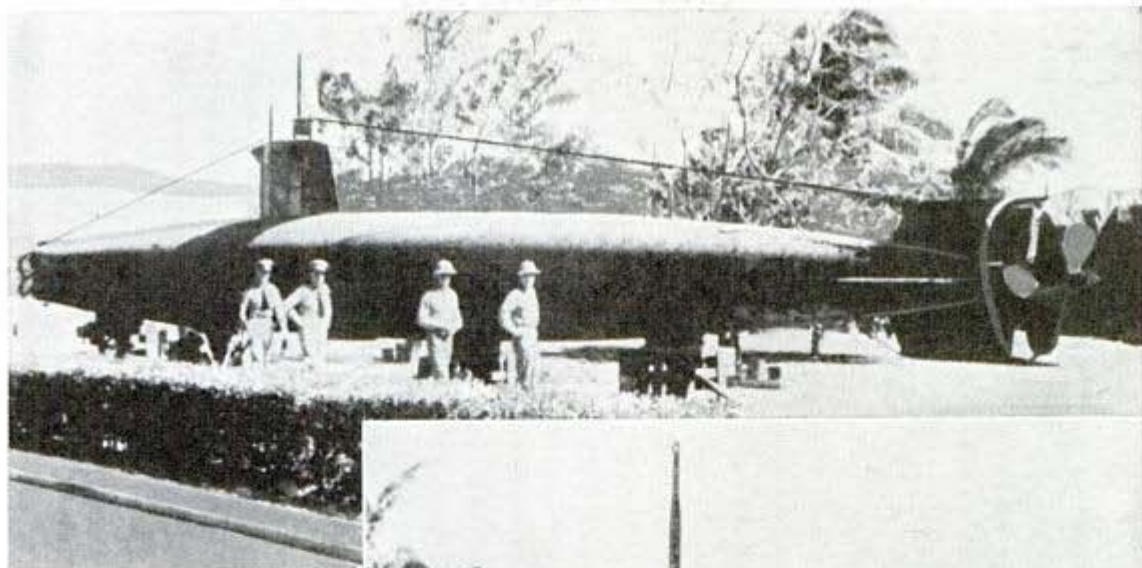

Examination of a two-man Japanese submarine that was captured during the attack on Pearl Harbor shows that it had no chance to carry out its destructive mission. The craft's two torpedoes remain in their 18-inch tubes. At the prow is mounted a knifelike guard with which it was intended to cut through the submarine net protecting the American base. The vessel, 41 feet long, with a plating one-quarter-inch thick and a conning tower four and one-half feet high, has a speed of 24 knots. It could be carried aboard a larger vessel and probably launched over the side. The baby sub has a cruising range of 200 miles.

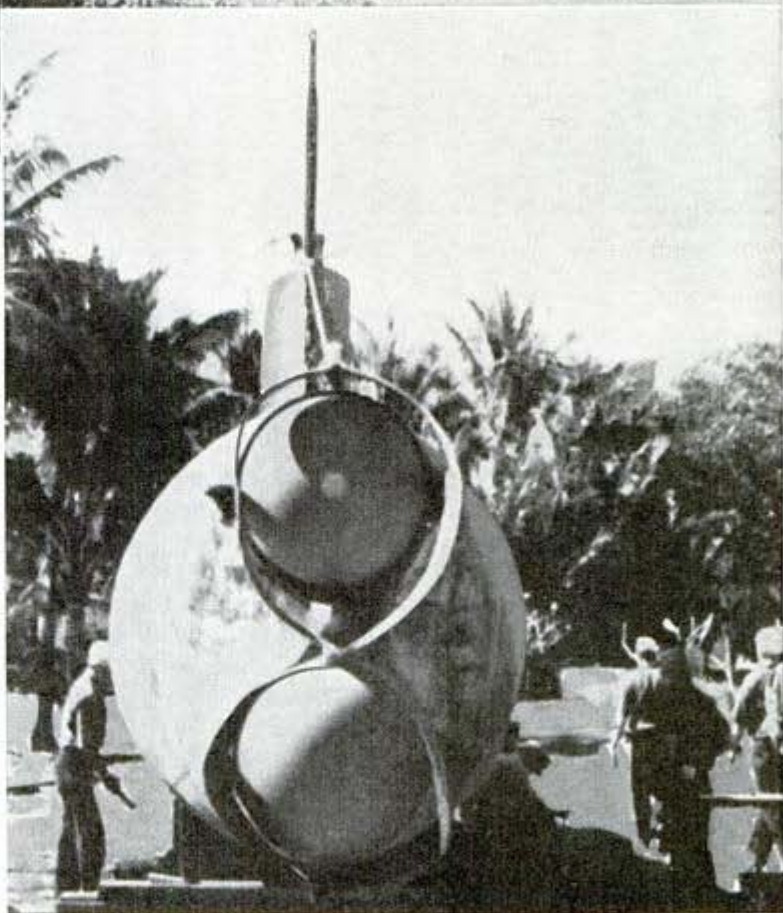

Men walking alongside submarine, top, give some idea of its small proportions. Bottom, knife-sharp cutter at bow intended to cut harbor net

m 99

Lightning Enriches the Earth by Producing Nitric Acid From the Air

Lightning has some good points as well as bad. In streaking through the atmosphere at 60,000,000 miles per hour, thunder bolts release nitrogen from the air, which later falls in the form of nitric acid with rain drops to enrich the soil. In this way, Westinghouse engineers explain, nearly 100,000,000 tons of nitric acid are produced

annually. Also, lightning restores the electricity that seeps constantly from the earth to clouds, thus recharging the earth like an electric battery. Two billion lightning strokes, which occur during the 16,000,000 electric storms each year, take part in these processes. An average stroke represents about one billion kilowatts.

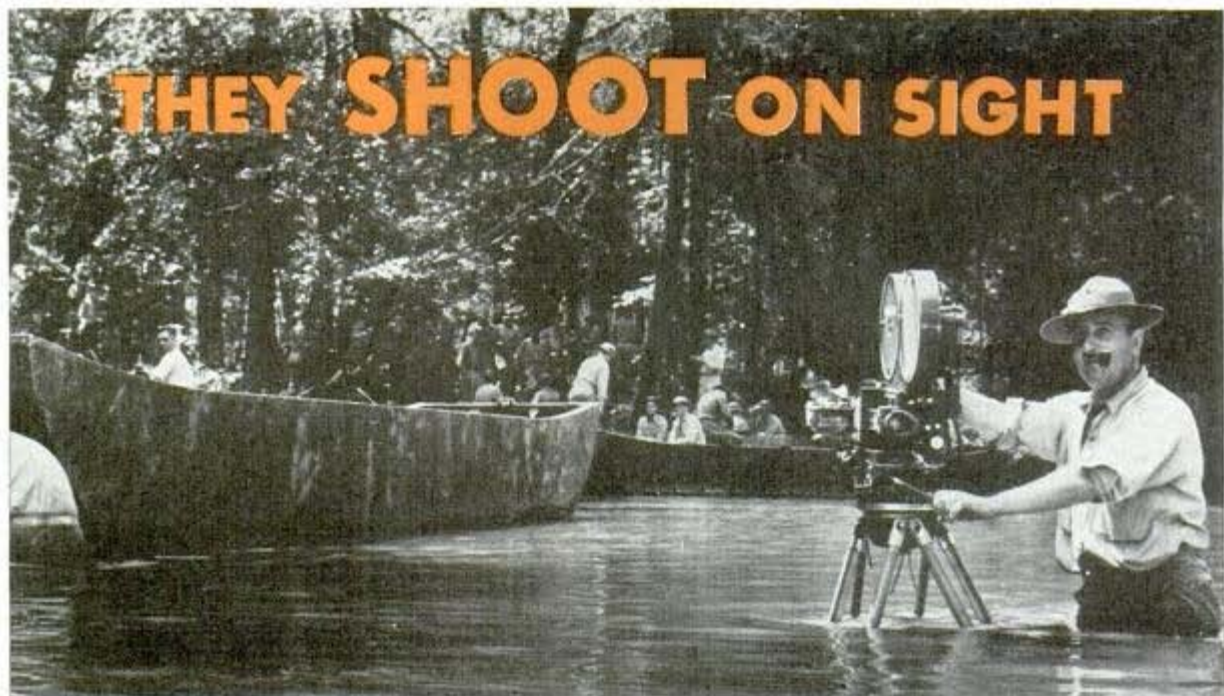

Army barges perform in a landing operation while the cameraman, up to his hips, grinds away in midstream

By Roderick M. Grant

THOUSANDS of feet above the "enemy" lines a U. S. Army "blitz" photographer trips a shutter, thrusts the film into a little black bag and in less than five minutes a finished print showing a concentration of hostile forces is plunging to field headquarters in a metal tube.

Three-dimensional films detect the ground swell of a patch of pillboxes that is flat and barren in the "one-eye" photograph, and the color camera discerns cam-

ouflage that blends in unnoticed patchwork on the black and white print.

The army sees with thousands of glass eyes. Yesterday's amateur snapshotters have been training as Signal Corps photographers at Fort Monmouth, N. J., or air force cameramen at Lowry Field near Denver. Movie men waist-deep in water grind away as army engineers bridge a stream. They go to Hollywood to learn technique for producing training films, and



The army movie camera "covers" war maneuvers, producing a film for officers' study and to train recruits

L1178

graduates of the Disney Studios are loaned to the army to "animate" slide films that teach aerial navigation or gunnery or military traffic control. Just recently the army acquired a large motion picture plant in New York City and is transferring the Fort Monmouth film laboratory to this new photographic base.

Your Uncle Sam's army has always been right up among 'em in the business of war photography. The Signal Corps is custodian of a priceless pictorial record of the Civil War and the World War. The Army was the first institution in this country—probably anywhere—to use motion pictures for mass instruction. In the last year of the World War 60 movies were produced for army training purposes. Today there are many more training films in production, the Signal Corps is pioneering in the use of sound films, and the techniques of army cameramen in '18 are as outmoded as the soundless "flickers" of that day's dime shows.

Troops being schooled for war sit in a lecture hall and watch a battle develop on a screen. A bomb explodes, and the sound of the blast bursts through the room with frightful realism, the purpose being to accustom soldiers to the din of battle. Tank crews see a projectile strike a medium tank and hear the detonation of the hit as recorded from inside the tank. Two tanks crash together in synchronous sight and sound. The peculiar whine of machine-gun bursts ricocheting from gravel accompanies a vivid attack scene.

"Blitz photography" is

MAY, 1942



"Newsreel" cameramen of the U. S. Signal Corps clamber atop a truck to "shoot" a film for Fort Monmouth Training Film Production Laboratory

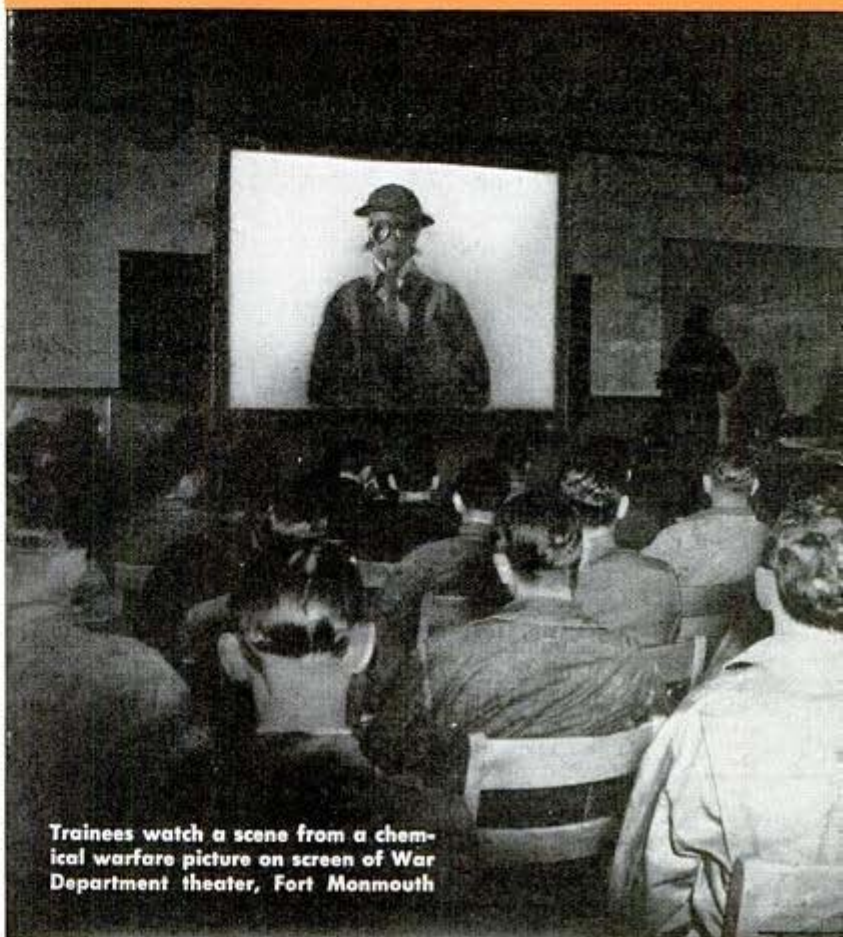

Trainees watch a scene from a chemical warfare picture on screen of War Department theater, Fort Monmouth



From rear cockpit of an observation plane, engineer of the Air Force "quick photography" project at Wright Field trains one of the "big guns"

is electrically heated to a constant temperature of 75 degrees. Development has taken 2 minutes and 35 seconds.

Sponged off with a rubber squeegee, the negative in another half minute is ready for the next stop—an efficient little printer packed in a light-proof zipper bag. Here again the aerial photographer works by the touch system, seeing nothing. Thrusting his hands inside the black bag, he lays the negative on the printer and covers it with a sheet of trans-

one of the specialties at Wright Field, Dayton. Long-range artillery may be firing at an enemy concentration beyond eye range, or "panzer" units may be preparing a surprise attack on the U. S. Army's flank. The commanding general needs immediate accurate information.

An observation plane gets the order by radio to obtain quick photographs. Already "upstairs," the observer trains his Big Bertha camera on the terrain. He needn't focus the 20-inch telephone lens; the plane is high up, and the focus is fixed at infinity. He has only to figure the exposure time and lens opening.

The shutter snaps, and instantly the film holder is pulled from the camera and immersed in the first compartment of a compact four-bin processing tank. He doesn't have to see what he is doing. He pulls the slide up out of the holder and uses it to agitate the holder in the tank, where the negative is developed for one minute. Then he replaces the slide and moves the holder to compartment two for a 15-second "stop bath." In the third tank the negative gets 75 seconds in a fixing solution, then a five-second water rinse in the fourth section. Each section of this tank has a nonspill lid so that its chemicals are immune to the bouncing and banking of the plane, and its insulating jacket, 1½ inch thick,

parent material to keep the printing paper dry. Sensitized paper is then placed over the film and the lid is brought down, making the exposure with light from a single bulb. After five or ten seconds in the printer, the paper gets the quick 1-2-3-4 routine of 20 seconds in the developer, 20 in the stop bath, 15 seconds of fixing and a five-second rinse. Drying is skipped; the wax-treated paper sheds moisture, and the print is immediately thrust into a light metal cylinder with sponge-rubber shock absorbers and dropped to the ground. A waiting motorcyclist or jeep car courier rushes it to the field commander. Working time from shutter click to metal tube is

Complete time and space record of plane landings and takeoffs is filmed, 3 exposures per second, from hut on Wright Field



51178



Photo from U. S. Signal Corps

Shooting a scene for film to instruct soldiers in chemical warfare attack and defense at Fort Monmouth, N. J.

only four minutes and fifteen seconds.

Never satisfied, the Wright Field researchers under Lt. Col. George W. Goddard are working on techniques that may slice time even thinner. One employs the portrait-while-you-wait method of the amusement-park photographer. Here the negative is omitted, the picture being taken directly on paper. Thus far this process has proved inefficient because of the limited sensitivity of emulsions; only in most favorable daylight can a sharp print on paper be captured by the direct-positive system. But the army is trying for paper with a wider exposure range.

Another blitz photography technique utilizes a portable field darkroom developed by Lt. Col. Goddard. Attached to division headquarters, it weighs 50 pounds fully equipped, and can be set

The Signal Corps' training film production crew goes into field to film the technique of soldiers advancing through a gas attack

up in less than five minutes. The darkroom is a camouflaged tent five feet square, supported by four pneumatic arches inflatable by hand pump, air flask or from the spare tire of the jeep. It has a lightproof black fabric lining, rubberized floor that is both waterproof and acid-resistant, and zipper door flaps. A rubber tank holds water for processing, and a small air-con-





Lt. Col. George W. Goddard at Wright Field holds the largest roll of film in the world, used for army aerial photography

ditioning unit provides hot or cold air at the right temperature, whether it's Alaska or the Panama Canal zone. In the world war, photographs were flown to laboratories 30 miles back of the lines and it took hours to deliver prints to field headquarters. Today's blitz photographers can deliver a photograph of an enemy mobile battery before it can move its position.

There are more tricks in the repertoire of the Wright Field technicians. They consigned to limbo the test pilot's knee pad on which he scribbled performance notes while jockeying an experimental ship

Four inflated pneumatic arches support this portable darkroom tent for developing film in the field. Black rubberized fabric makes it lightproof



through rolls and dives; to replace the knee pad they built a "Photographic Observer," a 35-millimeter motion picture camera, a lamp house to provide lighting, and a mount carrying instruments duplicating those on the cockpit panel. At the touch of a trigger switch on the pilot's stick he can record on film the readings from as many as 15 instruments.

To record accurately the take-off, flight and landing performances of planes under test at Wright Field, a gun camera using 35-millimeter strip film snaps three pictures per second as it follows the plane from a portable camera shack opposite the midline of the field. A stop watch is included in the camera's view so that the pictures constitute a precise time-distance record of the plane's trial.

One of the newest tools of the military cameraman is a three-dimensional film invented by Douglas Winnek of Mt. Vernon, N. Y. Unlike the stereoscopic pictures which require two images taken by twin lenses at eye distance apart, the new Trivision film needs but one exposure. Ordinary black and white film, color or X-ray film can be used. Winnek softens the back of the film, then impresses on the back (not the emulsion side) an optical screen consisting of minute grooves, about 200 to the inch. The "lenticulated" film is loaded into the camera, its grooved back toward the subject. The image "filtered" through this optical screen

has depth when viewed as a transparency through the back. From the emulsion side the three-dimension effect is lost.

The Trivision film has been used at a Navy hospital to make three-dimension X-ray photographs of patients. With it the surgeon can gauge precisely the position of a foreign object in the body. With it the air corps photographer might show the depth of a valley, the height of a

(Continued to page 174)

72100

Disabled Tank Rides Trailer to Repair Shop



Two oblique tracks at back of trailer form ramp on which disabled tank is loaded and unloaded

British tanks put out of commission while fighting in the Libyan battlefields are "ferried" across desert wastes to central repair shops on special heavy trailers. Although the tanks are hardy cruisers, they frequently become immobilized since there

are many things that can go wrong. The huge trailer is equipped with two stout steel runways hinged at the back, which can be lowered for hauling the tank aboard. Both the truck and trailer have heavy tires designed for desert travel.

72100

Brake Tester on Wheeled Cart Shows Stopping Distance

Efficiency of automobile brakes can be determined under driving conditions with

a two-wheeled tester that is attached temporarily to the car. Built into the cart and geared to its axle are a speedometer and a distance meter. These two instruments, on completion of each test, show how fast the car was traveling when brakes were applied, and how far it traveled before stopping. A solenoid, connected to a control pad which in turn is attached to the brake pedal of the automobile, controls the mechanism. As the driver steps on the brake he closes an electric circuit, actuating the solenoid, which immediately "freezes" the speedometer and releases the distance meter hand. For testing power brakes or trailer brakes separate from the tractor brakes, a control pad can be slipped over the hand lever.

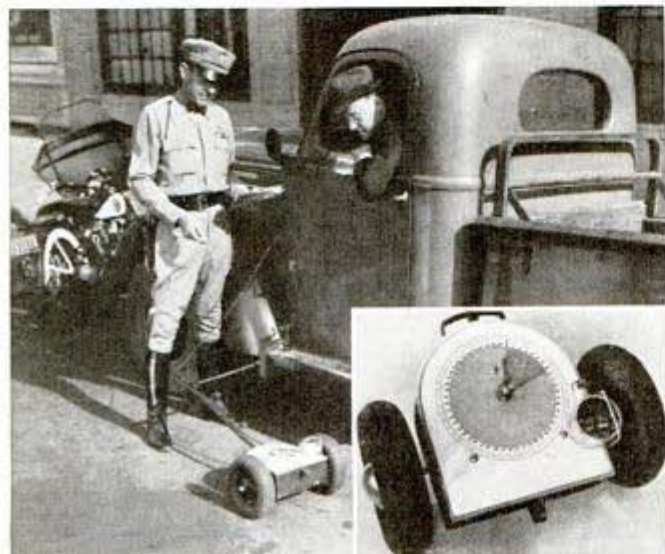

Tester shows how fast auto stops after brakes have been applied.

Cpt. Marshall Perham, U.S. Army, 1141

SHOW



Every patriotic American is eager to display the Flag in this time of national emergency, but not all are sure about the proper ways to display the colors under varying conditions. Above, correct techniques are shown: the Flag on right with state and organizational flags following in order, civilians salute with hand on left breast, sailors give rifle salute and soldiers the hand salute

Sticker type flags should be displayed on right side of windshield. Theoretically they should be at top, but to comply with most state laws, may appear in lower corner above other stickers

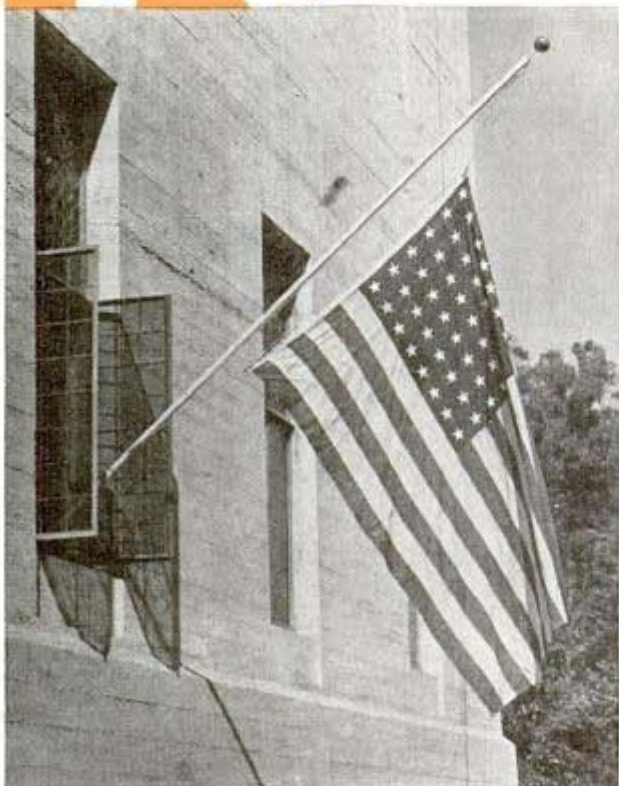

Flag floating correctly at half staff out the window. For projections from buildings, the staff should be either fully horizontal, or at a 45-degree angle

L1141

YOUR COLORS

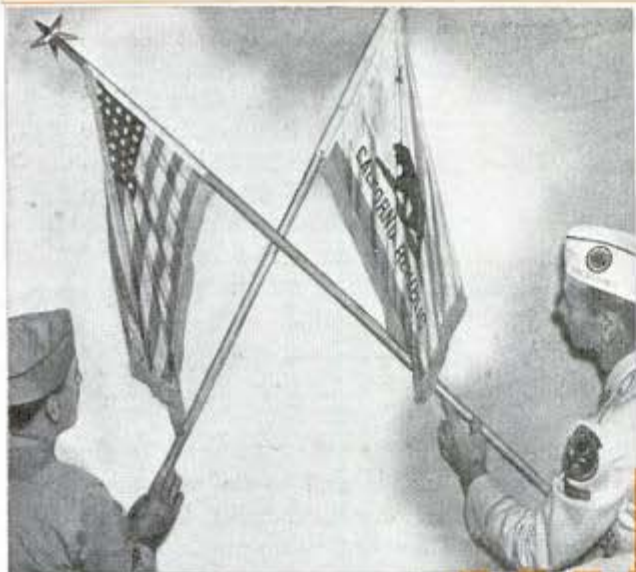

Above, when two flags are crossed against a wall, Old Glory should be on its own right, with its standard above the standard of other flag. Below, star field always should be on the Flag's own right upper corner in a vertical display. The only exception is for a distress signal when the star field is hung downward



Proper place for the Flag on auto is radio antenna pole (above). Place it high to avoid touching anything. It must be detached after dark or in bad weather. Below, in hoisting the Flag, it is attached to halyard and allowed to unfold as it rises. Hoisting should be brisk, lowering slow



Sky Map Lighted for Study By Flashlight Attachment



Turning on the flashlight illuminates the map clearly

Illuminated maps of the heavens are offered in a handy frame to be used with a standard flashlight by anyone studying the skies. Under the four-by-eight-inch glass cover, various maps and charts on tissue can be installed, the names and locations of the constellations appearing white against the opaque black background when the flashlight is turned on. On one sheet appears the international Morse code, which can be learned by dot-dash signaling with the flashlight beam.

Small Bracket to Hold Ant Poison May Be Nailed to Tree

Ant poison can be set within easy reach of the insects by putting it in a tree bracket that helps to prevent children and pet animals from reaching the poison. Manufacture

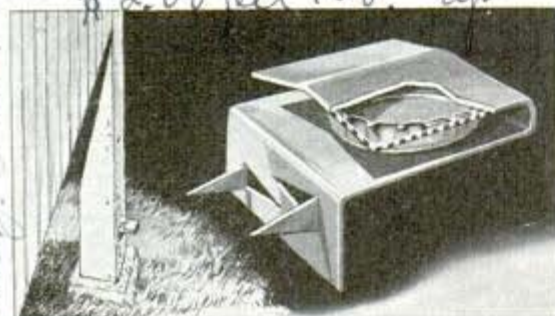

Protective bracket holds bottle cap with ant poison

tured of thin metal in a single piece, the bracket is bent over to hold a crown bottle cap, the latter serving as container for the poison. Two sharp points turned outward are driven into the tree or post in mounting the bracket, and the bottle cap may be filled with poison by means of an oil can after the bracket is in place. One filling usually remains effective two weeks, after which the caps may be removed and replaced with freshly filled ones, and the used caps washed in boiling water. The upper portion of the bracket forms a roof over the cap, retarding evaporation and keeping out dust and rain.

Transparent Plastic Tableware Replaces Metal Servers

Scarcity of metals due to defense production may be credited with bringing more beauty into the kitchen. Made of crystal-clear Lucite and Plexiglas, a new line of tableware includes cake server, scissors-type salad set and pickle tong,



These are a few of the transparent plastic servers

marmalade ladle, pie wheel, cheese knife, salad fork, napkin rings and other "tools." The edges are finished in green, blue, gold or red; attractive color effects are produced by sidelight filtering through. They are rustproof, stainless, easy to clean and lightweight, but care must be taken not to wash them in hot water or to rub them with abrasives or rough cloths.

WANT MORE INFORMATION?

When you want more information about a product described in this magazine, note the page on which it appears and turn to the Where-to-Buy-It index. There you will find listed the name and address of the manufacturer or distributor if the article is commercially available. Write to them and Say You Saw It in Popular Mechanics

U.S. Air Forces

"Pusher" Warplanes Offer Higher Fire Power

Engines in tomorrow's fighter planes and bombers will be arranged to give the craft the best possible defensive fire power, according to designs studied by military aviation experts. Although details are closely guarded secrets, the outward appearances of some have been made known. One, called the "Canard," would fly tail first with the propeller at the extreme rear, thus eliminating rough air over the plane. One four-engined bomber would have two propellers of the pusher type and two of the tractor type mounted in the wings. Both designs offer advantages in the placement of guns.

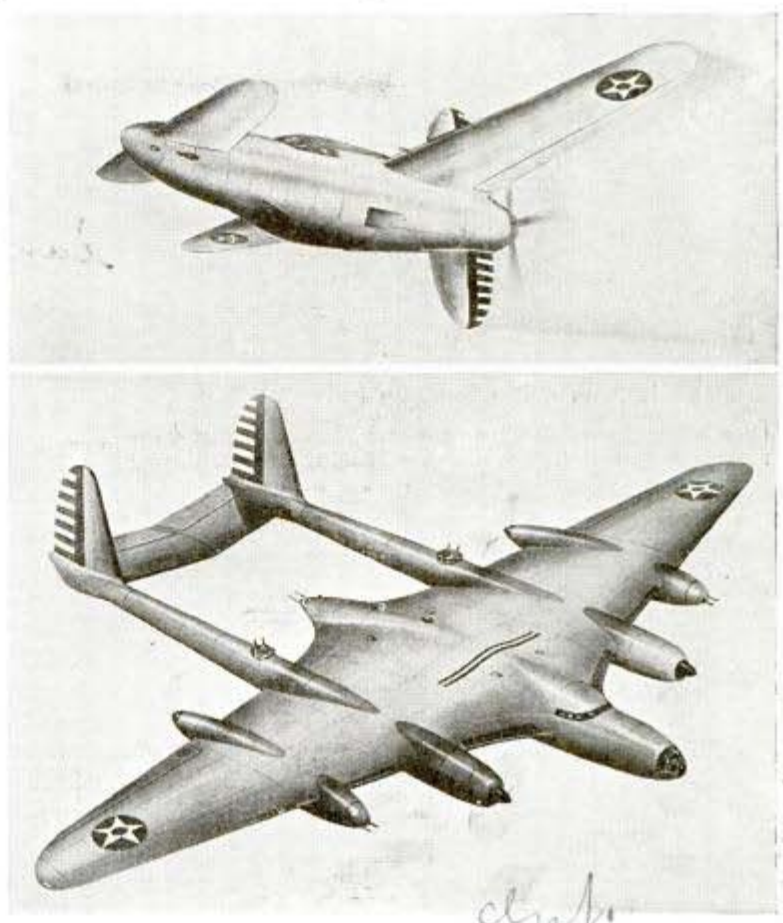

Plane, top, has tail foremost, wings and propeller at rear; bottom, two propellers pull and two push this ship

club

Portable Hand-Operated Siren Used by Air-Raid Warden

M 94
Spartan model 109



Portable siren may be mounted as at left, or carried by air-raid warden.

Useful in districts where electric power is not available, a lightweight siren operated by hand has been introduced here from England for use during air raids. The siren may be mounted permanently on its broad base or slung from the shoulder by straps. Easy for either a man or woman to carry and operate, the siren produces a powerful, far-reaching tone within two seconds. Thousands of the small sirens already are being used in England and other allied countries by fire and air-raid wardens, industrial guards, police and soldiers.

The... Co.
... ..

Baby albatross -

83 volus sailplane
line 13785 Pastor

2/23
Comd. Wallace H. Morris
6902 Magnolia Ave
Chicago



Here is a sailplane in flight—graceful, but highly useful for military purposes. Here it is shown being towed into the air

TRAINING the GLIDER ARMY

San Sebastian
Calif

GLIDERS are apt to play an increasingly important part in the military establishment of the United States, as a means of quickly transporting large bodies of troops and perhaps small tanks.

The Germans demonstrated at Crete the troop-carrying ability of gliders. "Trains" of sailplanes, towed behind airplanes, cast off from the towing planes at a great height and coasted many miles ahead to their objectives. Each glider, according to reports, held about eight fully armed soldiers, including the pilot, and each had separate mobility from the moment it cut loose from the train to make a landing.

Sailplanes are used most advantageously where the fighting is



← John Robinson, a record-holder, in sailplane at Sun Valley, Idaho

This is one step in assembling sailplane from parts carried on trailer

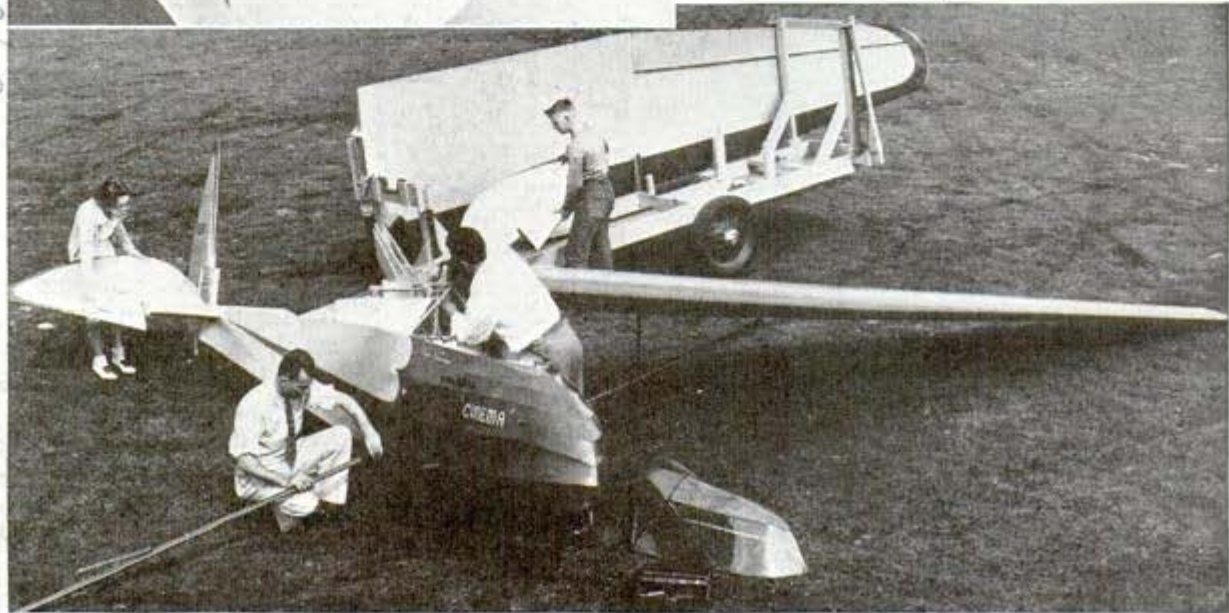

21234

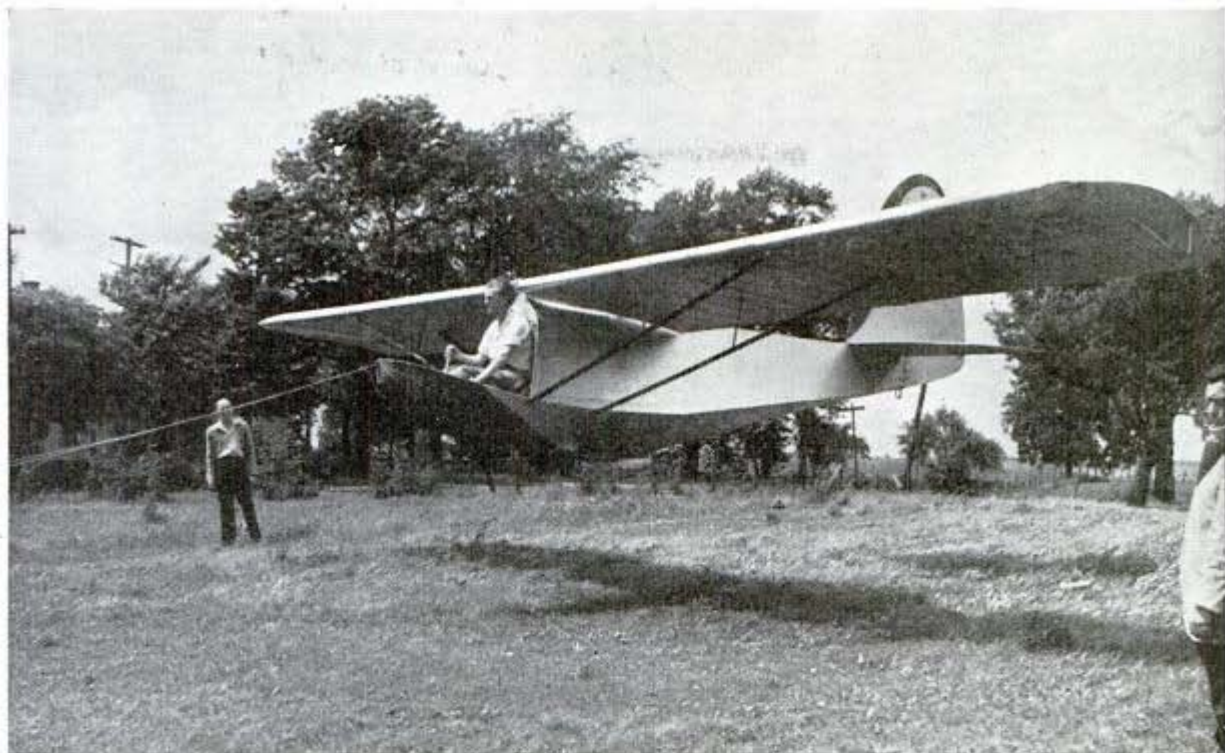

Sailplane just leaving the ground while being towed. Larger craft some day may carry U. S. troops and tanks

over an area so large that troops may be landed from them out of range of enemy fire. Even though an occasional glider crashes on landing, its low cost—a slight fraction of that of a power plane—makes this type of aircraft a relatively inexpensive item in modern warfare.

Last summer two groups of U. S. Army officers, all of them pilots of power planes in the Army Air Forces, took three-week courses in glider and sailplane flying. One group went to the Elmira Area Soaring Corporation's school at Elmira, N. Y., the other to Frankfort-Lewis School of Soaring at Lockport, Ill. This was our initial step so far as military efforts are concerned, in the glider field.

If it were desired to move a force of 100,000 men across the country, it could be done in 36 hours by utilizing about 1,000 transport planes, each towing three gliders of 15-man capacity, at a speed of 100 to 200 miles an hour. They could take full equipment, plus machine guns, light cannon and even light tanks, according to one authority. But the

M.T.J.

Power winch used to launch sailplanes. High in the sky is a sailplane whose pilot has not yet cast off the tow line



MAY, 1942
*Thermal gripper
Schweiger 2/1/42*

2 12 34

Bowlus Sailplanes, Inc
137 85 Stanton St
San Fernando
Calif

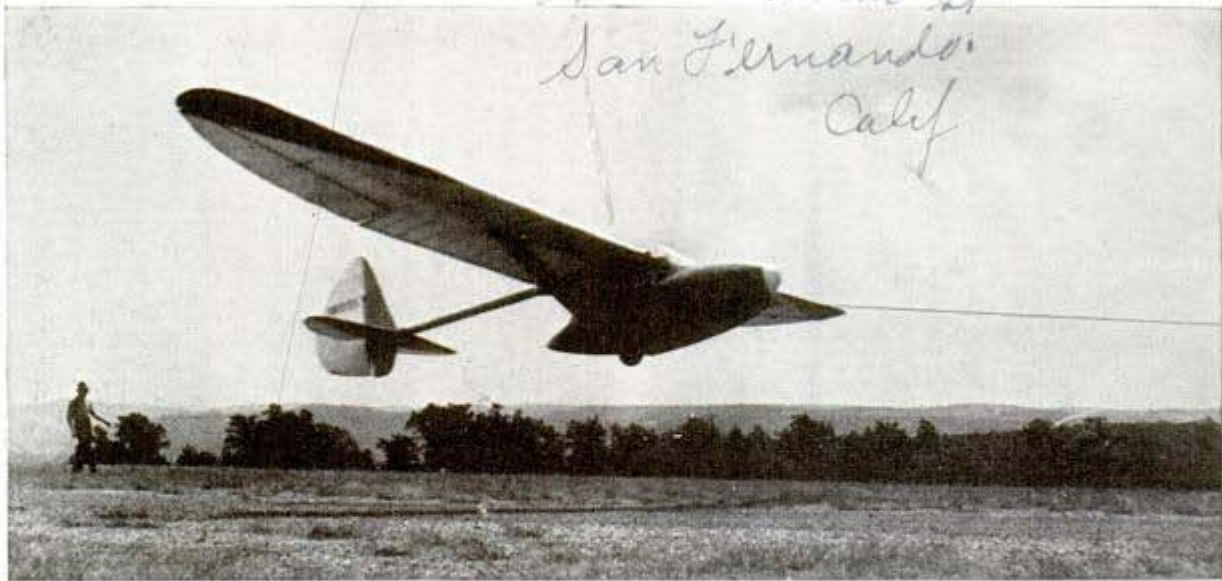

And this is the Bowlus "Baby Albatross" rising from the ground with the tow line plainly visible. German inventors are reported working on designs for sailplanes which will carry ten-ton tanks

vision of the army is not stopping at 15-man sailplanes, for their size is limited only by the power of the planes towing them, hence fifty-passenger craft are within the realm of probability.

Construction of a modern sailplane factory, the entire output of which will be taken by the Army, was started recently at Lockport, Ill., by the Frankfort Sailplane company. The company has been making gliders for civilian use for several years.

The course taken by the army officers at the Frankfort-Lewis school was typical of

both groups. Each pilot received 30 hours' training during the three weeks. Two-place training gliders were used for initial

Germany is developing a glider capable of carrying a five-ton war tank, which would be towed by a large bombing plane, and is designing larger sailplanes to transport ten-ton tanks, according to reports reaching England.

instruction, each man making eight flights with an instructor before soloing. The training gliders are certificated by the

Civil Aeronautics Authority to withstand a speed of 88 miles an hour when towed by a plane.

During the course each army pilot averaged 225 glider landings, and demonstrated his ability to bring his motorless ship down on a designated plot of ground about 25 feet square. Individual flights, sustained solely by air currents, ran from an hour to two hours and twenty minutes.

So far as glider records go, the endurance record is German-held, at over 36 hours in the air without a landing, with return to point of departure. Likewise in German possession is the altitude

This is another view of the power winch with operator at his post



Ann Arbor, Mich

1234

record of 22,434 feet. The Russians, who have long been experimenting in the glider field, hold two records for distance—465 airline miles, and 212 miles with return to point of departure.

American-held records are: Altitude, 17,263 feet, by Robert M. Stanley; airline distance, 290 miles, by John Robinson; duration, 21 hours, 34 minutes, by Lt. William A. Cocke, Jr.

Gliding has its thrills and dangers. Maj. Fred R. Dent, Jr., one of the pilots attending the Elmira course, ran into some of them when he took to the air in company with John Robinson, holder of the American distance record, in a two-place glider. After being towed aloft to 4,000 feet, Dent and Robinson cut loose from their tow. They entered a cloud at 3,700 feet, and started sailing on instruments. The variometer showed that they were climbing and they started to spiral. They passed out of the cloud at 8,000 feet, and again started climbing, while the windshield and wing edges began accumulating ice.

About this time, with the altimeter reading 9,500 feet, the airspeed indicator ceased functioning. Robinson's variometer, in the back seat, was still functioning, and he kept Dent, who was piloting, informed of their rate of climb. At 10,000 feet the altimeter had reached its limit of readings, but the air currents kept pushing them up.

Instrument on nose of two-place sailplane detects rising currents of warm air

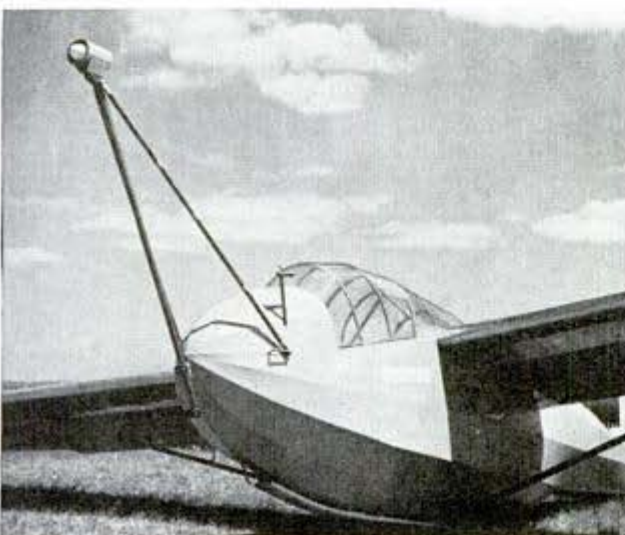

Night photo of pilot ready to take glider into the air

Then the bank-and-turn indicator quit—frozen. Ice was everywhere, deposited by precipitation from the cloud at that altitude. Of the instruments on Dent's board, only the compass continued to work.

They reached what they believe was about 15,000 feet. By the time they broke out of the cloud they were then in, even the floor inside the sailplane was covered with what looked like snow. With no upward currents now, they began to descend, and as they reached lower and warmer levels the instruments again began to function. They landed successfully in a field—but 100 miles from their destination.

Sailplanes are launched by three methods: power-motored winch, which pulls the glider toward it and up in the air by means of a long wire cable winding up on a drum; towing via a moving automobile; and towing by airplane. The winch method utilizes about 2,500 feet of cable, and the glider is able to attain around 800 feet of altitude before casting off.

In taking off behind a power plane, the process is simply one of handling the glider so that it does not add to the difficulties of the airplane pilot. The latter starts his run on the ground for the take-off, while the

(Continued to page 162)

289

"Grass Blitzer" Keeps Army Airfield Trimmed



Tractor, top, tows the nine cutting units; bottom, cutters loaded on trailer for trip over highway

Because concrete and other hard-surfaced runways make wartime airfields easily spotted from the air, the army is now using grass fields extensively. Keeping such fields in condition involves a lot of grass cutting, and this problem has been solved by a tractor-pulled gang mower, called a "grass blitzer," that can trim a 500-acre field in a little more than 10 hours at 20 miles an hour. For transport, the com-

plete mower can be loaded on a trailer which is towed by the same tractor that pulls the mower. In use, the cutting portion is suspended from the frame so it will clip evenly and prevent the appearance of telltale takeoff marks. Equipped with floodlights for night operation, the mower also carries a short-wave receiver so the field officer may signal the operator when airplanes take off or come in.

Phosphorus Made Radioactive Aids Cancer Treatment

Use of radioactive phosphorus in treating certain types of cancer has given encouraging results, according to a report by Dr. John M. Kerney of Memorial Hospital in New York City. Phosphorus is made radioactive in a cyclotron by shooting an extra neutron into the nucleus, or core, of its atom, increasing its atomic weight from 31 to 32. This radioactivity has a "half-

lifetime" of only 14.2 days, but the advantage of activated phosphorus over radium is that the former can be administered by mouth as well as by injection. Since phosphorus is taken up more readily by the more active tissues of the body, the element becomes concentrated in the malignant cells where its radiations perform the same work achieved by radium and

Washington Post, 1945, p. 1

Medical Conference of radiologists New York Roentgen Society

7286

X-rays. Of 22 patients with lymphosarcoma and 27 with chronic leukemia, both fatal forms of cancer, about 50 percent were still living after periods of treatment varying from six to 15 months, and several were apparently free from the disease. Although no patient is regarded as cured until he has remained free from symptoms for at least five years, these results, together with research along other lines, inspire hope that medical victory over the disease may not be many years away.

Freight Car 'Hood' Guards the Cargo From Rain

Freight cars can be loaded or unloaded during inclement weather without letting the cargo get wet by erecting a folding canopy about the car door. Consisting of waterproof canvas supported by tubular steel framework, the canopy weighs 40 pounds. When attached to the freight car door it is 7 feet high, 5 feet wide and 5 feet long.

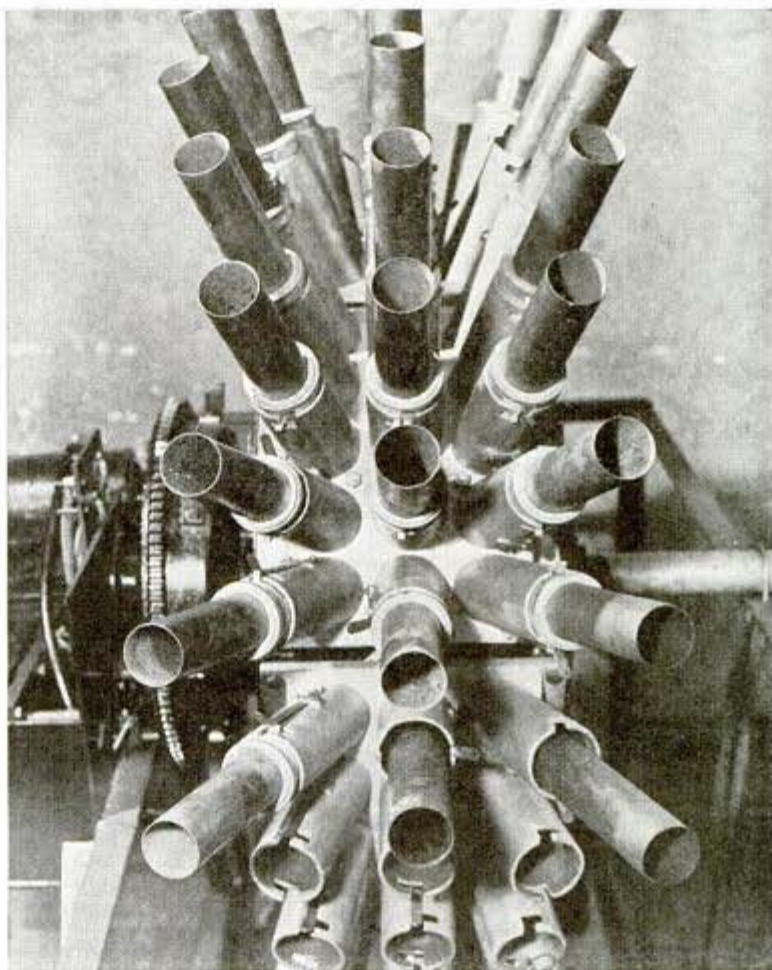
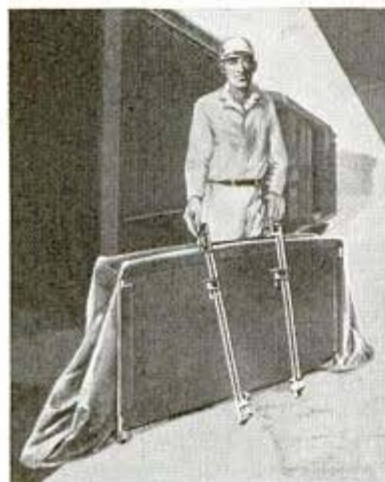

This electrically operated airplane gun fires fifteen barrels at a time

Efficient ground-strafting power is claimed for a new multi-barrel gun designed for installation in an airplane.

Experts say a novice gunner can learn its operation in a short time. The gun is operated electrically, will not jam and fires 15 shots with a single push of a button. Solid shot, shrapnel, gas shells or flares may be fired, and it is said that a single plane armed with this gun could virtually wipe out an entire squadron below.

Look in the index to find where to buy articles described in this magazine. Say You Saw It in Popular Mechanics.

When folded as at left, canopy takes little storage space. Over freight car door, it keeps rain and snow from striking cargo being loaded, right

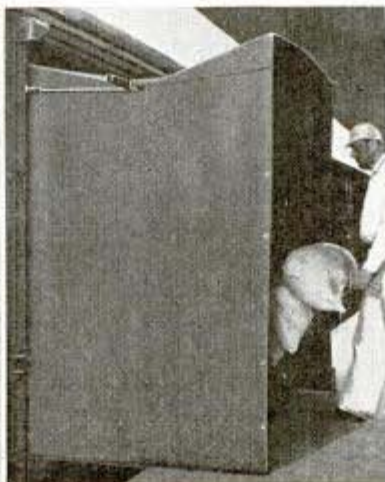

*General Mail Department
2021 Pennsylvania Avenue
Washington, D.C.*

2 1342 Cont. Pac. Slabry.
 4485 Beverly Blvd.
 Los Angeles

MINING A CITY DUMP

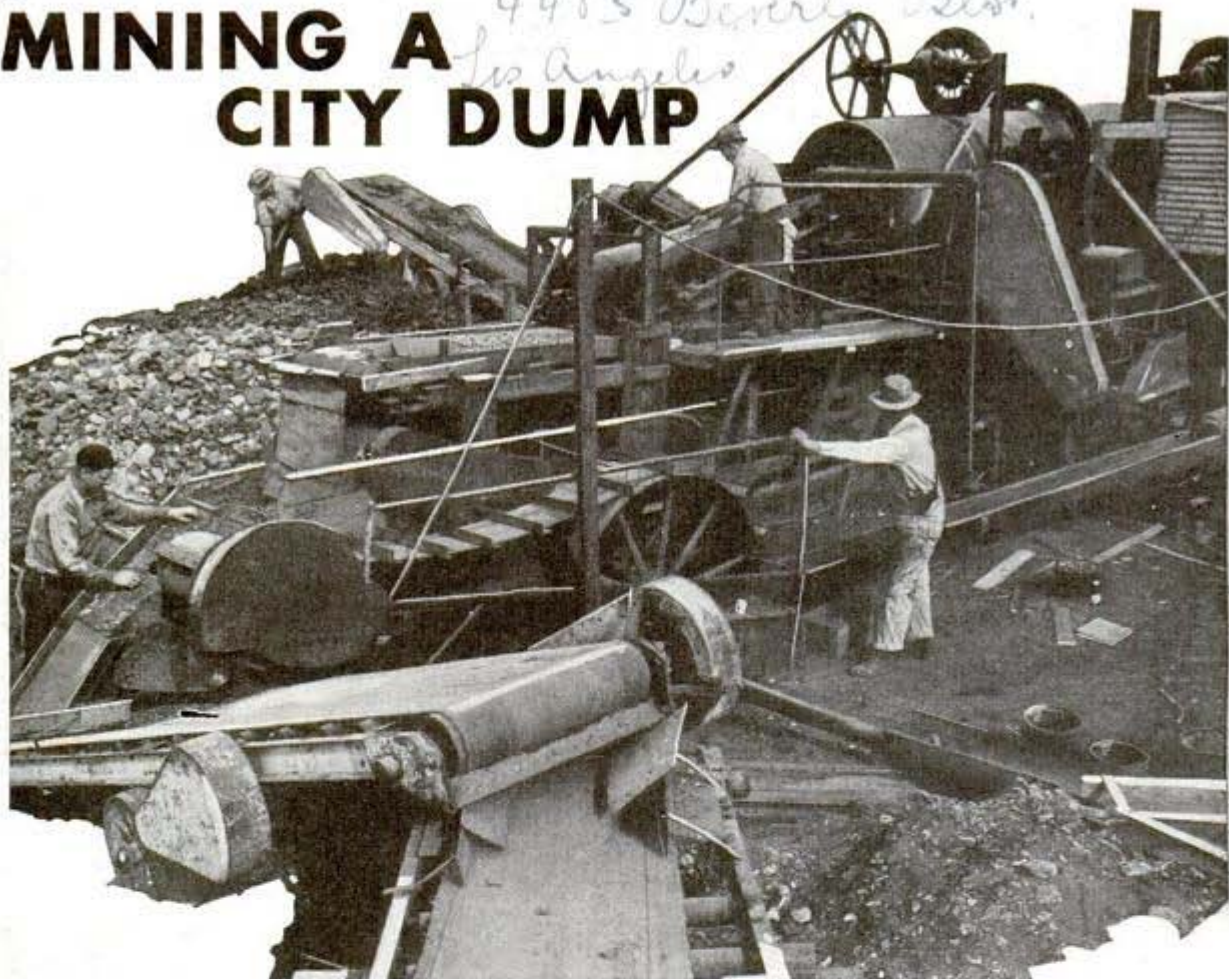

The mechanical monster at top sorts iron, copper, lead, zinc and other useful metals from useless junk in city refuse. Below are some of the odd finds; tweezers point to coin that stopped a bullet

WATCHING amateur "prospectors" pick over the city dump, A. W. Hudson of Los Angeles decided it must be a gold mine of war-precious metals. He determined to mine it. With his chief engineer, Hudson rigged up an ingenious mechanical contraption to sort the thousands of tons of junk, and went into business. The sprawling machine, an arrangement of belt conveyors and magnets and gravity washers, was built entirely from junk parts. A dragline feeds 100 tons of waste materials daily to the main conveyor. The junk rolls into a large drum where it is broken up by rotation and washing—the placer method. A screen separates heavy pieces. The rest is divided into fine and

A. W. Hudson



Commercial Sandblasting Co. 26 28 E. 26th. L.A. Cal

1342

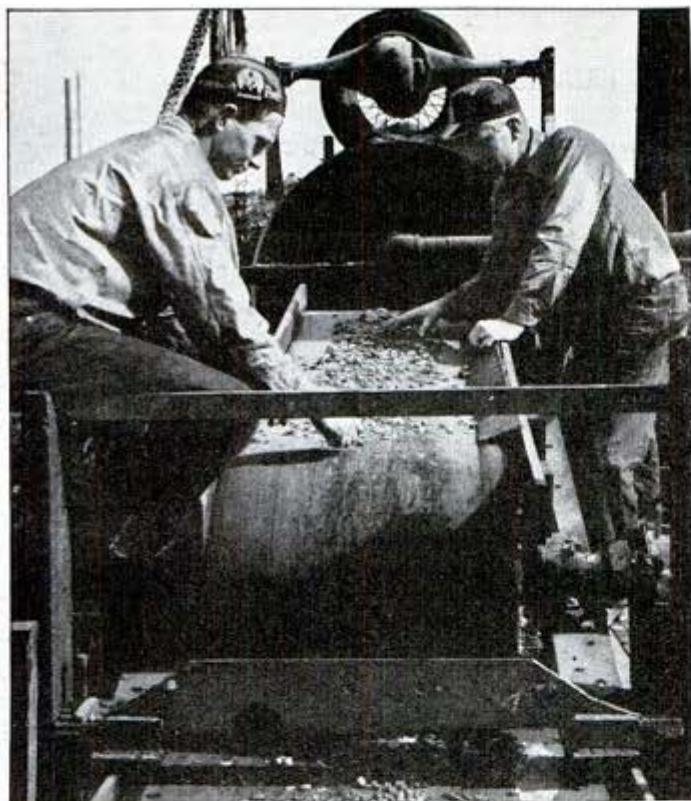

Inspecting the final scrap material at the end of the "belt line" sorting system, to hand-pick any gold, silver or aluminum before the unwanted remnants are dumped



Here is a basket of silverware recovered from the dump to be refined again into usable metal

Below, operators watch the material as it is drawn from the junk pile by the main conveyor

rough streams and sent over magnetic fields which pick up iron and steel. The remainder goes into a jig which by gravity sorts copper and lead from worthless mud, glass and the like. Operators watch the stream to hand-pick any gold, tin, silver, aluminum or zinc. The fine-combing process has turned up a profitable bulk of usable metals and a strange collection of jewelry, medals, coins and odd trinkets.



Sorting the scrap iron and steel with a fork as it drops from the endless conveyor

m 4-7-

Two-Prong Tire Remover Avoids Pinching Tube



Tool pries tire at two points to avoid pinching tube

Equipped with two prongs spread widely apart, a tool for removing tires helps prevent pinching the tube because it permits the operator to see the tube while he is working. No special skill is required in its operation, and the tool removes tires with the wheel on the car or on the floor.

Tool Inserts Rivet From Outside And Crimps It by Leverage

For riveting parts which are accessible from only one side, a tool now on the market inserts a tubular rivet into a "blind

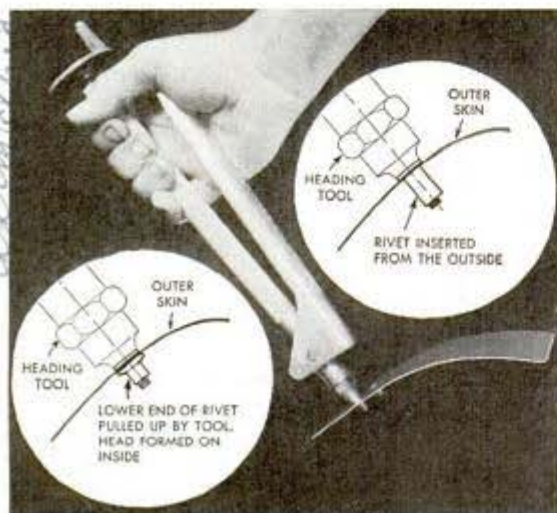

Insets show how tool inserts rivet and forms head

spot" and clinches it without the assistance of other tools. The tubular rivet is threaded inside so it may be screwed onto the mandrel of the tool for insertion into a prepared hole. With the rivet in place, the tool applies powerful leverage which collapses the rivet to form a holding bulge on the inside. The mandrel is then unscrewed from the rivet, the entire operation requiring about 15 seconds.

Patch for Screen Door or Window Fastened by Lead "Buttons"

Torn screens in windows or doors can be mended with little effort by using ready-made patches equipped with lead fasteners. You select the size patch that will

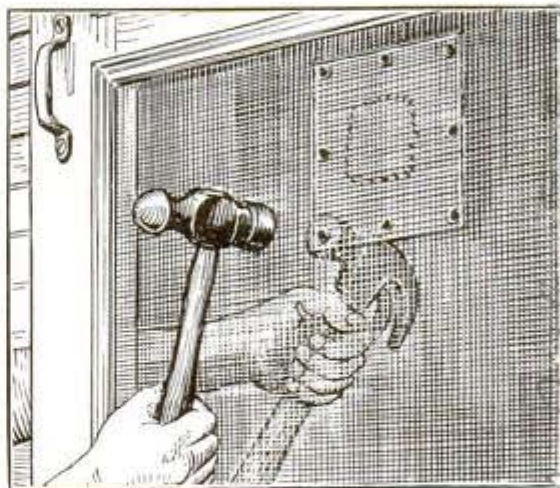

Hammering lead "buttons" clinches patch to screen

cover the break, press the pointed lead "buttons" into the mesh with the fingers, and then pound them with a hammer to make them grip the wires. If the screen is in place, a brick or another hammer may be used as a pounding surface.

Accidental Deaths Cost Industry 47,000 Workers in 1941

At a time when industrial manpower for war production was one of the nation's most precious assets, accidents in 1941 took the lives of 47,000 workers in the United States—18,000 of them killed in occupational mishaps, 29,000 while off the job. This loss in manpower, the National Safety Council asserts, represented enough labor to build 20 battleships, 200 destroyers and 7,000 heavy bombing planes. The death list among men of draft age, 20 to 45, was

Weaver Mfg. Co. Springfield, Mass.

W. J. Hooprich Co. Springfield, Mass.

m 18.
m 26
m 43
D. J. Wacker
D. J. Wacker

no 5?

26,000, sufficient to form nearly two army divisions. The total killed accidentally reached 101,500, exceeded only in 1936 and 1937; the injured numbered 9,300,000, a rise of 200,000 from 1940. One in every 14 residents of the country was disabled by accident during the year. The cost of these accidents was computed at \$3,750,000,000. Highway deaths rose to an all-time high of 40,000, up 16 percent over 1940 although travel increased only 11 percent. On the other hand, industrial deaths were up only six percent while factory employment rose 17 percent and total non-agricultural employment was up nine percent. For the first time in a decade there was no catastrophe which cost as many as 100 lives; a Brooklyn ship and pier fire killed 37 and 36 died in a Maine boat explosion. There were 26,000 deaths from falls.

Squadron of U. S. Navy Blimps Awaits Dawn Patrol

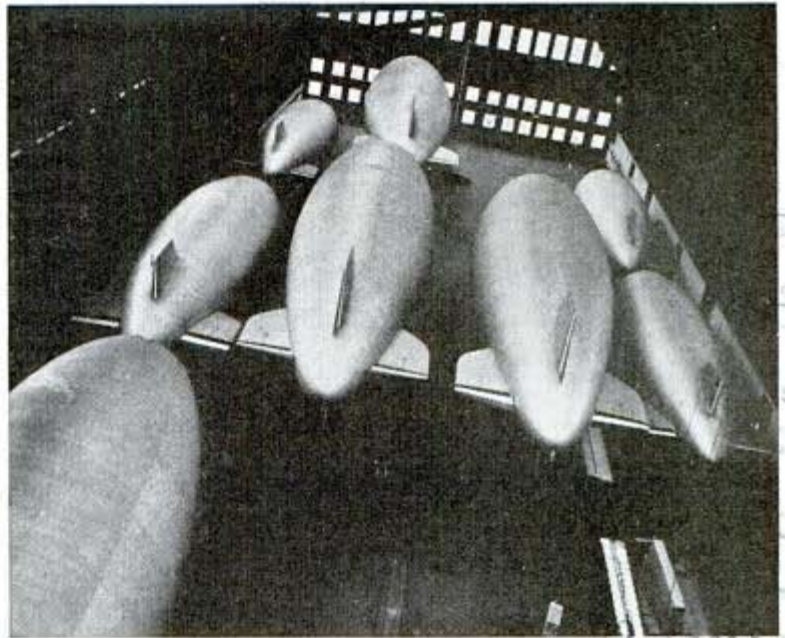

Smaller craft are training blimps, larger are used for patrolling coast

Patrolling the eastern seaboard in a dawn-to-dusk search for enemy submarines is a squadron of U. S. Navy blimps. Between patrols they nest in a big hangar on the New Jersey coast. The blimps carry bombs and machine guns, and, drifting at a slower speed than is possible for airplanes, can maneuver above a suspected enemy craft and drop their "eggs" accurately. Smaller blimps are used for training.

British Seamen Wear "Arctic Visors" on Russian Voyage



Seamen of the British merchant fleet who make regular voyages to northern ports of Russia wear special "arctic visor" masks to protect their faces against the cold and cutting winds encountered along the way. Fitting inside the hood, the mask covers the face leaving only a slit to permit vision. All sailors aboard ships plying the bleak seas receive such masks in their regular kit.

Their faces protected by "arctic visor" masks, these British seamen are ready for icy winds in the far north. Masks are open just enough for vision

How to Make Your Car Do



Examine tires for nails in the treads. They may not cause an immediate puncture, but will result in damage unless pulled out



Now that good oil filters are available, engine oil can be used for long periods without draining the crankcase. However, watch oil condition and replace filter periodically



DURING the first world war, cars two or three years old sold for more than their original cost.

This may happen again, some dealers believe. No new cars are being built to satisfy the normal replacement market, and already used car prices are on their way up. Unless you can afford to pay more for another car you may have to drive your present automobile for the duration of the war. The chances are you will be able to make it last if you take reasonable care of it.

Most of us are accustomed to turning in the "old heap" on a newer car every few years. The old one looks out of date and the new ones have improvements that make them attractive. This habit makes many drivers careless about maintenance, with the result that the average car is ready for the wrecking yard at about 100,000 miles. Most cars can be driven much farther with the right care. Delivery concerns in large cities expect to get upwards of half a million miles out of each vehicle before it wears out.

Since you are going to keep your present car, what can you do to keep it in good shape? Mainly, it's the same old story of proper maintenance. Grease and oil are the two main preservatives of machinery, but grease jobs and oil changes at regular intervals are only part of the story. Modern automobiles require several different kinds of grease and the exact types specified by the factory should be used. The usual greasing doesn't include care of the front and rear wheel bearings or the universal joints. Follow your car manufacturer's or service station's instructions for greasing these parts. The transmission and rear-end grease must be kept at the proper levels and

Smooth-worn tires can be retreaded safely if the carcasses are in good condition

21395

for the Duration

drained and replaced twice a year. Many drivers forget that their shock absorbers need inspection and possible servicing.

Don't use a heavy oil in the crankcase as long as you can get 300 or 400 miles per quart out of a lighter oil. Heavy oils aren't carried up the cylinder walls as well and excessive wear occurs. Many drivers break in new motors on SAE 10 and use it 10,000 miles, then shift to SAE 20 up to 40,000 miles or more. As a result they drive tens of thousands of miles farther than the average before their motors need expensive ring replacements or reboring. When your engine is rebored, remember that clearances are tight once more and break it in as carefully as if it were brand new. Incidentally, it is poor practice to retard the spark setting so that the engine can use low-octane fuel without knocking. When the spark is retarded the explosion occurs while the piston is on its way down the cylinder, and the film of lubricating oil on the exposed surface of the cylinder is burned off, resulting in tapering wear.

Another important point for long engine life is the gradual warm-up every time you start a cold engine. If you idle the engine until the water temperature approaches normal, instead of working the cold engine hard in traffic, bearings and rings will last a lot longer.

Anticipate trouble, and replace worn parts before they fail. Some drivers make a habit of replacing radiator hose, fuel pump, distributor points, and fan belt every 25,000 miles. At the same time, the carburetor is cleaned out and adjusted. On some makes this servicing should be done more frequently. New spark plugs every 10,000 miles help conserve fuel. It pays to reline brakes before they

This polishing machine is putting a fine finish on the bearing surfaces of a crankshaft



Keep your engine clean, using a solvent occasionally to brush the dirt away. The engine that is free of dust and oily grime will run perceptibly cooler in summer weather

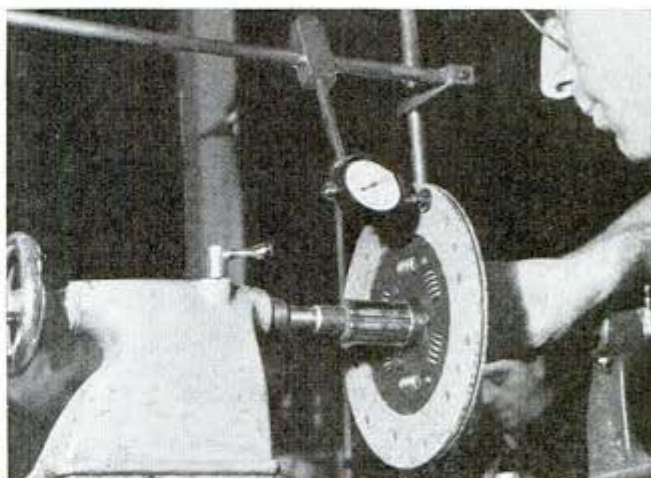

Measuring the accuracy of a new clutch facing that is to go into a rebuilt car. In driving, keep your foot off clutch pedal except when shifting gears and you'll save much wear

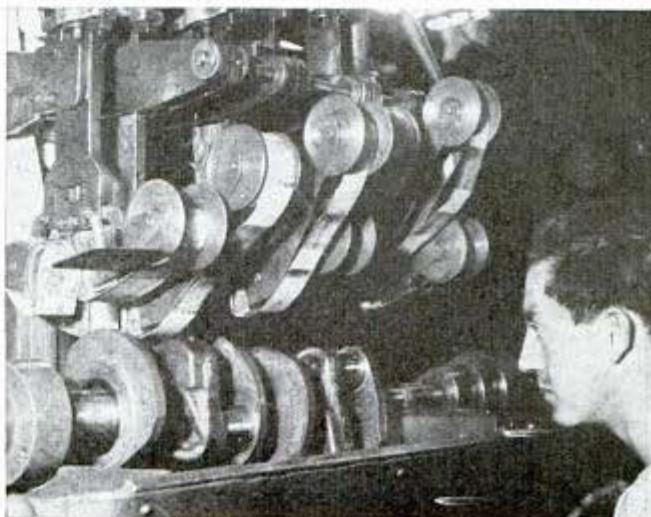



Top, headlight-testing "bomb" fits against headlight to measure its output of light. Below, bathe the air filter in gasoline every few thousand miles, then dip it in light oil



reach the point where every stop is a gamble; for one reason, by that time the drums are probably scored and warped and must be turned down on a lathe.

On most cars the fan belt also drives the generator and water pump. The bearings of these two accessories wear out rapidly if the belt is too tight. Keep it loose enough so that you can push it sideways back and forth about an inch.

Ask a mechanic to check your clutch pedal for proper clearance. Keep it supplied with clutch oil if it is of the wet type. Keep gears in neutral at traffic stops instead of waiting for the green light with clutch depressed, and keep your left foot entirely off the clutch pedal except when shifting gears. The release bearing and pressure plate of the clutch wear out prematurely from such habits.

Have your battery checked occasionally, keep the liquid level up with distilled water, and keep the terminals clean. Use ordinary baking soda mixed with water to wash them, then apply vaseline or cup grease. To keep your radio in good shape, never start the engine while the radio is turned on.

Engine efficiency depends partly on its temperature. Test the radiator water with a thermometer after you have gotten engine heat up to normal by driving it a number of miles. If the water temperature is below 160 degrees or above 180 degrees the thermostat may not be working properly and should be replaced. Too high a temperature may mean the circulating system is clogged with rust or with rubber that has peeled off old radiator hose. Use a rust inhibitor in the radiator to keep it rust-free.

Most drivers can get mechanical repairs and rebuilding done better and cheaper at a reliable garage than they can do it themselves. Modern automobiles are

Telephone receiver on end of metal rod tests rebuilt engine block for vibrations

91295

too complex for unskilled hands and for most operations special tools are necessary.

If you own a Ford, Chevrolet, or Plymouth you can replace a worn-out engine with one rebuilt to factory specifications, at a cost of \$50 to \$75 in most parts of the country. Such a replacement will give new-engine economy and dependability. At such rebuild shops as the one operated by Louie Meyer, ex-Indianapolis race winner, the old engines are completely torn down and cleaned, valve seats are reground or replaced, connecting rods are reconditioned, cylinder sleeves are replaced with new ones, and new pistons, rings, pins, bushings, and bearings are installed. Reconditioning of the carburetor, fuel pump, distributor, and clutch, are extra items and should be done at the time the old engine block is exchanged for a rebuilt one.

Some replacement parts may be hard to get for a time and if your dealer can't supply you the next best bet is a wrecking yard. Parts bought at such places may have had a lot of wear but a worn gear is still better than a broken one. Not all cars in a wrecking yard may be worn out; many new models that have been wrecked may be found there and if your upholstery is worn or the seat springs are sagging you may be able to replace them with material that has had much less use.

Everybody would like high gasoline and tire mileage. Common sense driving will give it to you. Keep the engine adjusted for maximum power but never use all of it. Fast acceleration uses a lot of fuel and a gallon will carry you farther if you accelerate slowly and shift into higher gears at lower speeds. Take your foot off the accelerator as soon as you see a signal set against you. Drifting up to a red light instead of dashing

(Continued to page 169)

Rust inhibitor poured in radiator prevents damage from rust that may clog passages



Loose front-axle bearings can be detected by trying to jiggle wheel; repack bearings every 5,000 miles and keep tight

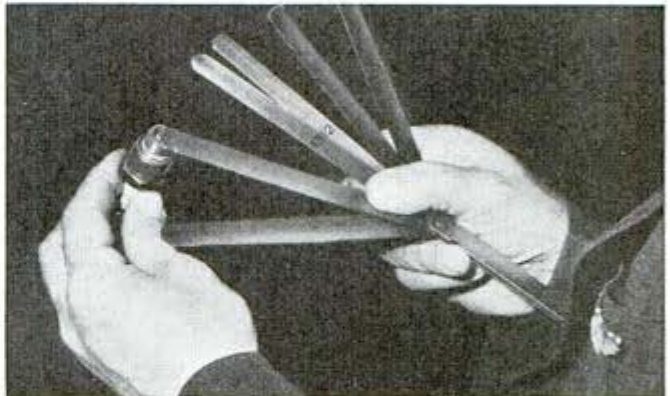

Clean spark plugs and proper gaps aid efficient engine performance. Above, inspecting plug for oil and gap measurement



61

Dirigible Gunner on Open Deck Ready to Blast Enemy "Sub"

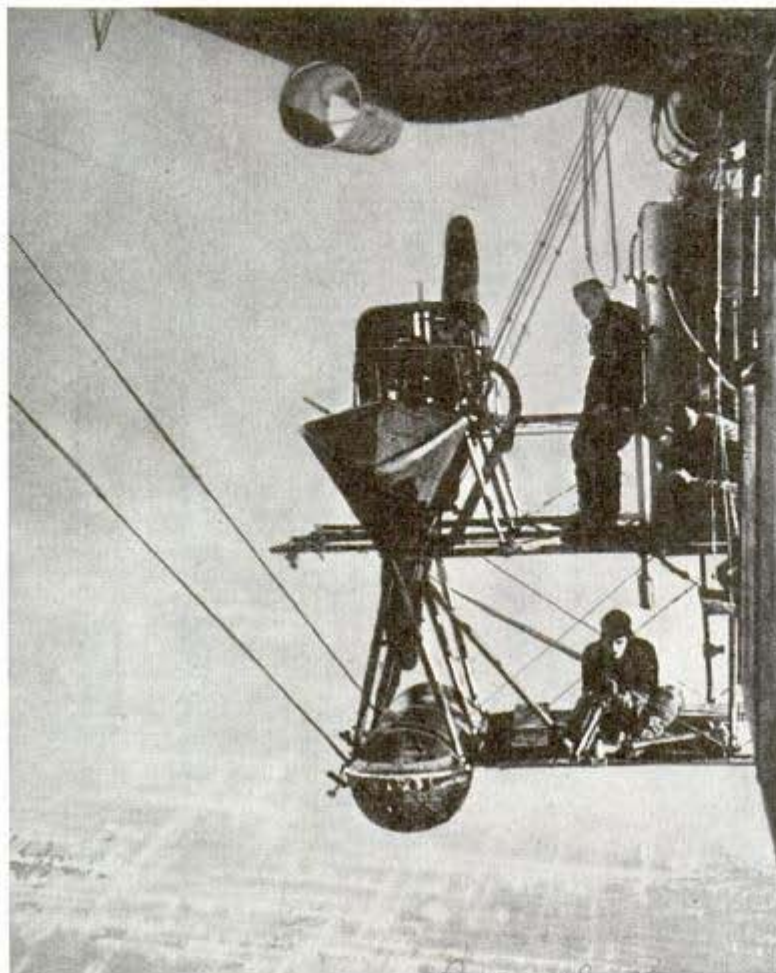

Alert for the appearance of a submarine, gunner keeps finger on trigger

British dirigibles stalking Nazi submarines from the air maintain a never-ending lookout to bag their stealthy quarry. One of the gunners, stationed on an open platform of the lighter-than-air craft, is shown here alert for the moment when he can open fire on an undersea boat.

3/6/42

Rubberless Wheel May Return As Last Resort in Country

If the rubber shortage continues, it is barely possible that the rubberless wheel with springs and shock absorbers will be tried again, at least on farm vehicles and passenger cars in rural areas. It would not be smooth-riding nor permit high speeds, and rubberless wheels are forbidden on most paved streets and highways. Furthermore, it would be complicated and expensive and could not compete with the

most inferior small rubber tire. However, there was a big crop of spring wheels in the early days of the automobile, when pneumatic tires were going flat too often for pleasure, and it is possible a "hard" wheel may be developed should the rubber famine persist.

21370

One-Piece Holders For License Plates Need No Bolts

No bolts or nuts are needed in attaching automobile license plates when new one-piece, S-shaped holders are used. One end of the S-hook is inserted pointing upward into one of the slots in the license plate bracket, and the other end, pointing downward, should be inserted into the corresponding slot in the license plate. Two holders are used for each plate, and after they have been put in place, the bracket, with the nut loosened, is forced downward until the bottom of the plate is fixed firmly in the V-shaped niche at the bottom of the bracket.

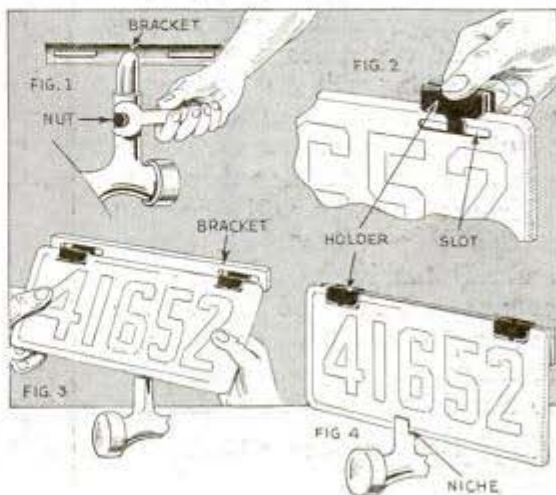

Figures 1, 2, 3 and 4 show how holders are applied

POPULAR MECHANICS

Aurora Equipment Co.



The

CRAFTSMAN



Sturdy, Padded FOOTSTOOL in modern lines

By Benjamin Nielsen

PUZZLING until you know the trick of interlocking the top to the base, the unusual construction of this attractive footstool is sure to intrigue your friends. Fig. 1 shows how it is done by making the base in two parts and then gluing and doweeling both together after slipping them under the hooked ends. As the top thus becomes an integral part of the stool, the tacks holding the cushion must be so spaced to be accessible through the slots in the top of the base, otherwise you will be unable to renew the cushion.

It is best to cut all the pieces comprising the base of the stool from one board of uniform thickness so that the ends will fit



THE SIDES ARE
IN TWO PARTS
TO PERMIT
ASSEMBLY

snugly at the corners. Fig. 2 gives the size and number of pieces required, while Fig. 3 shows where they go. The pieces making up each leg are doweled and glued together in two separate sections, after which both are glued together with a strip of heavy paper between the joint. This permits each leg to be held temporarily in one piece for sanding. After the complete base

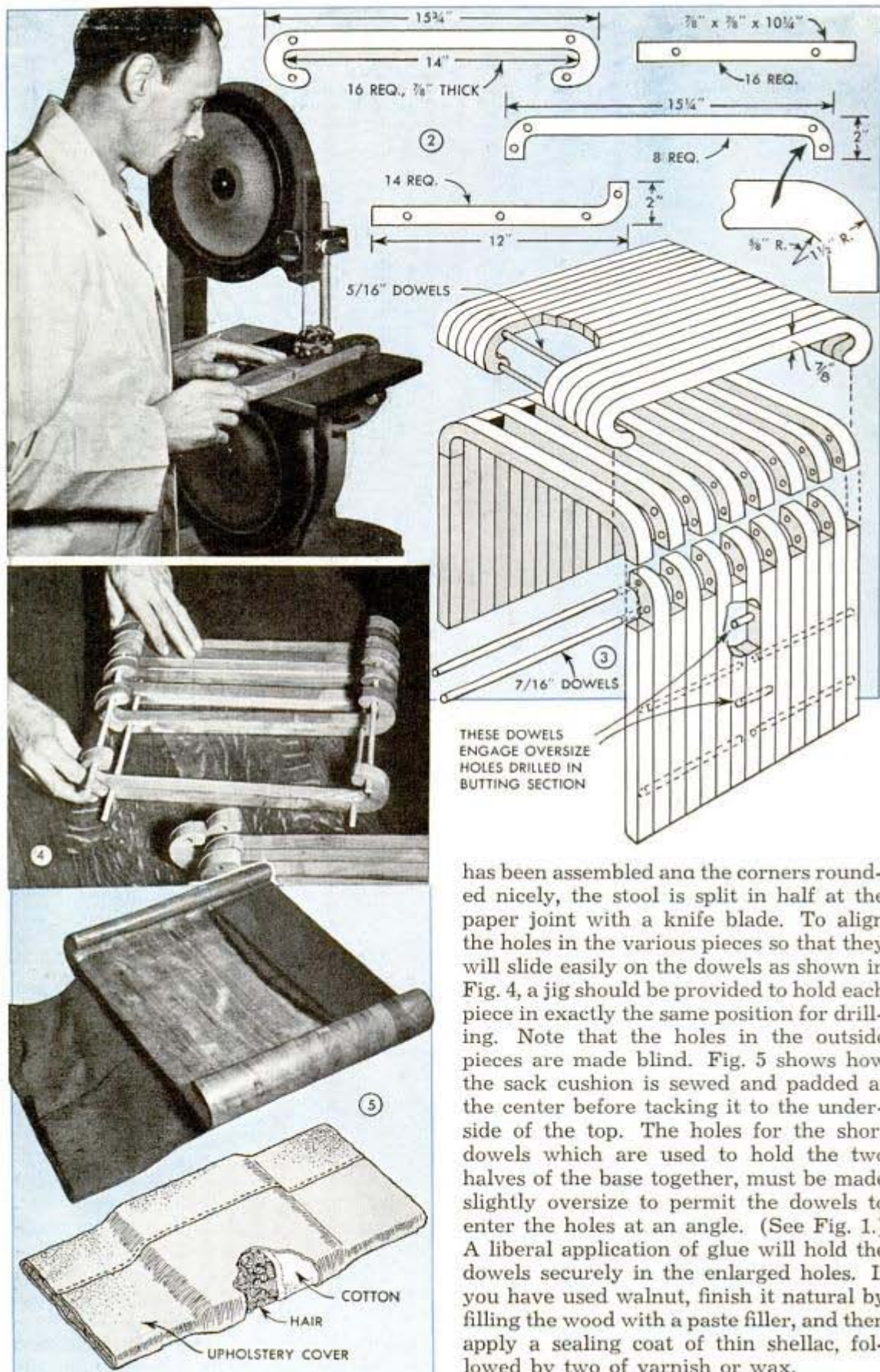

has been assembled and the corners rounded nicely, the stool is split in half at the paper joint with a knife blade. To align the holes in the various pieces so that they will slide easily on the dowels as shown in Fig. 4, a jig should be provided to hold each piece in exactly the same position for drilling. Note that the holes in the outside pieces are made blind. Fig. 5 shows how the sack cushion is sewed and padded at the center before tacking it to the underside of the top. The holes for the short dowels which are used to hold the two halves of the base together, must be made slightly oversize to permit the dowels to enter the holes at an angle. (See Fig. 1.) A liberal application of glue will hold the dowels securely in the enlarged holes. If you have used walnut, finish it natural by filling the wood with a paste filler, and then apply a sealing coat of thin shellac, followed by two of varnish or wax.

Small Power Pack to Operate Electric Razor

Designed and used by a soldier to operate his electric razor while on maneuvers where electric current was unavailable, this power pack will also be found useful by others. It consists of a wooden box containing five radio B-batteries. In this case, the box was of a size to accommodate five BA-2's, radio batteries used in communications units. But any B-batteries available can be used by making the box to suit. The batteries are wired in series and are connected to an outlet plug, which was mounted on a removable shelf that covered the batteries and provided a compartment for towels and shaving accessories in the upper part of the box. A removable mirror was recessed into the lid where it was held by a spring clip at the top and corner braces at the lower corners.—N. R. Arluke, Trenton, N. J.

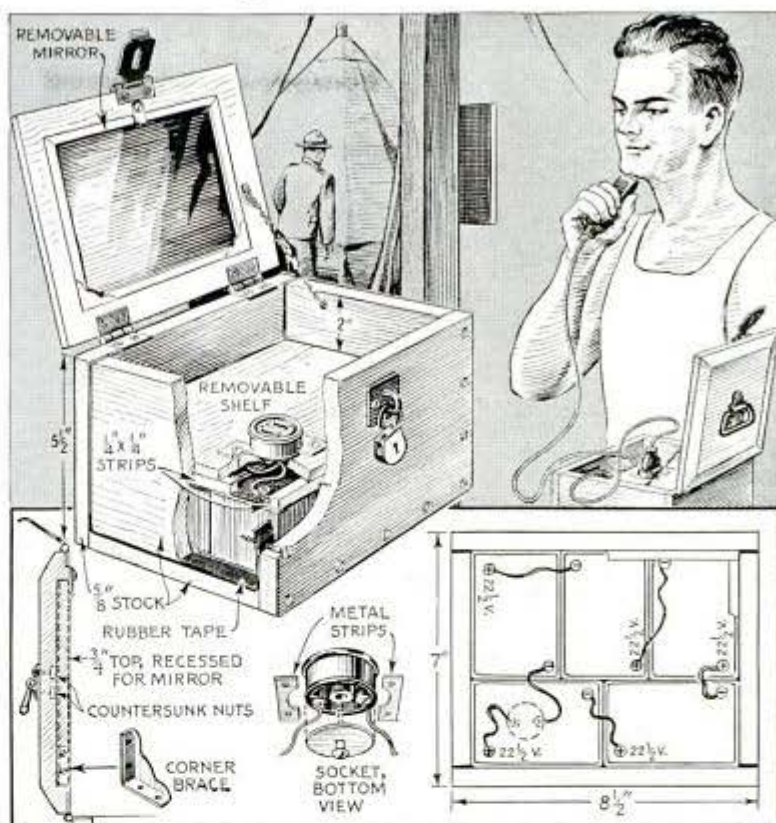

Stripes on Open Garage Doors Caution Other Drivers

If your garage is located along a narrow alley where only a small space is available for turning, it's a good idea to paint black and white stripes on the inside of each door. This will serve as a warning for other drivers in the alley, especially at night, that the doors are open.

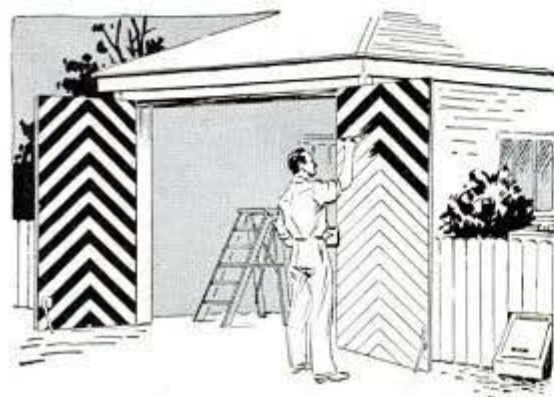

Pegs in Colonial Floor Simulated By Ringed Punch Depressions

When remodeling their homes, many owners like to imitate the old colonial pegged type of floor in at least one room. Often this is done by covering the floor with random width boards and providing false pegs. An easy way to simulate the pegs is to use a short piece of 1/2-in. pipe as a punch to make ringed depressions in the boards at the desired locations. The inside surface of the pipe is beveled at one end to produce a sharp edge. The centers of the depressions are stained slightly darker than the rest of the floor, thus making the simulated pegs stand out.



Solving HOME



1—You'll find it easier to cut canned pineapple into uniform pieces of the desired size if you do it while the slices remain whole in the can. Simply pass the knife through the hole in the fruit and cut outward from the center, holding the knife vertically

2—Asparagus can be cooked extra tender for serving stalk length by placing it with the tips up in the boiler of your percolator. Cut the stalks to fit inside and then add boiling water to a level just below the tips. Don't forget to first scour the percolator well

3—Threads, bits of cloth, etc., can be kept from littering the floor beneath the sewing machine by attaching a paper sack to one end in which to drop the scraps. Tabs of cellulose tape make it easy to remove the sack without marring the finish of the machine

4—Instead of going to all the trouble of getting out your polishing equipment every time you notice a piece of silverware tarnishing a little, just rub it with a freshly cut raw potato dipped in salt to remove the slight discoloration in a jiffy

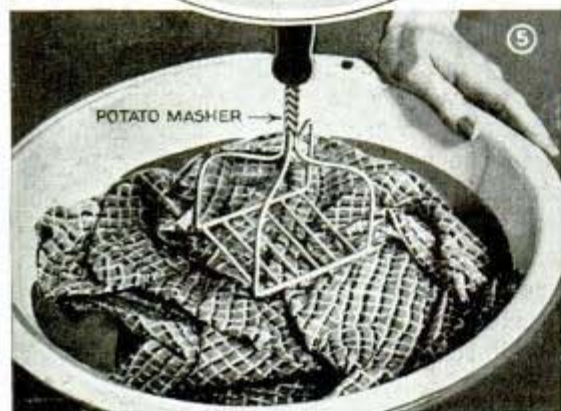

5—Your hands will not smart, and there's less chance of tearing dainty articles of clothing while dry-cleaning them if a wire potato masher is used as a plunger to gently force the liquid through the cloth

6—When you want to leave the lid on a cooking vessel partially raised to emit steam, a spring clothespin and nail clipped to the edge of the pan as shown, provide a convenient support for the lid

PROBLEMS

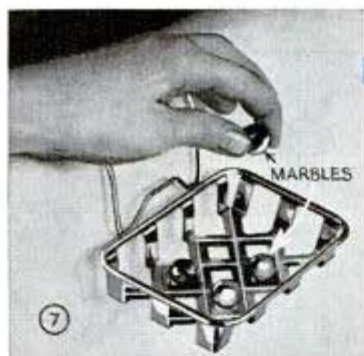

7—Soap will not have a chance to harden in the bottom of a metal soap dish and thereby become difficult to remove, if you put four glass marbles in the dish as shown to keep the bar from touching the bottom

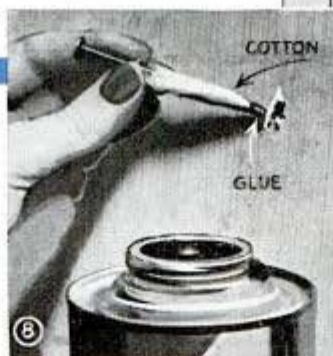

8—Don't make another hole in the wall behind a picture when the nail supporting it becomes loose. Instead, make the nail solid again by dipping cotton in glue and wrapping it around the nail before replacing it in the enlarged hole as shown



9—Squatting to search for utensils stored on low shelves in a kitchen cabinet will not be necessary if the shelves are replaced with a deep plywood bin as shown. This can be pulled out like a drawer for easy selection of the utensils from a standing position



10—Several layers of adhesive tape wrapped around loose coil ties of an uncovered bedspring having a wire framework, will prevent the possibility of catching and tearing the mattress or bedclothes on the sharp ends of the wire coil ties

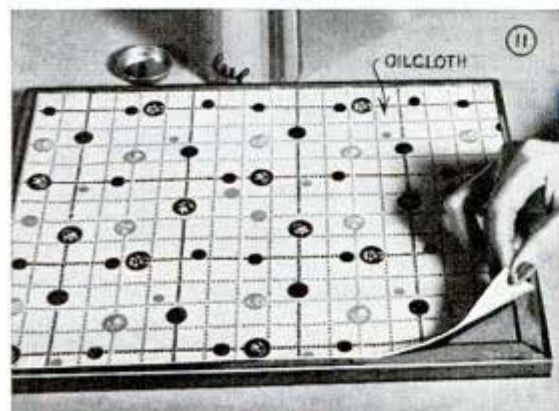

11—Entrance of moisture and dust in framed pictures can be minimized by sealing the backs with oilcloth. Cut it slightly smaller than the frame, coat with glue and press it down in place with the glossy side out



12—Less effort is required to polish a waxed surface if you make use of the weight and convenient grip of an electric iron. Flannel is a good polishing material to use to obtain a high luster quickly

Easy Way to Form Toy Wheels On Your Drill Press

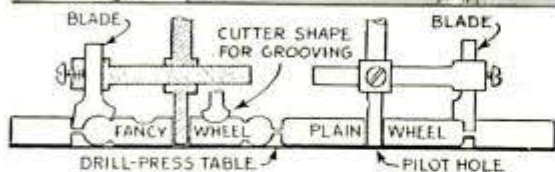
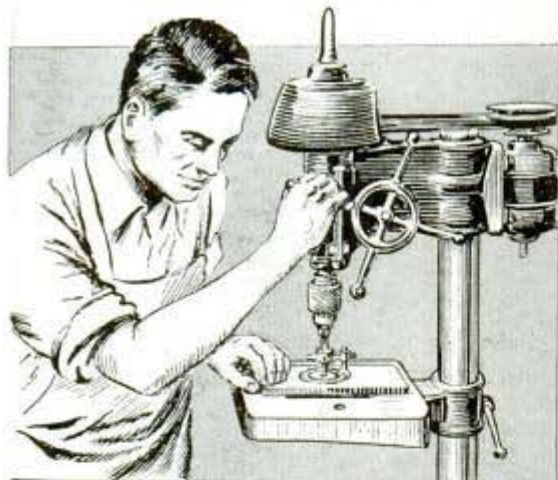

Toy wood wheels can be cut and shaped in one operation on a drill press by using your disk-cutting attachment. The cutting blade for this work can be shaped from an old wood chisel or other suitable piece of steel. The shape of the cutting edge will be determined by the desired shape of the wheel to be cut. As indicated in the lower details, the stock from which the wheel is made is cut halfway through from one side, then it is turned over and the cut is completed from the other side.

Ventilator Shields Work on Desk In Front of Open Window

If you have trouble with the wind scattering papers on your desk because it is directly in front of a window, the difficulty can be overcome easily with an adjustable window ventilator of the type shown. It is



either fastened on the desk top permanently or fitted with two flat-iron brackets on each end to hold it vertically without being screwed in place.

Thimble Holder and Protector For Points of Scissors

Slipped over the end of a pair of scissors, a rubber stopper protects the pointed ends and, at the same time, serves as a holder for a thimble. This idea is especially handy when sewing accessories are kept loosely in a drawer as it prevents injuring the hands on the scissors and keeps the thimble where it can be found easily.

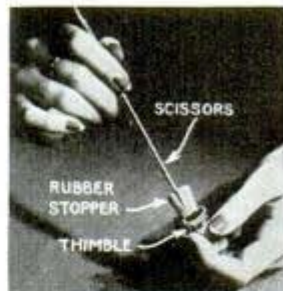

V-Notch in Side of Garden Hoe Removes Tough Weeds



Sprouts and tough weeds may be chopped off more easily with a garden hoe if a V-notch is cut in one side of it and both edges sharpened. Cutting action is improved by the two sharp edges being in the shape of a V and the hoe will not slip off once the weed is in the notch. Also, these edges stay sharp for a considerable length of time as they are not in the ground constantly where small stones tend to dull cutting edges quickly.

FUN with these BATHERS' FLOATS



YOU won't have to worry about tight seams when building these beach floats as buoyancy is provided by old auto inner tubes that fit in place snugly when they are inflated. Legs on the floating duck are supplied by the passenger who propels himself forward with special water sandals. The frame and head of the duck are made of tempered hard-pressed board. The paddling sandals, made of the same material have soles with hinged flaps on the bottom and rubber straps riveted on the sides to hold them in place. The other float is simply a large inner tube stretched over a frame having a streamlined top and bottom. A wood fin screwed to the bottom serves as a keel and a hole in the top provides access to the valve so that the tube can be inflated after it is in place. Paddles are made easily as shown, the blades being riveted at right angles to each other.

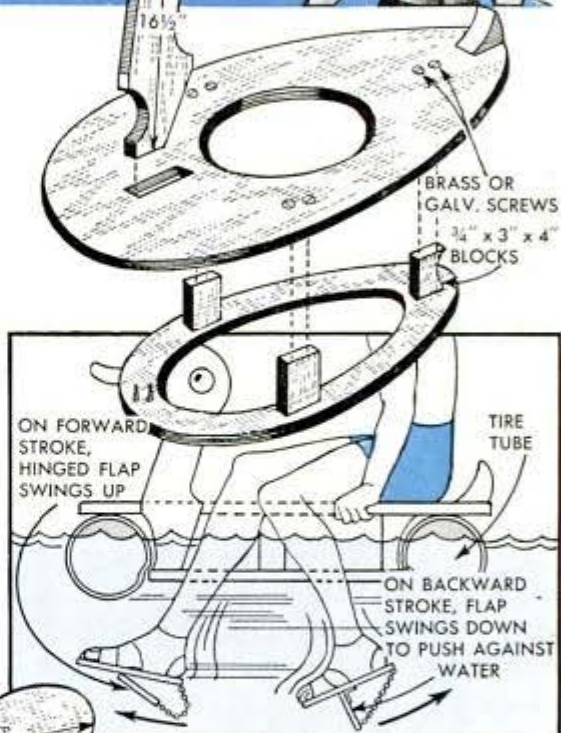

1/4" PLYWOOD PADDLE BLADES RIVETED AT RIGHT ANGLES TO EACH OTHER

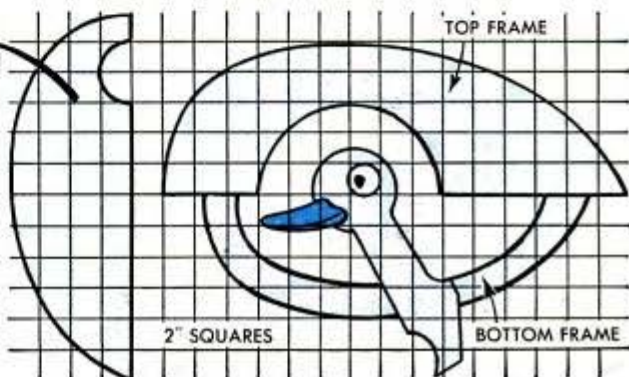
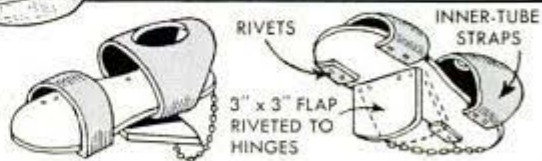
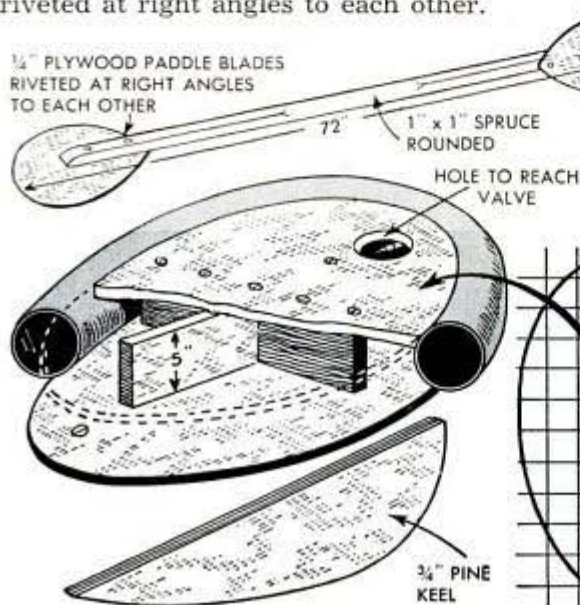

Lantern Held Safely on Boat Deck By Rubber Clips at Base

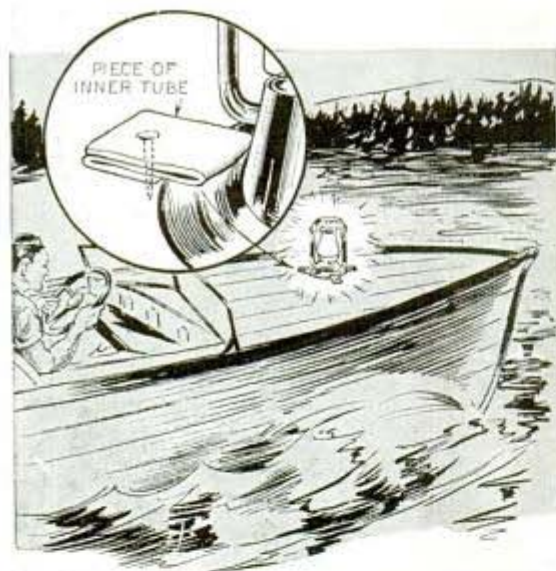

To hold a lantern in a vertical position on a boat deck, one sportsman uses rubber clips tacked to the deck so that they overlap the flange around the base of the lantern. When not needed, the clips can be removed without marring the deck to any great extent.

Chair Back Keeps Heavy Quilts Off Feet of Patient

To keep heavy bed clothing from pressing on the injured feet of a patient, one nurse often employs a chair back. The ends of the quilts or blankets are drawn around the chair and pinned in the manner shown.

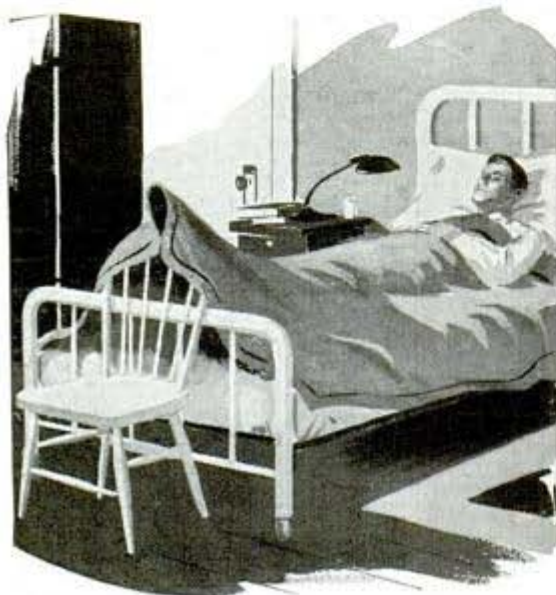

Forced-Air Units Ventilate Home During Blackout Periods

With these simple forced-air units, you can keep one or two rooms well ventilated on warm nights when your home must be closed tightly during blackout periods. Where possible, the unit containing the fan is located at the bottom of one window to draw in air from the outside, and the other unit is located at the top of a second window to permit escape of air. If only one window is available the units are located at the top and bottom of it. Each unit consists of a wood box open at opposite sides, and made to fit snugly into an opening, which is provided by raising or lowering the sash. In Fig. 3, notice that the upper unit is held in place by angle brackets screwed to the window trim, cleats being screwed to the top of the unit to fit snugly against the sash parting stop and to the underside to fit against the lowered sash. An opaque shade to black out the window is suspended from this unit with a 6-in. drop between it and the sash to help trap any light that might escape around the shade roller. The shade slides in grooves provided by screwing wood strips to the window trim as in Fig. 2. The lower unit rests on the window sill and has an adjustable wing on one end to fit behind the parting stop, Fig. 1. The fan-mounting board projects to fit behind the sash and a strip is provided in front on which to hook the bottom of the opaque shade. Each unit has two baffles inside to serve as light traps. The upper one has louvers at the open sides for the same purpose. A screen behind the louvers at one side keeps out insects. The lower unit has louvers at the inner side only. The side that projects out of the window is fitted with a hoodlike frame having a screened opening on the underside to prevent rain and insects from being drawn in when the fan is running.

Selecting a Complementary Color

When selecting paint for finishing pieces of furniture or for decorating a room, good use may be made of the optical method of determining the complementary of a given color. Look at a sample of the color for about 30 sec. Then shift your gaze to a white surface. The after-image that appears is the complementary color. For example, the after-image of yellow is violet.

FRESH AIR *through* BLACKED-OUT WINDOWS

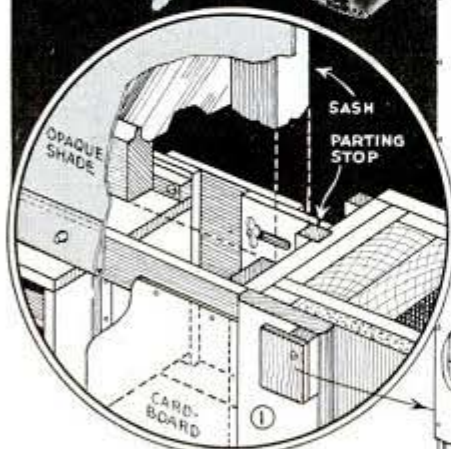
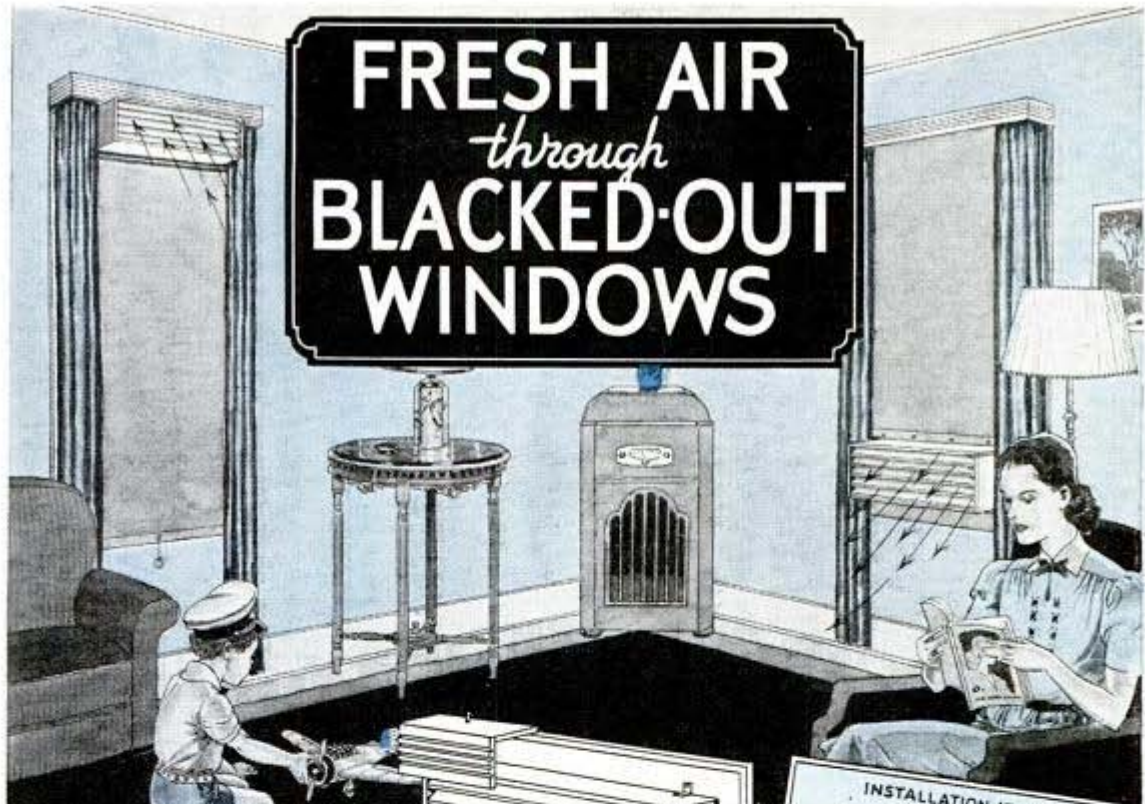

10" EXHAUST-TYPE FAN MOUNTED OVER HOLE

THIS END HOOKS BEHIND PARTING STOP

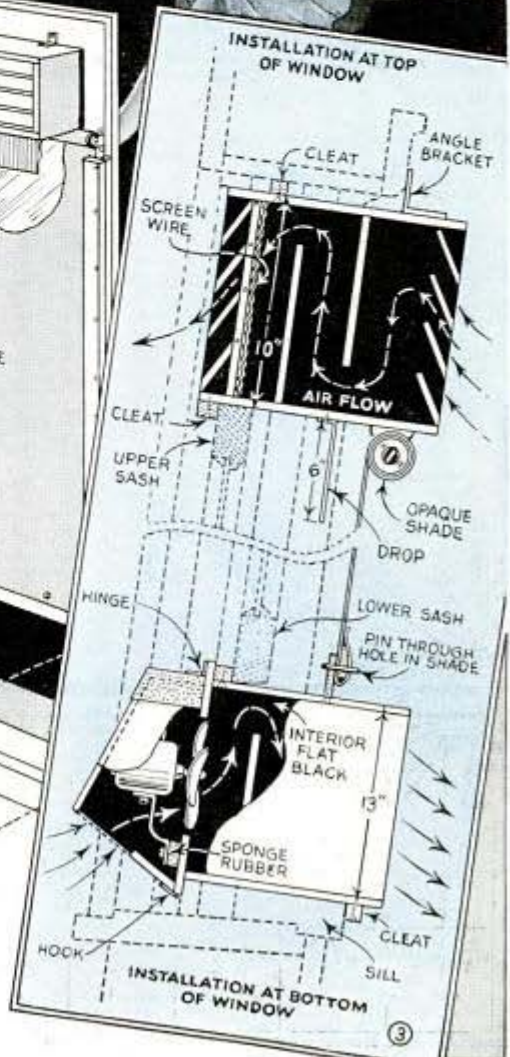
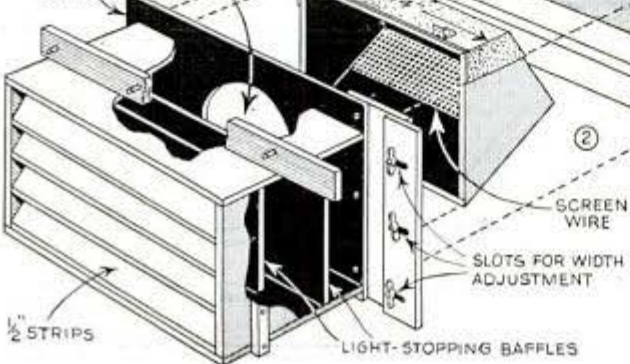

Model of U. S. Frigate

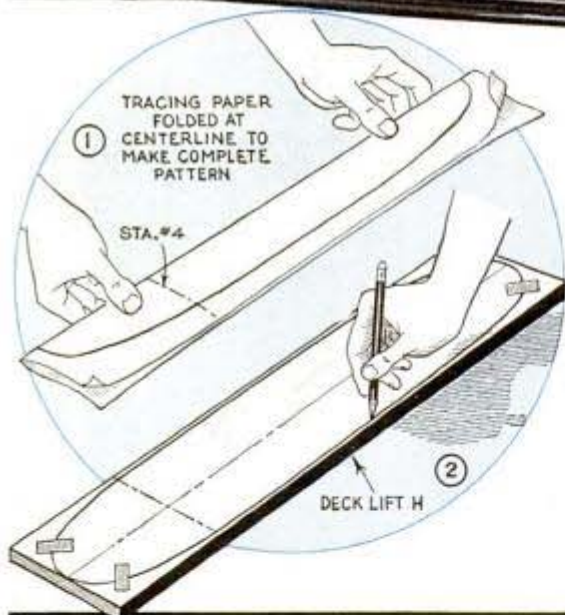
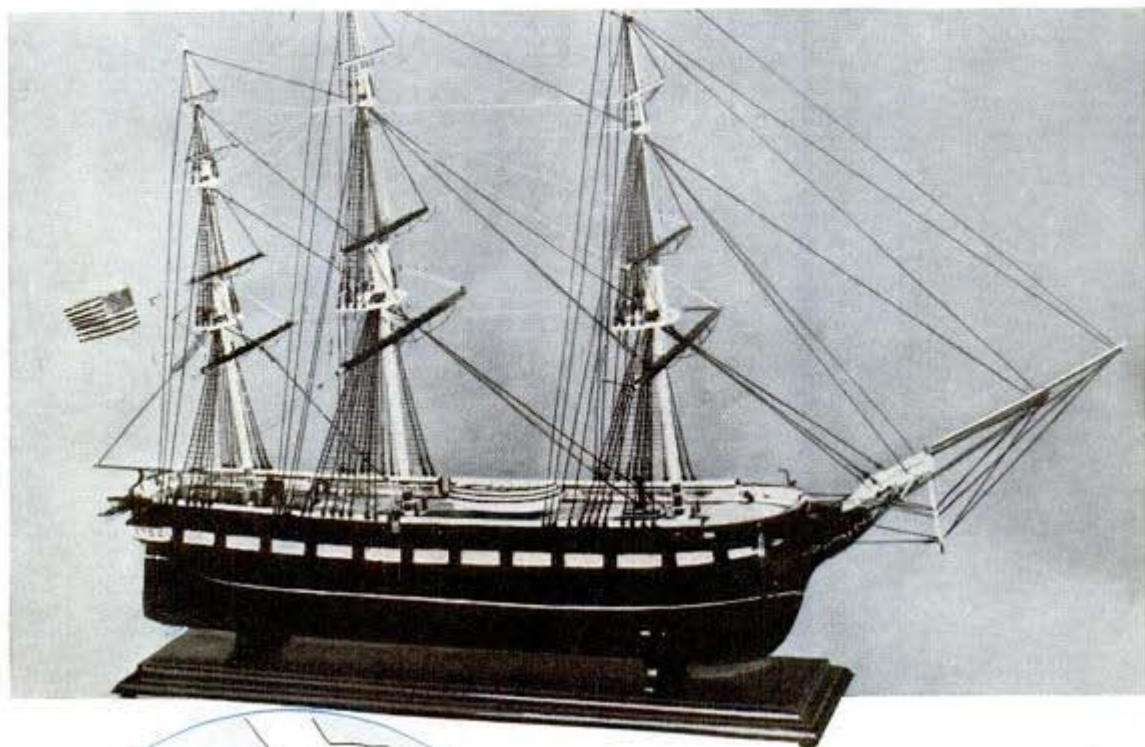

By H. W. POTTER

Part I—Building the Hull

WITH no difficult superstructure or ornate carving to overtax your patience, "Constellation" is a comparatively simple model to build. Its trim lines and striking coloring of black, white and gold make it a truly beautiful mantel piece.

To model this historic warship, you begin by making full-size paper patterns of the eight lifts or boards that form the hull. This is done by ruling paper in 1-in. squares and drawing in lines at points corresponding with the half-breadth patterns

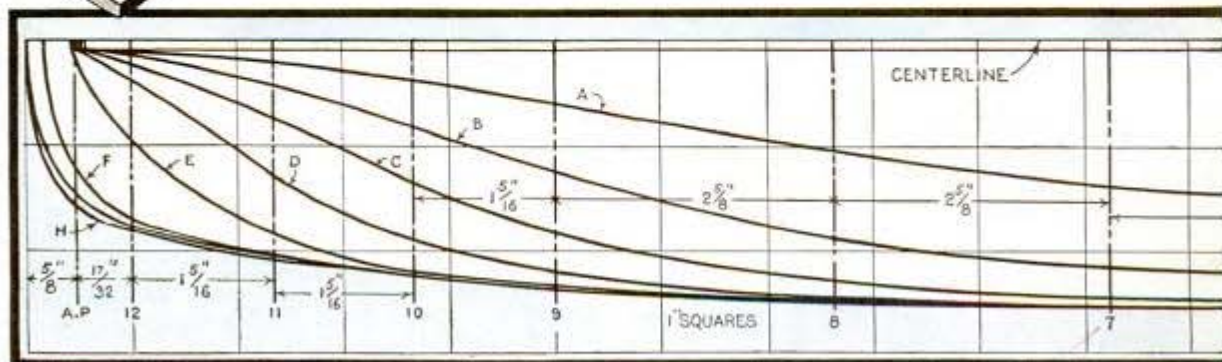

"CONSTELLATION"

Recommissioned in August, 1940, as a part-time flagship for administrative purposes, the historic frigate "Constellation" is now the oldest U. S. warship afloat. It was originally launched September 7, 1797, 45 days before the "Constitution," the only other survivor of the original six ships comprising the first U. S. Navy. Manned by a crew of 12 officers and 300 men, the "Constellation" was armed with 38 guns. It was rated at 1,265 tons, had a 40-ft. beam and a 163-ft. length from stem to stern. The cost of building this ship was \$314,212

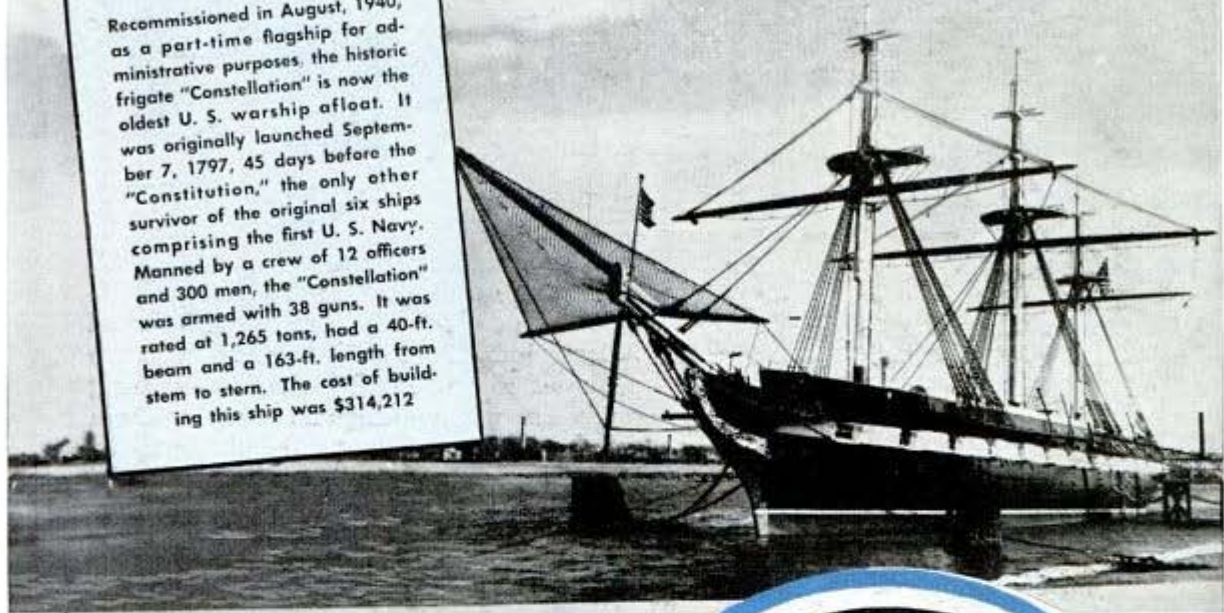

given in Fig. 3. Enlarge just half of each pattern in this manner, marking in station line No. 4, and then fold the paper at the center-line as in Fig. 1 to duplicate the opposite half. Of the eight lifts required, seven of them are of $\frac{1}{2}$ -in. clear white pine, the deck lift being cut from a piece of $\frac{7}{8}$ -in. straight-grain gumwood as this simulates closely the appearance of a weathered deck. In selecting the white pine be sure to see that it measures a full $\frac{1}{2}$ in. thick as the eight lifts must total exactly $4\frac{3}{8}$ in. when stacked together. Cut your wood into pieces measuring $5\frac{1}{2}$ by 23 in. and square station

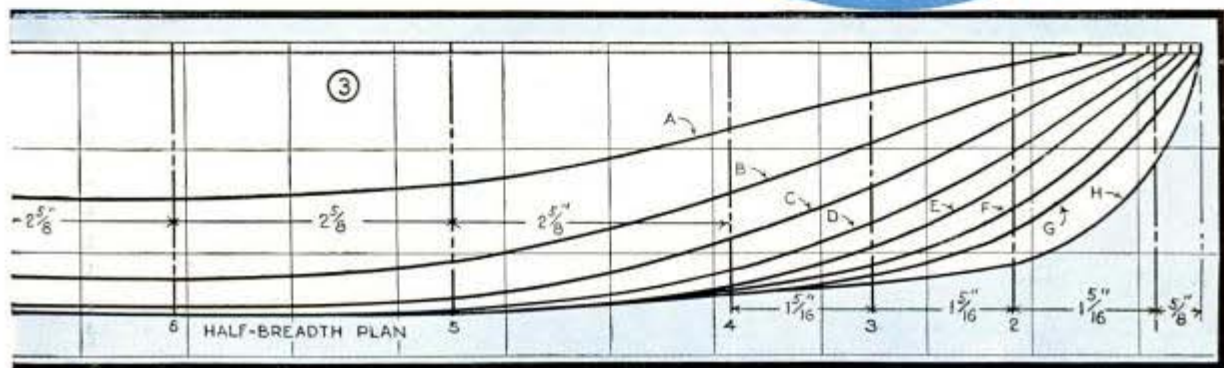

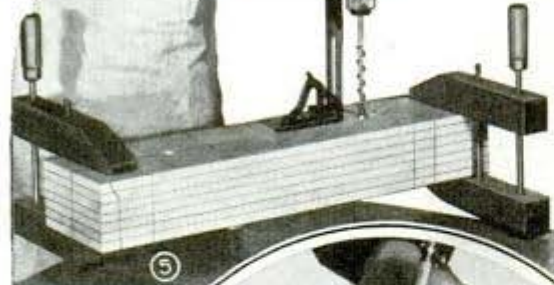
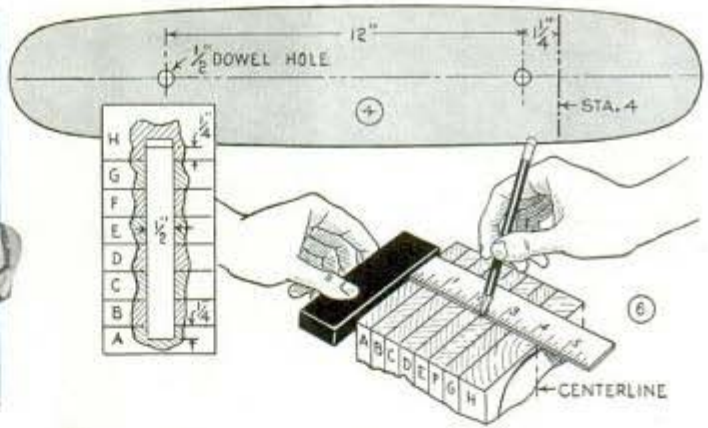

line No. 4 across the face of each. Next, you mark lift G with a centerline and locate the points for boring the two dowel holes as indicated in Fig. 4. The dowels are provided to prevent the lifts from shifting out of line when gluing and clamping them together. Letter the lifts alphabetically as indicated, stack the seven pine lifts and

clamp them together temporarily with a couple of handscrews. If you must bore the holes by hand, use a try square as in Fig. 5 to keep the bit running as straight as possible. Note in the cutaway detail of Fig. 4 that the holes enter lift A only part way. To bore corresponding holes in line in the underside of the deck lift, you clamp lift G to it and use the holes in the lift as a guide for the bit. After you have the lifts bored and fitted with dowels, run a centerline the length of lift

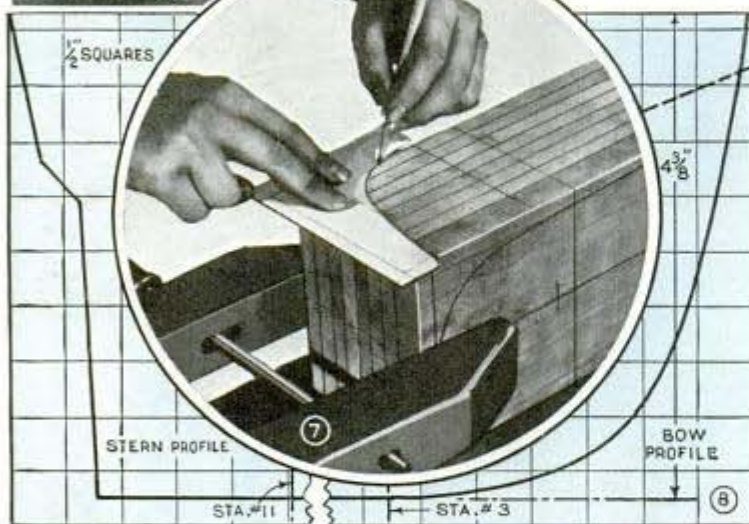

H, mark its shape as in Fig. 2 and square the centerline down each end of the stacked lifts as in Fig. 6. By locating the centerlines of the lower lifts in this manner instead of marking each individually beforehand, any error made in boring the holes straight will not offset the centerlines. Now, each lift can be marked for shape from its respective pattern. Center the patterns with the marks on the ends of the lifts and keep station lines No. 4 in register. After this, square all thirteen station lines across the top of lift H, spacing them as indicated in Fig. 3, and then extend Nos. 3 and 11 down one side. It will be easier to mark and cut the bow and stern profiles if you do it before sawing out the lifts, as a

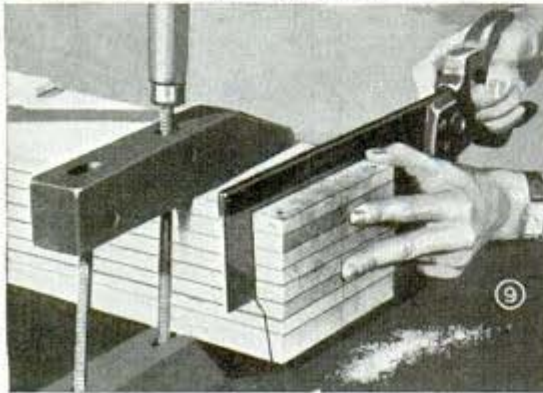

Differing from the usual procedure of shaping the bow after the lifts are cut to shape, here it is done beforehand so that the stacked lifts will provide a flat surface on which to mark the profile as in Fig. 7. The stern is shown being cut in Fig. 9

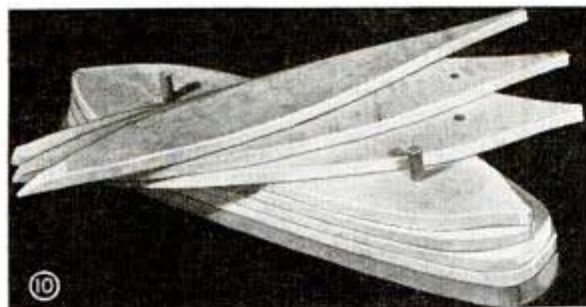

flat surface will be had to work from. Fig. 8 gives patterns for the profiles, although, if you wish, the bow profile can be obtained by tracing the full-size stem pattern in Fig. 23 and extending it to the top of the deck. (See Fig. 7.) The stern profile is placed even with station No. 11, while the bow begins at station No. 3. Both ends can be cut with a handsaw, the stern as in Fig. 9 and the bow by taking several tangent cuts and finishing with a wood rasp. The general contour of the hull is obtained by sawing each lift to shape as in Fig. 11 before gluing the lifts together. This is known as the bread-and-butter method of construction and simplifies greatly the carving of the hull. At this stage the hull should look like Fig. 10.

You are ready now to glue the lifts together. The dowels make it a simple job as there is no need to worry about misalignment of the lifts. The important thing here is to see that all contacting surfaces are evenly coated with glue and clamped tightly together as shown in Fig. 12. To assure a permanent job, use the new waterproof, resin-type glue. This comes in powder form for mixing with water,

The templates at the right give the correct rake of the mizzen, main and fore masts respectively and are used to check the slant of the bit in the manner shown below

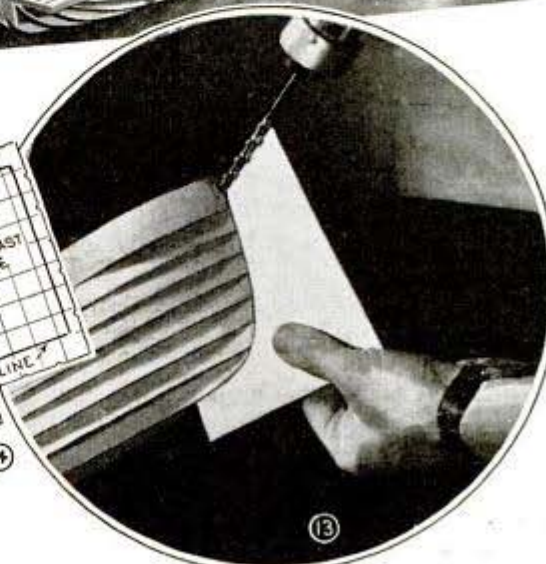
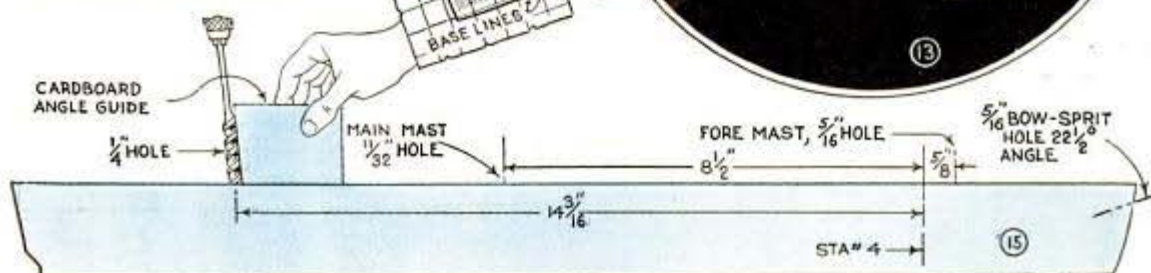

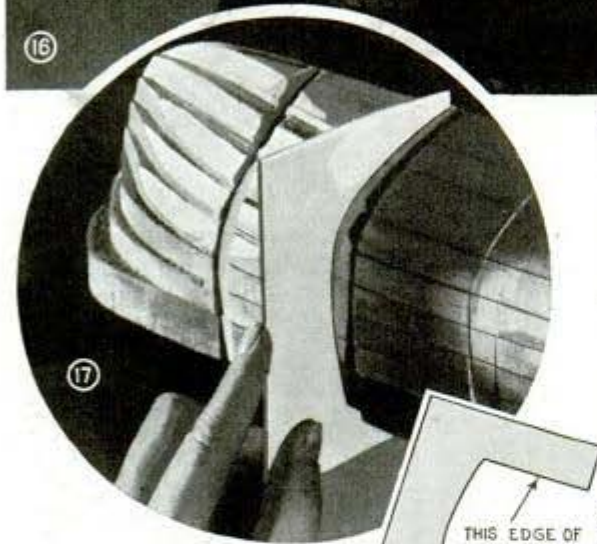
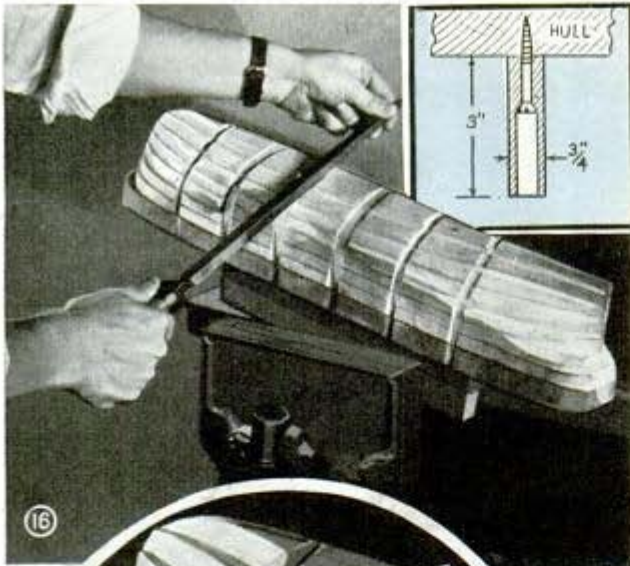

essary to make another template as you can use the original to check the angle as in Fig. 13.

Now make up a set of body templates or molds from the half breadths in Fig. 18. All thirteen of these, including the after perpendicular (A.P.), are given full size so that all you have to do is to trace each line separately on stiff cardboard or thin plywood. These lines represent what the hull would look like if it were sliced like a loaf of bread at each station line. Cut out each template carefully so that its outside shape will look like the one shown to the right of Fig. 17, and

and as the glue cannot be used after it stands, mix only an amount sufficient to do the work at hand. Allow the lifts to remain clamped over night.

If the mast holes are to be bored by hand, the templates given in Fig. 14 can be used to check the angle of the bit. It is best to bore them now while the deck is flat so that a try square can be used to plumb the bit laterally. The mizzen, main and fore masts have an aft rake or slant of 5, 3 and 2 degrees respectively and are located on the centerline in the position indicated in Fig. 15. The dotted line on the profile pattern (see Fig. 8) represents the point where the bow is bored for the bowsprit. It is not nec-

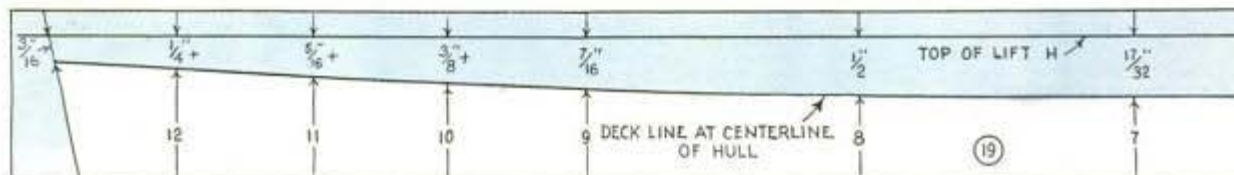
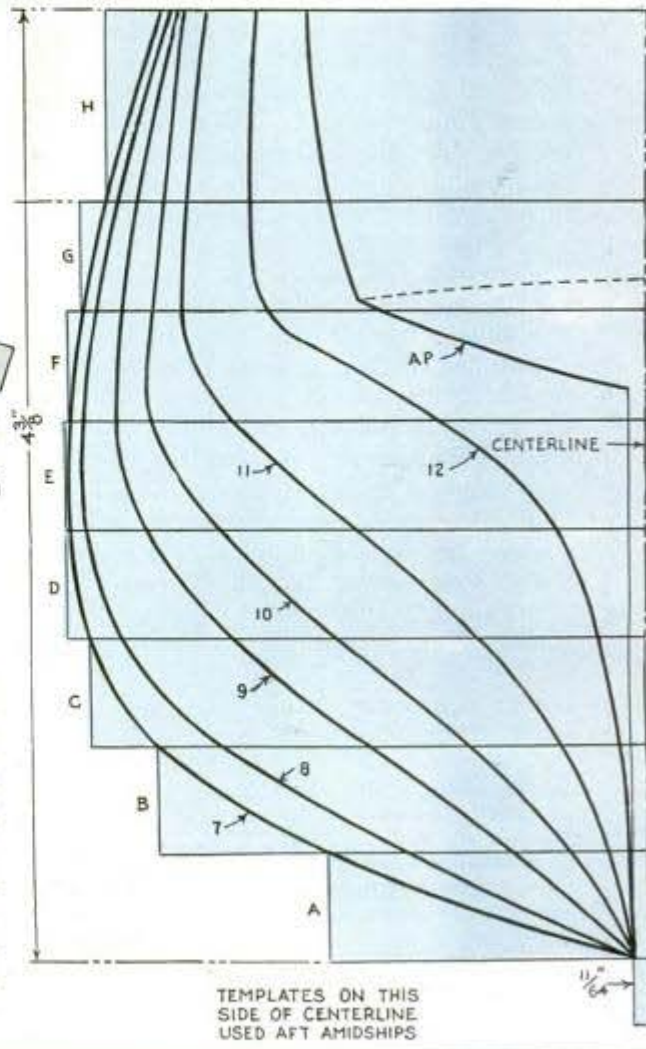

number it. To enable you to hold the hull upside down in a vise for carving, fit the deck with a clamping "keel" as shown in Fig. 16. If the screws are placed in the piece to enter the deck midway between the masts, the deck fittings will later cover the screw holes. Now, starting at station No. 7, for example, begin removing the waste with a coarse file as in Fig. 16. As you file, check the progress frequently with the body mold for that particular station as in Fig. 17. To obtain a true check each time, you must hold the top edge of the mold squarely and in contact with the top of the deck. When the contour of the hull begins to approach that of the body mold, work carefully to avoid filing too deeply. By rubbing the edge of the mold with graphite or blue chalk, you can tell quickly where the hull needs filing to make the mold fit perfectly. Proceed to work the hull down

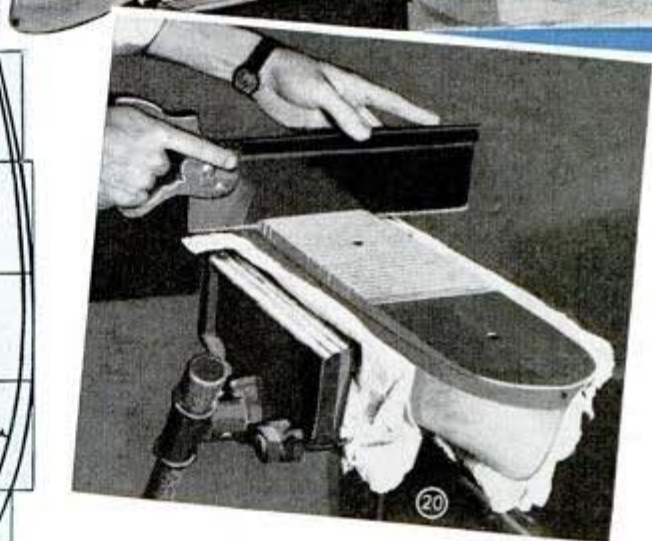
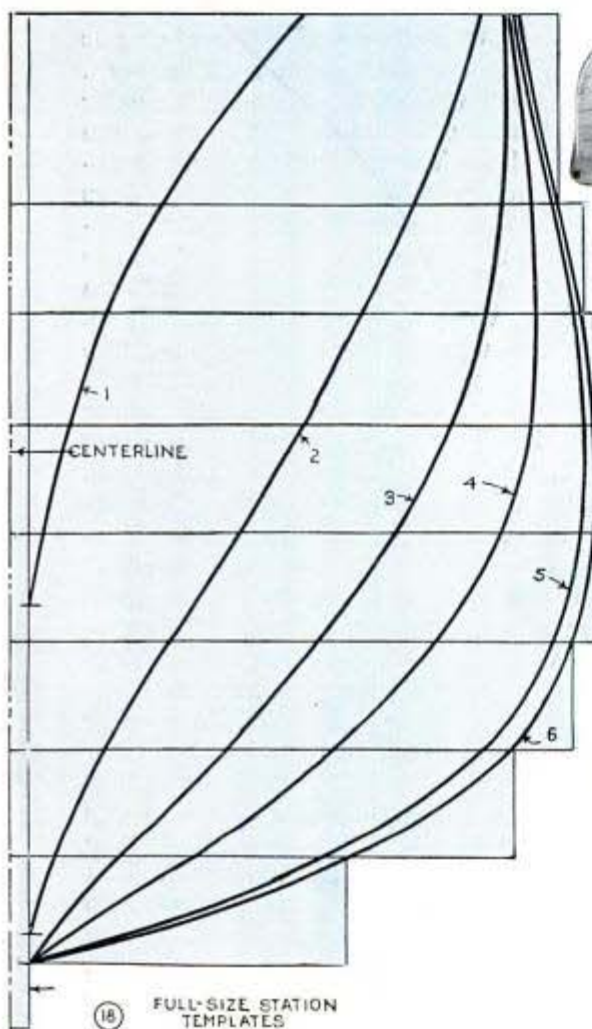

at stations 5 to 10 inclusive as in Fig. 16 until the leading edge of the mold meets the deck centerline, and then with a small block plane, remove the waste between the grooves. The shaping of the bow and stern requires the use of a half-round file and a gouge to cut the flare. Be particularly careful in shaping the bow so that you do not spoil the rounded end of the top lift by filing beyond the edge. Also, do not bring the bow or stern to a decided point, but leave a flat

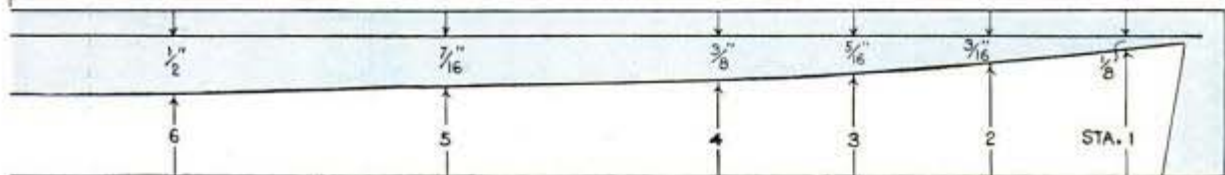

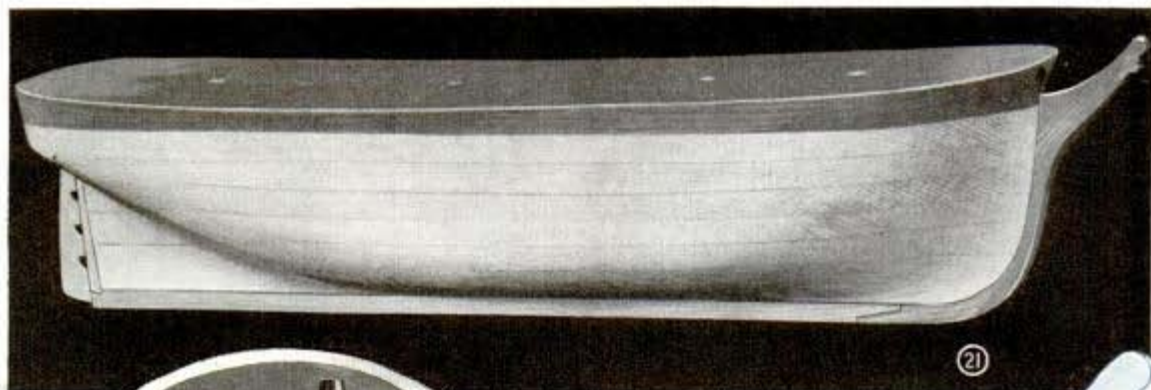

FULL-SIZE PATTERNS
OF STEM AND RUDDER

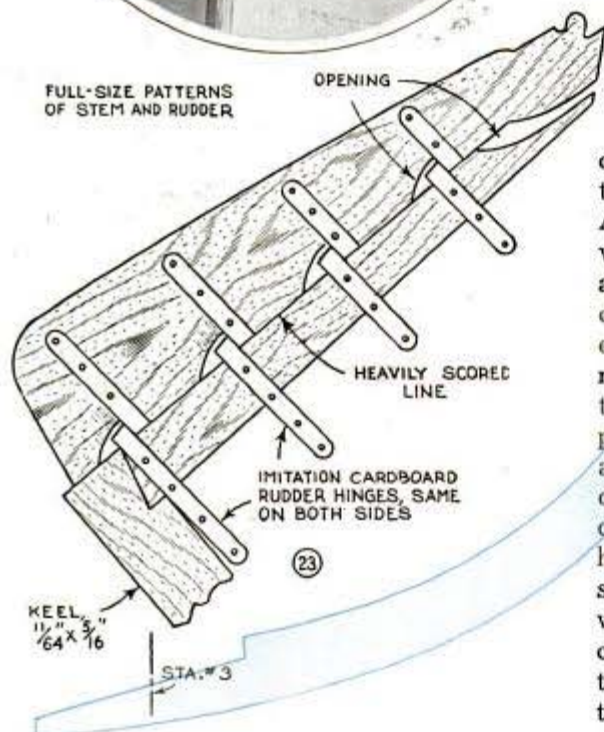

By placing carbon paper under these full-size patterns of the rudder and stem, or thin paper over the top of them, you can trace their exact shape either directly to the wood, or first to cardboard. Use hardwood, especially for the stem, and drill pilot holes for the brads to avoid splitting the pieces in attaching them. The rudder and its post are made to look like two separate pieces by scoring each face

spot for attaching the stem and rudder. Final shaping and sanding of the hull at these points is done after the stem and rudder have been attached.

With the hull carved, the next step is to curve the deck from bow to stern. Before you do this, however, transfer the position of the station lines to the side of the hull so that they can be re-marked on the deck later. Fig. 19 shows the amount to be removed at each station line. An easy way to do this is to kerf the deck with a handsaw as shown in Fig. 20. Make saw cuts about $\frac{1}{4}$ in. apart to a depth slightly above the guide lines marked on both sides of the hull, and then chip away the wood with a chisel. Follow this by planing across grain to bring the deck down to the right depth. After you have the deck curved lengthwise, it is crowned $\frac{1}{16}$ in. laterally. For this, a cardboard template will be needed to check the crown as you slope the deck each way from the centerline with a cabinet scraper. With this done, re-establish the station lines on top of the deck. Complete the hull by adding the stem, rudder and keel as in Fig. 21. Both stem and rudder are given full size in Fig. 23 for tracing directly on the wood. It is best to use hardwood for these parts, especially the stem as most of this is cross grain. You will notice that the rudder and its post are cut from one piece but made to look like two separate pieces by scoring the wood at the point indicated. Brads and glue are used to attach the parts as shown in Fig. 22, after which the keel is fitted between the two. The false hinges which pass through the openings in the rudder and glue to each side, are attached after the final sanding of the hull.

(To be continued)

POPULAR MECHANICS

Three-Tray Table on Casters Has Many Uses

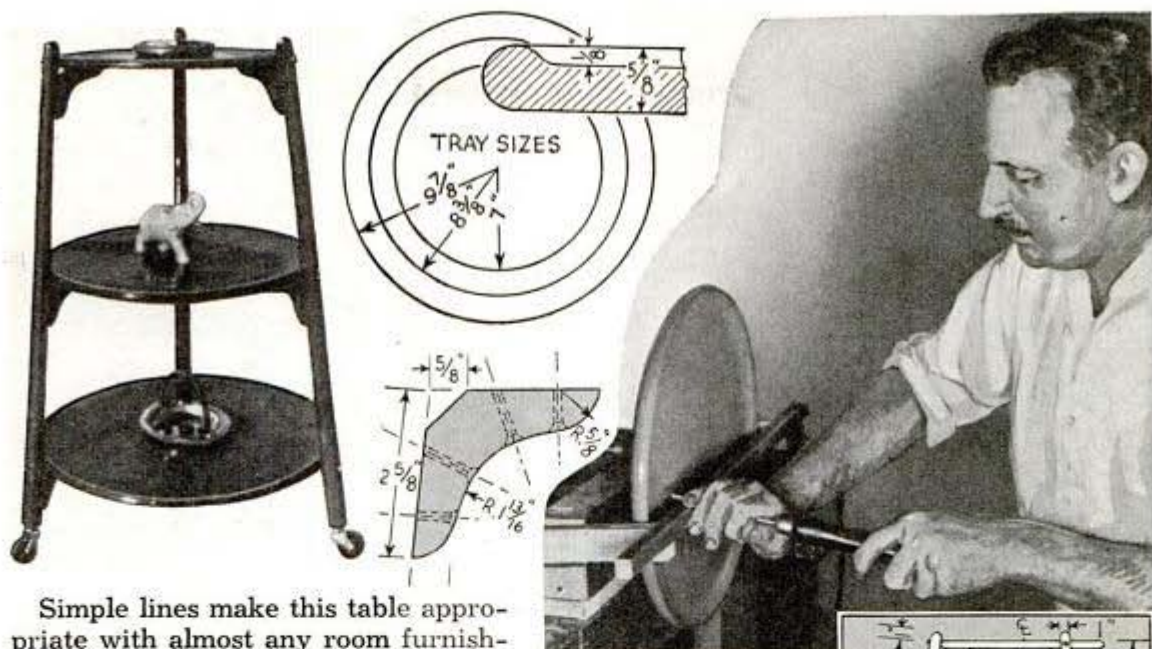

Simple lines make this table appropriate with almost any room furnishings, and its versatility makes it almost indispensable to the busy hostess. Normally, it serves as a lamp or bric-a-brac table. But it is always handy for serving a light snack to a few guests after an evening of cards, as its casters permit it to be rolled to the kitchen where its ample trays are filled and returned to the guest room. Then for large gatherings, it can be pressed into use as a tea cart or serving table. Any hardwood can be used in making the table. The original was turned from basswood and stained a red maple, after which three coats of varnish were applied, allowing a few days between coats. The last coat was rubbed with rottenstone and oil followed by an oil polish.

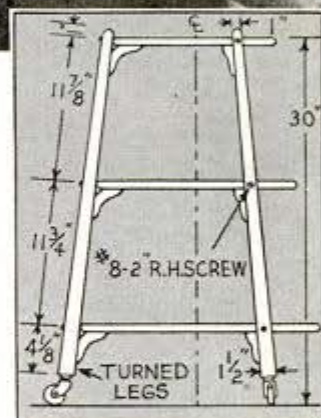

Paint-Locked Sash Loosened With Block and Hammer



If you can't loosen a newly painted window sash by cutting through the film of paint in the corner between the sash and frame, and it seems that some paint has run between the two, try this method. Set a small hardwood block endwise against the sash frame close to the top and strike it lightly with a hammer. Continue the procedure all the way across the top and down the sides of the sash frame. The hammer blows will break the paint film so that the sash can be opened without breakage.

YOUR IDEAS ARE WORTH MONEY

Popular Mechanics pays readers cash for ideas that are accepted. Have you a shortcut that will save other readers time and money? Then don't fail to send it to the Homecraft Editor. Include a short but complete description and a clear photo or sketch. If usable, we will mail you a check.

Fresh VEGETABLES



Courtesy National Garden Bureau



By James R. Ward

BY GROWING your own vegetables, you not only save money, but you have crispy, tasty ones for your table. You don't need a farm to do it either. Even some plants such as strawberries, will grow and produce in a barrel, Fig. 12. Just a few hundred square feet of ground in your yard will do. Figs. 3, 5, 6 and 7 show different ways of converting an average yard into a vegetable garden without detracting from the appearance of the grounds. If a vacant lot is available, you can produce enough vegetables for your table and have plenty left over for canning.

Selection of the plot is very important. If weeds, grass or other vegetation grow luxuriantly on the ground, it will grow a good garden. It is just a waste of time and labor to plant a garden where there is rock a few inches under the soil, or where a fill has been made with



2

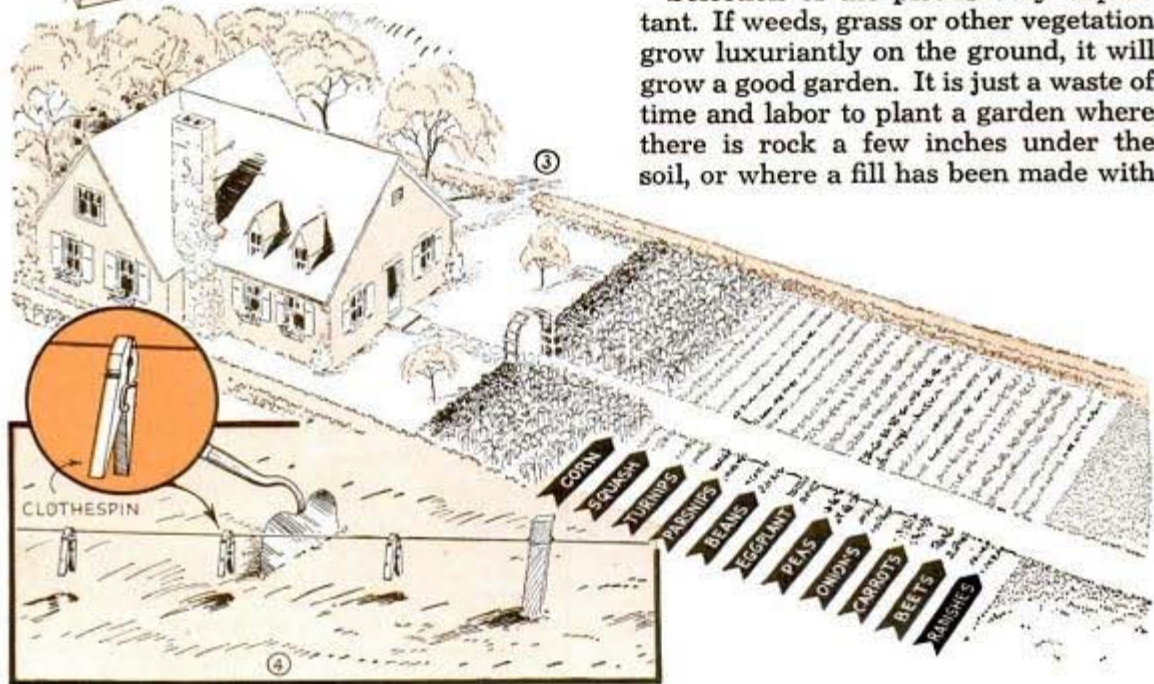

3



CLOTHESPIN

4

at your BACK DOOR



Courtesy Peter Henderson & Co.

cinders, broken brick, stones, etc. The ideal soil is a dark, sandy loam. Do not locate your garden under or near large trees that will steal the moisture and plant food from the crops.

After selecting the plot, you are ready to prepare the soil. Spade or plow it 6 to 10 in. deep. If possible, turn under manure. Leaves and other dead vegetation are also good. Their value as a fertilizer is nominal but they supply humus to help retain

moisture. If the ground is of a clay type, sifted coal ashes worked well into the soil will tend to loosen it. So will wood ashes. Those from soft woods add little food value but most hardwoods contain potash and lime, which are good fertilizers. When natural fertilizers are unavailable, you can use the commercial type at planting time. Before using these, it is a good idea to test the soil so that you can use the food elements needed; a few samples of the soil

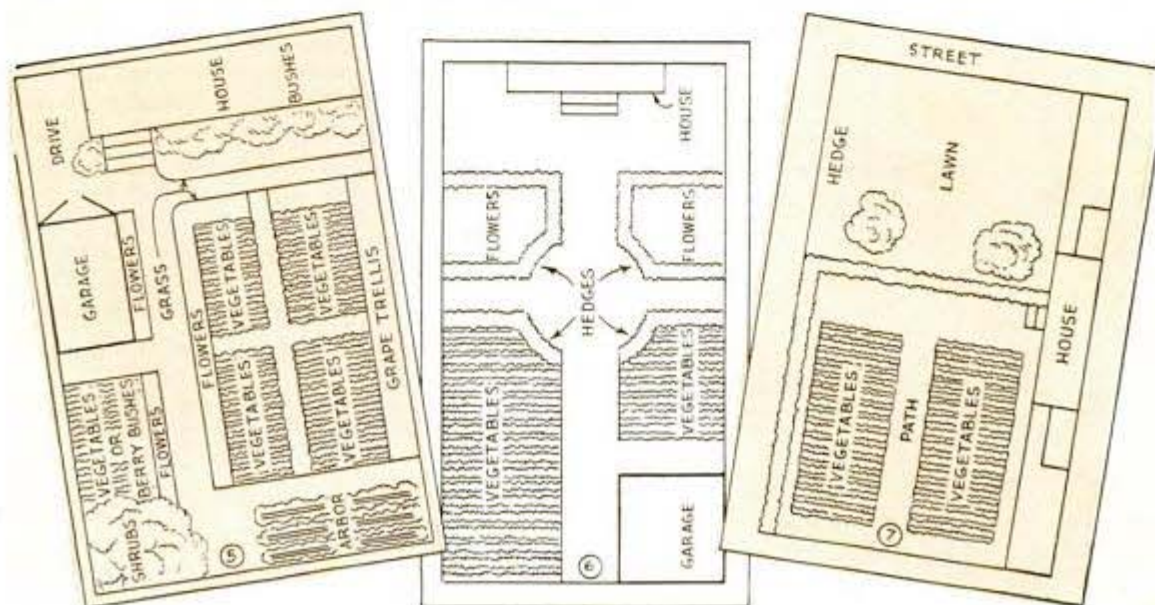



can be sent to your local seed company, or to the state agriculture college or university.

Next comes the selection of the seeds and planting. What vegetables to plant will depend on the space available. On a small plot, it is best to avoid those that take considerable space such as corn, cucumbers, etc. However, some vegetables that mature early can be resown in the same ground to have a succession of them, or they can be followed by others in the same space as indicated in the table of Fig. 15. Half the pleasure of a garden is having something to use just as early in the spring as possible. To do this, seeds are started early and then transplanted in the garden after danger of frost is past. Truck gardeners start theirs in hotbeds, but the home gardener who needs only a few of

each kind can start them indoors in window boxes or flats, Fig. 1. The flats should be kept in a south window and the temperature should be maintained over 60° F. Tomatoes, cabbage, peppers, eggplant and lettuce can be started this way and then transplanted later. The seeds are sown thickly in tiny drills and transplanted to another flat in small hills after they



have grown to a height of an inch or so, Fig. 2. The plants mentioned above can usually be purchased locally, but it is fun to grow them yourself. Other vegetables that do not permit transplanting in the usual way, can be started early if the seeds are sown in individual containers such as ice-cream cartons, flowerpots or berry boxes, Fig. 8. In transplanting, be careful not to disturb the root system. Cut the container away and set the entire contents in the ground. Perhaps the best way for the small gardener is to have six to twelve containers of each vegetable started indoors for early use, and then start the rest of the garden in the usual way by sowing seeds in the ground or by purchasing the seedlings.

Vegetables are divided into about four groups as to planting time. Early cabbage,



kale, onion sets, peas, potatoes, spinach and radishes may be planted two weeks before the average date of the last killing frost. Beets, Swiss chard, carrots, lettuce, peas, cauliflower and sweet corn should be planted about the date of the last killing frost; while beans, parsnips, salsify, cucumbers and tomatoes should not be planted for at least a week after frost. Heat-loving plants, such as peppers, eggplant, Lima beans, etc., should not be planted until the ground is thoroughly warm.

As soon as the weather permits, work down the ground, which has already been spaded or plowed, and prepare it for planting. Use a garden rake and pulverize the soil finely. If you are using commercial fertilizer, work it into the ground as you prepare the seed beds. If you want to conserve the fertilizer, work it into the soil only where the seed rows are to be made or where seedlings are to be transplanted. In general follow the directions in your seed packets. Use a guide line to make straight seed furrows. Fig. 4 shows a good marker to get uniformity in rows of vegetables that are planted in hills.

Seedlings that have been transplanted must be protected from the sun for a few days. Fig. 11 shows a good way to do this. When transplanting seedlings wrap paper around the stems as in Fig. 13. This will keep cutworms from killing them. If your garden plot is unfenced, a coil spring to shield each transplanted seedling, as in Fig. 14, will keep dogs or cats from breaking them off. If you have only a few seedlings, a tin can buried beside each one when it is transplanted, Fig. 10, will enable you to water it easily during dry weather. Or, you can mulch each one with an old magazine or newspaper, Fig. 9, to retain the moisture in the ground. Also, mulching of entire small plots can be done by laying heavy paper between the rows and weighting it with a little soil.



15

PLANTING TABLE			
Kind of Vegetable	Planted	Bears Until	Replaced by
Beans, pale and lima . . .	Late May	Frost	
Sweet Corn, late or main crop . . .	Mid-May	Sept.	Pumpkin and vine Squash planted in corn rows by mid June will succeed the corn
Sweet Corn, mid-season varieties . . .	Mid-May	Mid-Aug.	
Sweet Corn, early varieties	Mid-May	Early Aug.	
Tomatoes, set from hotbed	Late May	Frost	
Peas, late or main crop varieties	Apr. or May	Early Aug.	Rutabaga and late Turnips
Peas, early and mid-season varieties	Apr. or May	Mid-July	Celery from seedbed
Beans, dwarf or bush varieties	Mid-May	July	Cabbage and Cauliflower from seedbed
Lettuce and Endive	Apr. or May	Mid-July	Beets for fall and winter use
Cabbage and Cauliflower	Apr. or May	Aug.	Beans, dwarf or bush varieties
Kohlrabi, 1/2 row; Swiss Chard	Apr. or May	Aug.	Lettuce and Endive
Carrot and Turnip, early varieties	Apr. or May	Aug.	Chinese Cabbage and Florence Fennel, from seedbed or sown in Radish row will occupy the three rows
Radish, Mustard and Cress	Apr. or May	July	
Onion Sets	Apr. or May	Aug.	Spinach for fall use
Beets, early varieties	Apr. or May	Aug.	Carrots 2/3 row; winter Radish
Spinach	Apr. or May	Mid-June	
Eggplant and Peppers	Late May	Frost	
Beans, bush lima	Late May	Frost	

Garden-Marker Line Tightened And Anchored With One Stake

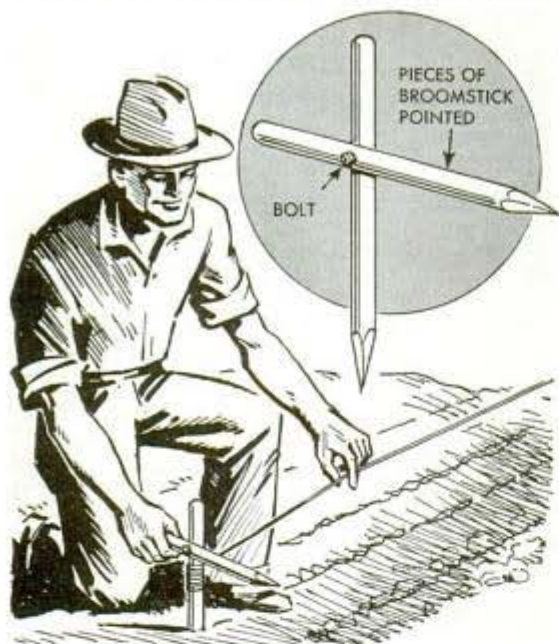

Pointed at the ends and pivoted together with a small bolt, two lengths of broomstick provide a handy stake unit with which a garden-row marker can be tightened and anchored easily. The line is wrapped around one stake, which is then pushed into the ground. Then the other stake serves as a handle to turn the one in the ground and tighten the line, after which the handle is tilted to engage the ground and prevent the assembly from turning to loosen the line.

Centrifugal Paint-Brush Cleaner Used in a Drill Press



as indicated and lowered into a pan of cleaner, after which it is slowly swished

Cleaning of a paint brush can be done quickly if you use this simple centrifugal jig, which is rotated in a drill press. It consists merely of a small C-clamp welded or riveted to a short rod of a size to fit in the drill-press chuck. In use, the brush to be cleaned is held in the clamp

around by pulling on the drill-press belt. Then the brush is raised to clear the cleaner, and the drill press is turned on to rotate it rapidly. This throws out the cleaner and dissolved paint by centrifugal force, after which the operation is repeated. A fairly deep container is necessary so that both operations can be carried on inside it.

Lead Weights Hold Wood Batten For Drawing Accurate Curves

Accurate curves may be drawn by ship-builders' methods in which lead weights and close-grained flexible wood or celluloid battens are used as indicated. To cast the weights, first make a pattern of pine, tapering all sides to facilitate removing it from the mold; give it two coats of shellac and sand smooth. Next make a wood flask about 1 in. larger than the pattern and roughen the sides or drive nails in them to hold the plaster. Now brad a small cleat



to the bottom of the pattern, oil it and fasten in the center of the flask. Fill the flask slowly with plaster-of-Paris mixed to a rather stiff consistency and when it has hardened, turn a screw eye into the bottom of the pattern and lift it out. For the hold-down point on each weight, bend a 10d nail

slightly at both ends and nail a cleat on the flask temporarily to hold it in place as shown. Cover the mold surface with graphite, melt lead, 2 lbs. or more, remove the slag and pour it into the mold slowly. When cold, remove the weight, file or sand the rough edges and glue felt on the bottom. Finishing touches consist of giving the weights two coats of shellac and filing or grinding the nails to a spur point.

—Charles A. King, East Kingston, N. H.

Burning-Out of Flashlight Bulbs Avoided by Warning Disk

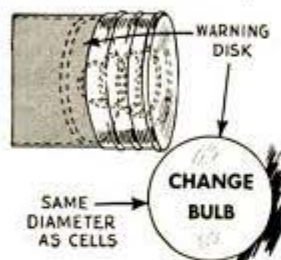

If you carry an extra flashlight bulb of lower voltage than the regular one to use when the battery weakens, a warning disk put in the bottom of the case

will prevent you forgetting to change to the stronger bulb when putting in a new battery. The disk should be metal and is placed on the bottom of the lower dry cell. Any lettering desired to serve as a warning can be printed on the disk.

—W. C. Wilhite, Carlinville, Ill.

Hot Potatoes Are Peeled Easily With Strawberry Huller

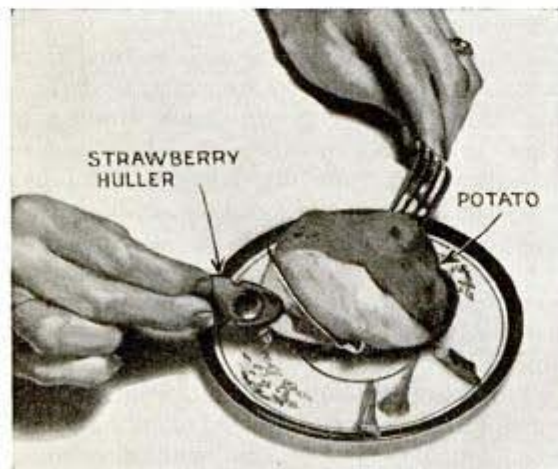

When potatoes are boiled in their "jackets," a strawberry huller is just the thing with which to peel them while they are hot without burning the fingers. Steady the potato with a fork and use the huller as indicated.

Small Flag Warns Pedestrians Of Hose Across Sidewalk



Next time you have to run a garden hose across the sidewalk in front of your home when watering the lawn, why not set a small red flag on the walk near it to warn pedestrians and possibly avoid an accident? It takes only a few minutes to make a handy flag for this purpose from a piece of red cloth and a length of heavy wire bent as indicated.

'Ice Bag' Keeps Can of Milk Cool While on Way to Market

One dairyman keeps his milk or cream from souring while hauling it to market by suspending an ice-filled container inside of each can. The bag is a length of inner tube, cemented together at one end and tied with a string at the other, the string being long enough to project up past the cover, which holds the ice container suspended in the can, as shown.



STURDY DINETTE SET



Substantial table has pull-out ends to permit insertion of extra leaves, and the ladder-back type chairs have leather or rawhide seats

HERE is an extension table and set of chairs especially designed for those who have a small dining room and would like furniture of a rather rustic type. Construction of these pieces is relatively simple and the whole set can be made with a few hand tools. Both ends of the table slide out so extra leaves can be added. Almost any kind of wood can be used, even white pine, although hardwood is more durable and provides greater rigidity.

The table legs are cut from square stock and tapered slightly toward the top. While lag screws are used for securing them to the leg crossrails, both end stretchers are mortised, glued, and dowel-pinned. Before fastening the top permanently, the upper edges of all boards are chamfered to form V-grooves when assembled. Both extension ends are mounted on slides that permit the ends to be pulled out so that room is provided for two 10-in. leaves. Dowel stops near the end of each slide prevent the extension ends from being pulled clear out.

Like the table legs, all chair legs are cut from square stock after which the corners are rounded. If a lathe is available, tops of the chair-back uprights can be turned as indicated, or they may be tapered slightly and finished off square. Also, the rungs may be shaped from square stock, using hand tools to round the corners and taper the ends, which are forced into holes bored in the legs. Strips of 1/2-in. rawhide that make up the seats in basketweave pattern, are stapled on the inside of the seat rails, each strip being carried across the top of the rails twice.

Finishing the set is a matter of preference, but if an open-grained wood has been used, such as mahogany, walnut or oak, the pores must be filled with a prepared paste filler of the proper color. After the filler has been wiped off and has hardened, the work is sanded lightly and dusted, after which shellac and wax or several coats of high-grade varnish are applied, if a natural finish is desired.

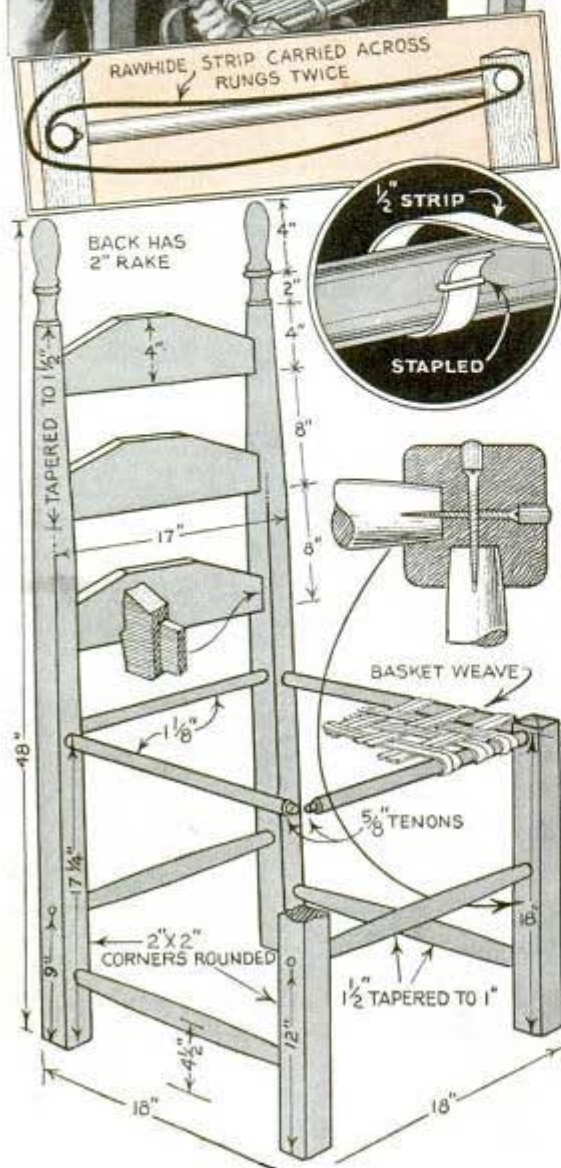

100 W.P.

built with hand tools...

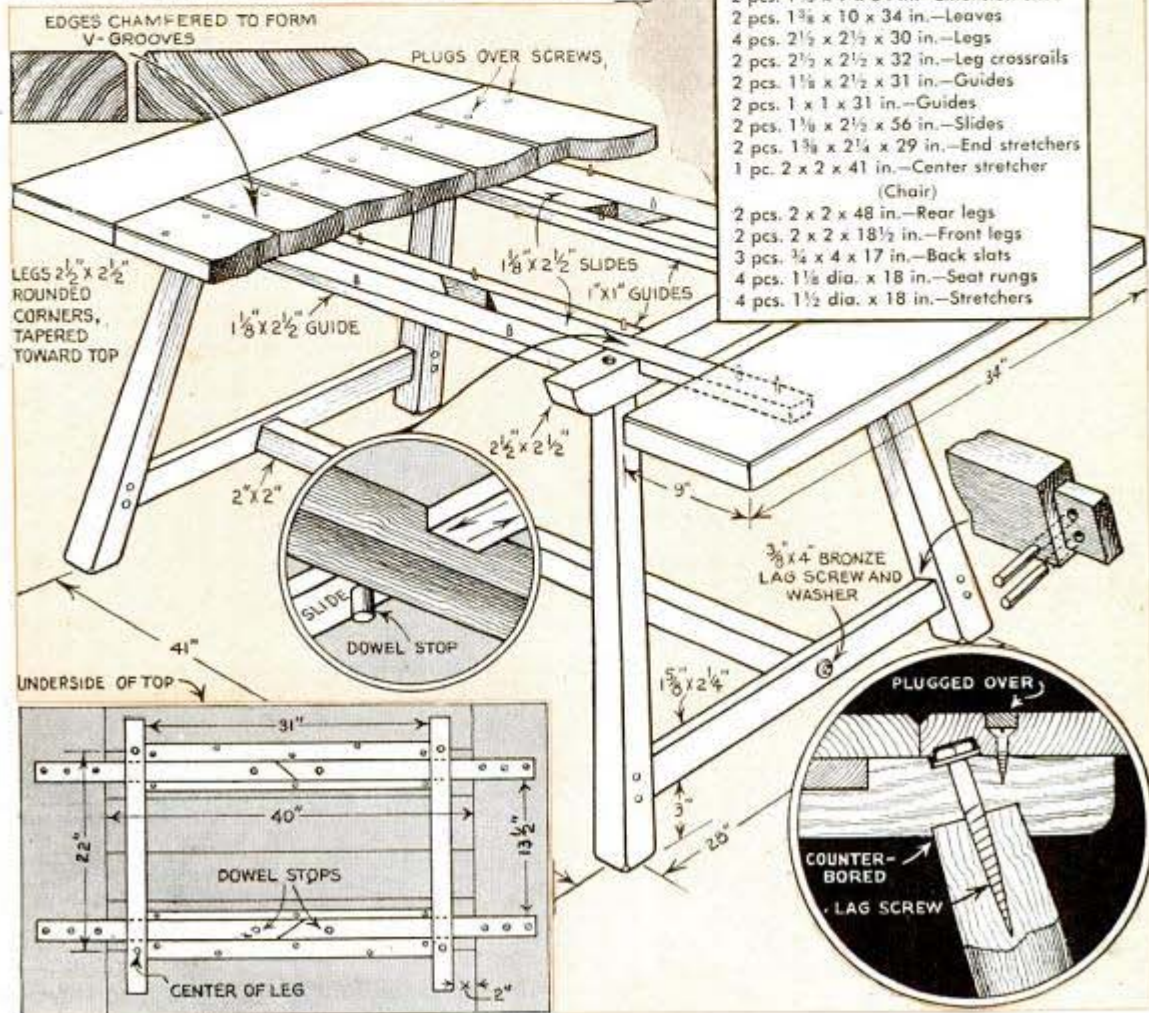
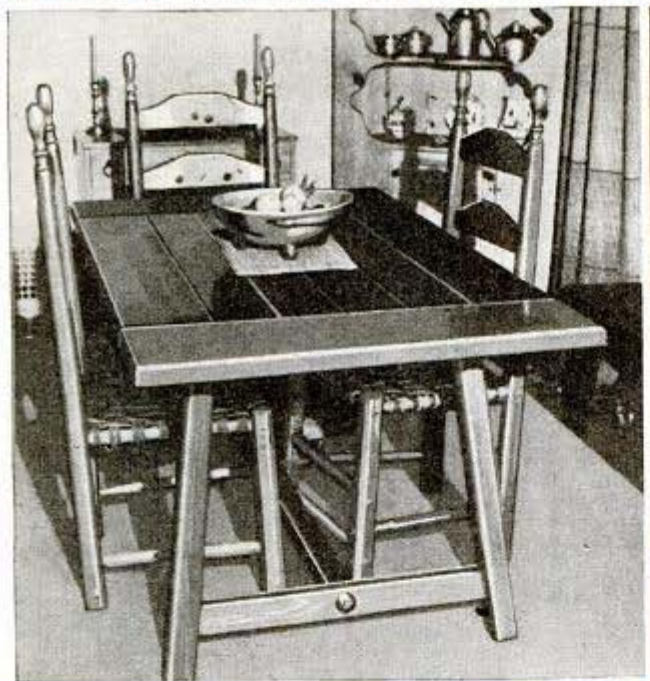

MATERIAL LIST

(Table)

- 2 pcs. 1 7/8 x 7 x 40 in.—Top center
- 4 pcs. 1 7/8 x 5 x 40 in.—Top center
- 2 pcs. 1 3/4 x 9 x 34 in.—Extension ends
- 2 pcs. 1 3/8 x 10 x 34 in.—Legs
- 4 pcs. 2 1/2 x 2 1/2 x 30 in.—Legs
- 2 pcs. 2 1/2 x 2 1/2 x 32 in.—Leg crossrails
- 2 pcs. 1 1/2 x 2 1/2 x 31 in.—Guides
- 2 pcs. 1 x 1 x 31 in.—Guides
- 2 pcs. 1 1/2 x 2 1/2 x 56 in.—Slides
- 2 pcs. 1 3/4 x 2 1/4 x 29 in.—End stretchers
- 1 pc. 2 x 2 x 41 in.—Center stretcher

(Chair)

- 2 pcs. 2 x 2 x 48 in.—Rear legs
- 2 pcs. 2 x 2 x 18 1/2 in.—Front legs
- 3 pcs. 1/2 x 4 x 17 in.—Back slats
- 4 pcs. 1 1/2 dia. x 18 in.—Seat rungs
- 4 pcs. 1 1/2 dia. x 18 in.—Stretchers

Shield Keeps Child's Fingers Out Of Sewing-Machine Handwheel



To prevent small children from getting their fingers in the handwheel of a sewing machine while it is running, bend a shield from a piece of sheet metal as shown so that it can be slipped on or off the machine easily. A strip of felt glued on the underside will prevent scratches on the cabinet.

Diameter of Cylindrical Work Measured With Steel Squares

The diameter of large cylindrical work can be found by using two steel squares as indicated. When the tongue of one square is at right angles to the blade of the other, the reading on the inner scale of either square will give the diameter of the cylinder.

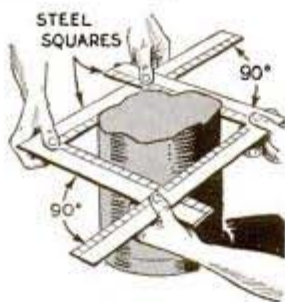

Electrical Snap Connectors For Model Railroad

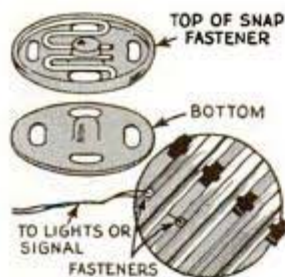

I find that dress snap fasteners make ideal electrical connectors for use on model-railroad systems. With them, electrical connections are made or bro-

ken easily and quickly. One part of the fastener is soldered to the rails or other place where connections are to be made, and the other part is soldered to the lead wire of lights, signals or other accessories. For good electrical contact, use plain metal fasteners, not enameled ones.

—Richard Sklenar, Tekamah, Nebr.

Saw Blades in Transparent Case Selected at a Glance

Selecting a saw blade from this case is just a matter of turning the hole in one end to the group of blades desired and pulling out one. The case consists of a piece of round soft wood, such as a window-shade roller, which is grooved around the sides to provide receptacles for the blades, and a celluloid cylinder. The latter is made by cutting a piece of clear celluloid to size and cementing the edges together with acetone. Tin disks over the ends close the blade receptacles, one being drilled and pivoted so that it can be turned to remove the blades.



Yarn Wound on Cake Rack to Dry After Steaming It

After steaming yarn to remove the kinks, when it has been unraveled from a knitted garment, wind it on a wire cake rack. It is much easier to handle in this way, and the rack can be hung up with a clothespin, permitting the yarn to dry thoroughly.

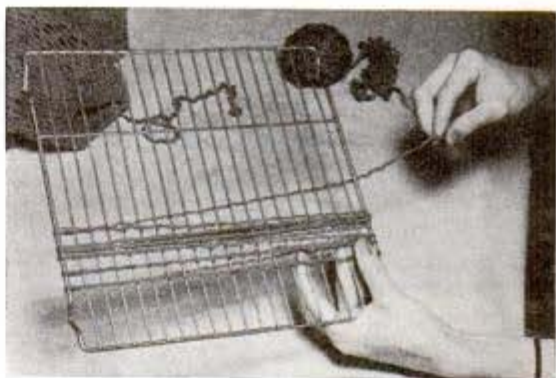

BEFORE YOU BUY A HOUSE



"Lay of the land" is the first thing to look at outside the house. Next, the walls should be carefully inspected for defects from cornice to grade. Finally, details such as gutters, roof flashing and the condition of the shingles

By W. Clyde Lammey

Part II

AFTER you have examined the interior of a house, noticing carefully the condition of ceilings, walls, floors, plumbing and heating equipment, and basement walls, you should make a detailed inspection of the outside in much the same way. Jot down your findings in your note book. This data is especially helpful if you are looking at a number of houses, which means you will have to decide on a basis of carefully weighed advantages and disadvantages.

The first thing to notice outside is, literally, the "lay of the land." It's very important, too, for it may mean the difference between a well-drained location and a "sump" or low spot. The latter may be the cause of such recurring troubles as sluggish drainage after prolonged rainfall, sinking sidewalks, flooded storm sewers, steady seepage through basement walls, undue settling of the foundation, etc. Such things have a very definite bearing on resale value of the property, also. This point always should be kept in mind, for the cost of remedy added to the initial cost may mean a total investment considerably above the market value of the property.

So, look up and down the street, across the street and back in the alley—if there is an alley. Note carefully the slopes to or from the location. If the house is near or on the crest of a hill or even a

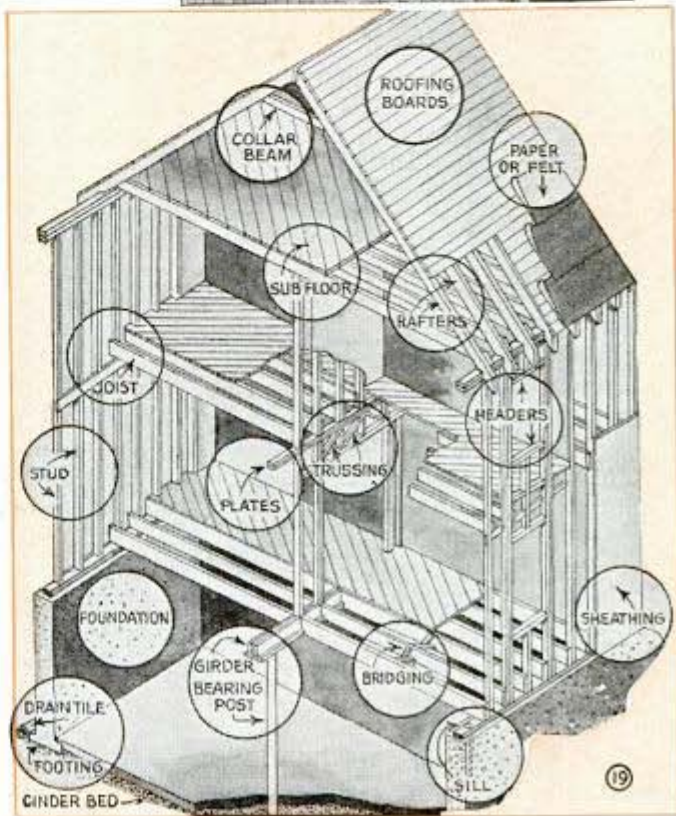

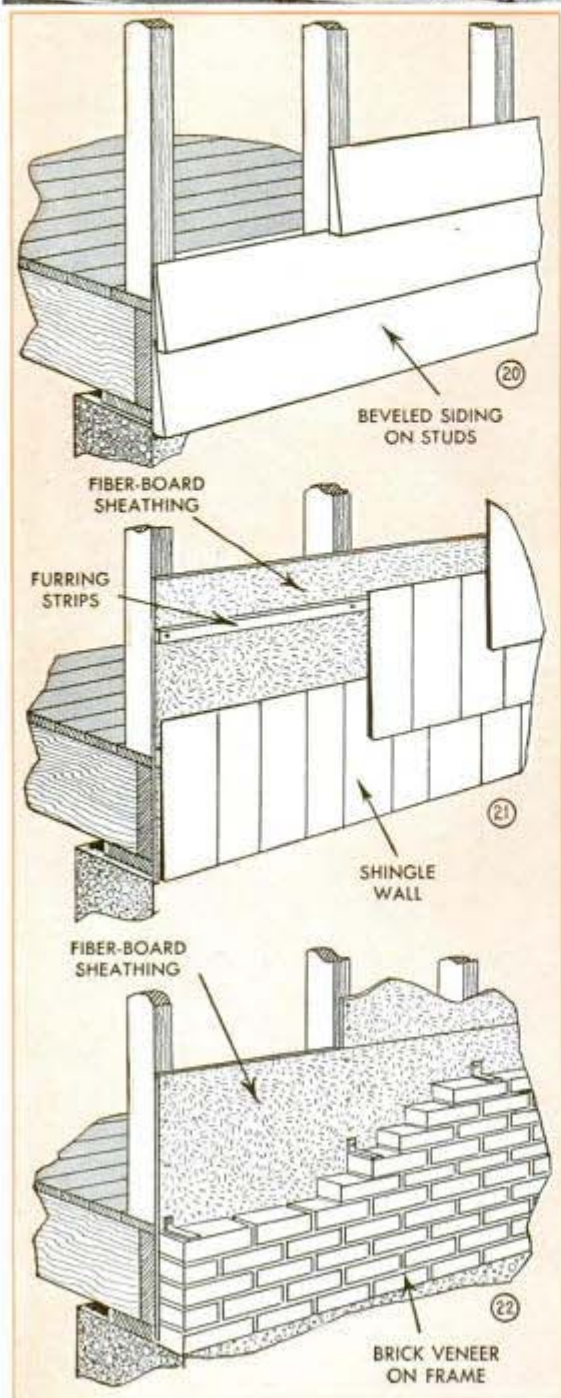
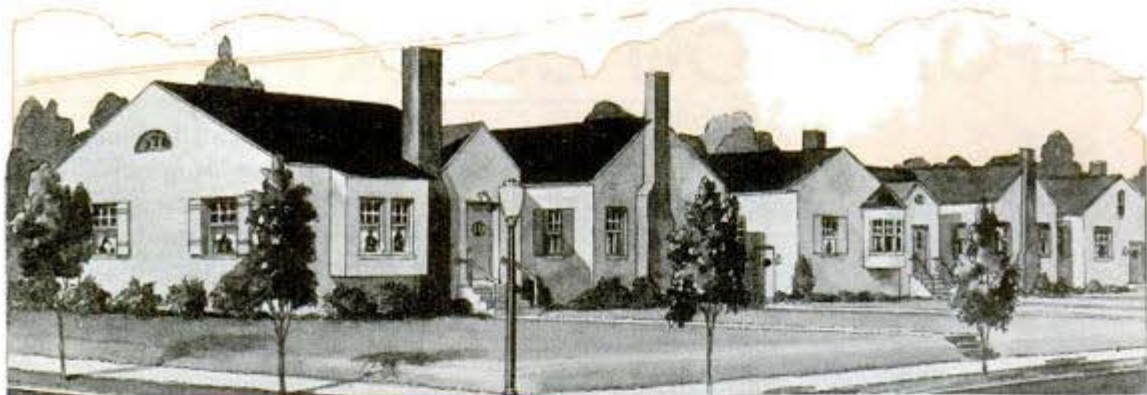

slight rise one can generally assume, other things being usual, that the basement will be dry and that drainage will be adequate. Even if the property is on a steep slope or side hill, drainage is likely to be good unless the land above the house is flat and the latter area is of considerable extent. Then it sometimes happens that there is a springlike seepage either above or on the property. In connection with the lay of the land, always find out about storm sewers and particularly the location of the branch connecting with the basement drain. Once you know the location of the connecting branch, note if there are any large trees near it. Sometimes tree roots give trouble in tile drains, by pushing fine feeding roots into the drain through joints, or by larger roots growing under the tile and heaving and breaking it. If the property is located in a low, flat area which appears to be of considerable extent then the thing to find out is whether or not there is natural drainage to carry away subsurface water. The point to remember is that wherever there is an unduly slow drainage of subsurface water from one point to another or to lower levels, the chances of continuing water and frost damage to basement walls, footings, floors, and walks are increased.

Next comes the exterior of the structure itself. Usually it is rather difficult to tell about the framing. The details in Fig. 19 show what is generally accepted as good. However, unless you can question the builder, you will have to judge the soundness of the framing by the visible exterior and interior details of the building. If the house has stood for some years and still has that general well-set-up appearance, with tight siding, uncracked masonry or brick (depending on the construction), plumb corners and walls, and a true ridge line, then there's little need to bother about the framing. One thing always to watch for in

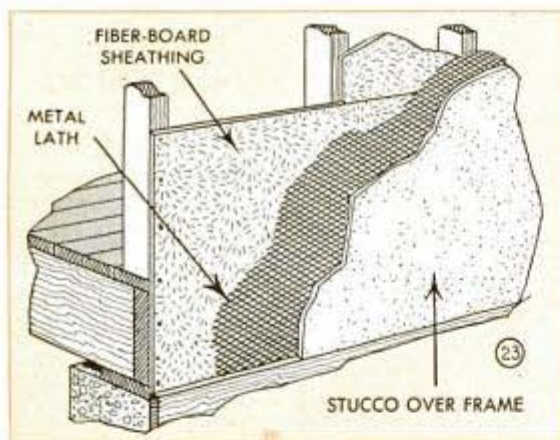

an older house is whether or not the beveled siding is nailed directly to the studding, no sheathing at all, Fig. 20. You can generally tell by rapping smartly on the siding. If a rap produces a thin, hollow sound investigate further. If heavy tongue-and-groove drop siding was used then the defect is more easily remedied. But where beveled siding is nailed directly to the studding there is no satisfactory way of furring the walls for stucco or shingles. It can be done, of course, but is not always permanent. Figs. 21, 22 and 23 show generally approved wall construction for shingles, brick veneer and stucco, using a fiber-board insulating sheathing. However, it is only in houses built in the last few years that one will find this particular wall construction. Prior to this a shiplap sheathing was generally used. All types are good provided the work was properly done by reputable builders. In new homes without basements the walls should be examined carefully for defects. If they are available, the builder's specifications should be checked. A careful builder will have followed them in every detail.

It is always a good idea to check the four corners of a house with the spirit level, as in Fig. 24. Be sure to note whether there are any evidences of faulty flashing around the chimney, dormers and in roof valleys, Fig. 25. It may be necessary to go into the attic and make a detailed inspection for evidences of leaks. Usually the remedy is

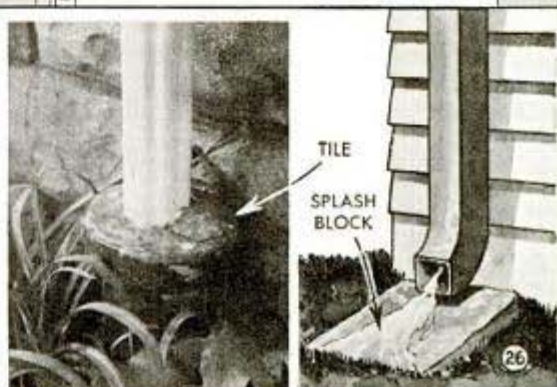
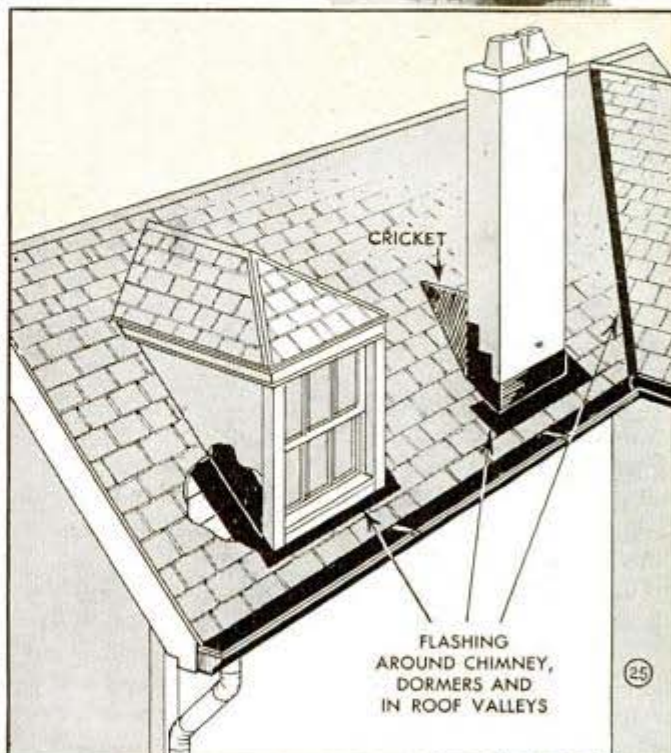

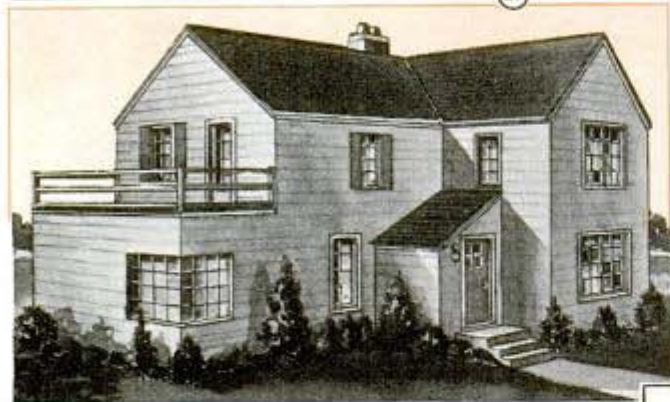

new construction and of a more nearly uniform size but quite frequently you will see a large house, old in years, and flanked on either side with smaller, newer homes. Of course, such a dwelling looks out of place. Adjacent homes emphasize its date of construction and its probably rather gaunt architecture, while it in turn detracts from the newer developed properties. However, many types of older houses, particularly the L-shaped structures, lend themselves well to inexpensive modernizing. Fig. 27 is an example that offers just one suggestion of what a bit of planning will do to the stiff outlines and drab appearance of an old structure. Picture windows, flush cornices, removal of porches, wide siding to "lower" height, and an addition to break up the ridge lines are a few in-

simple and inexpensive but on certain roof designs it may be rather difficult. The upper side of a wide multiple-flue chimney projecting through the roof at any point below the ridge should be protected by what is known as a "cricket." This is a triangular-shaped affair of sheet metal which is flashed to the roof and chimney and prevents any accumulation of water and snow on the upper side. Another thing to look at closely is the provision for the disposal of water from the gutters. This is important because the drainage problem is involved and it will take time and money to remedy any defect. Fig. 20 shows two common methods, either of which is effective. Leading the downspouts into a tile that connects either with a cistern or the storm sewer is in some respects the best, although a splash block is suitable if it is large enough to conduct the water some distance from the basement wall. In connection with the cistern, remember to ask about the construction. It is generally conceded that in a reasonably well-drained location the best construction for a cistern requires that it have a concrete bottom or "floor," but the sides should be of brick laid up loose, that is, no mortar in the joints. Some older cisterns have a fine gravel or sand bottom. In any case the cistern should be provided with an overflow and manhole for cleaning.

The drawing above Fig. 20 brings up another point to consider. Here all the homes are of fairly

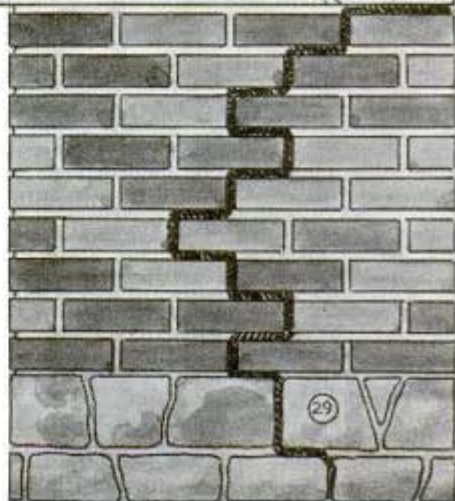
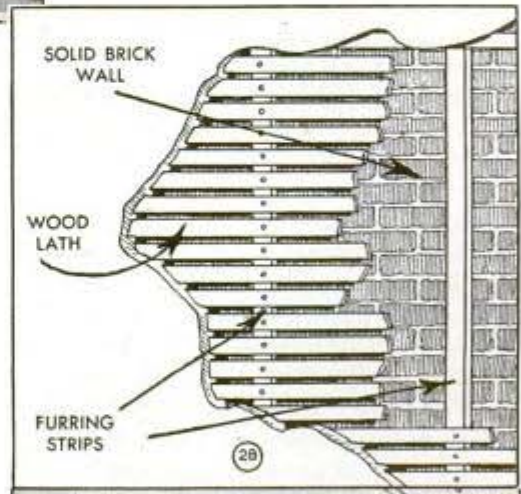

expensive alterations that change a rigidity of line to a harmony of easy and pleasing contrasts. This done, an old house will no longer look and be out of place. When you're inspecting the exterior of an older dwelling keep in mind what these simple changes can do in the way of adding to livability and resale value.

Figs. 28, 29 and 30 bring up still other points in connection with the examination of both the very old and the "middle-aged" homes. If you learn that the walls of any house are solid brick or masonry construction be sure to find out definitely whether the plaster is "furred" away from the wall as in Fig. 28. You will sometimes find plaster applied directly to a brick or masonry wall. Under certain conditions of dampness and temperature changes these walls will "sweat," that is, moisture will condense on the surface and cause trouble, in addition to creating unhealthy living quarters. If you discover a crack in a masonry wall like that in Fig. 29, it generally means that a condition of strain has been developed by undue and unequal settling. Unless the crack runs the height of the wall, involves a corner or the adjacent sections show evidence of movement, it is generally safe to assume that the crack can be pointed up and will give no further trouble.

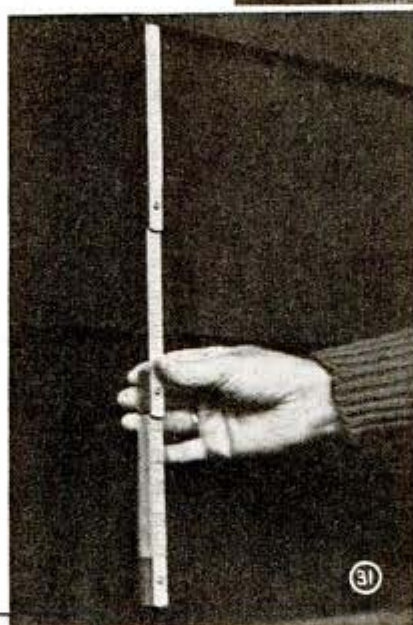

Another defect to look for, especially in brick veneered walls, is an open-horizontal crack. If it runs for only a short distance the chances are it is not important, but if it is long and well open it may mean that the wall is tipping or bulging outward. Such instances are comparatively rare and are likely to be due to

causes other than poor workmanship. "Blisters" on stucco walls, due generally to moisture getting behind the stucco coating, are more or less minor defects as it is usually easy to remedy the conditions causing the trouble. Chip the mortar in brick or masonry joints with a penknife or other sharp-pointed tool, Fig. 30. If it's hard it's probably in good condition throughout the whole structure, but if it's soft and powdery better look the walls over carefully for other evidences of crumbling mortar.

On shingled walls there is little likelihood of defect except where the staining has been neglected and where the shingles have been laid with a greater exposure to

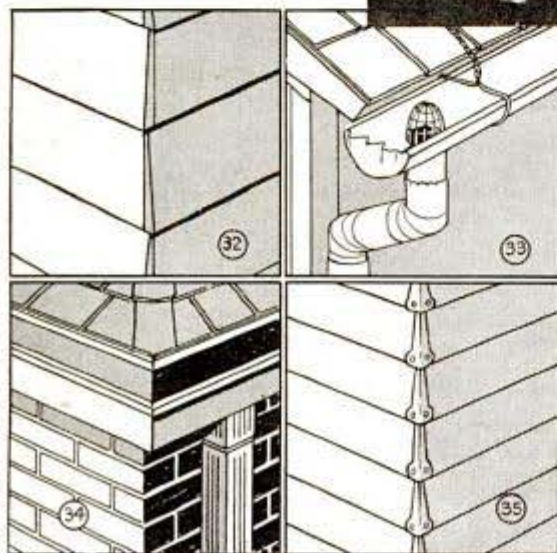

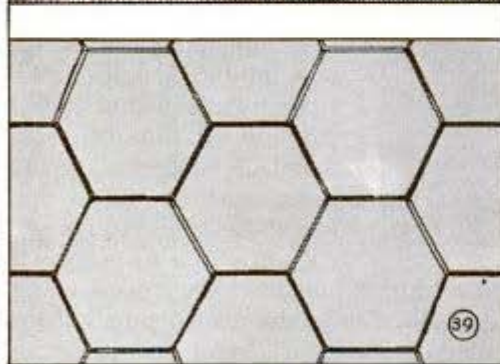
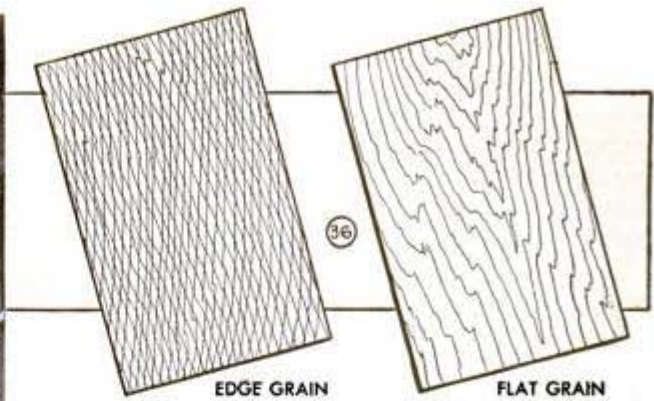

HEXAGON STRIP SHINGLES

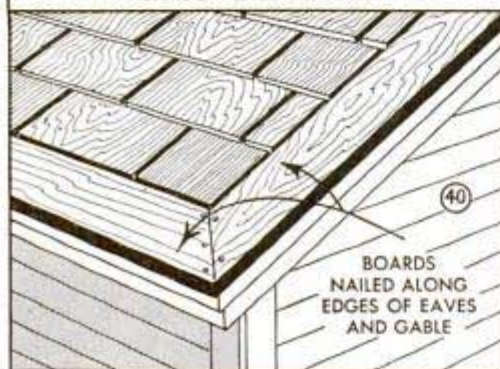

BOARDS
NAILED ALONG
EDGES OF EAVES
AND GABLE

the weather than recommended, Fig. 31. When shingle walls are double-coursed and butt-nailed the exposure is often as much as 12 in. for a 16-in. shingle, and 16 in. for a 24-in. shingle. Note whether the shingles at the corner are "laced," that is, overlapping, or whether they are mitered, the latter being generally considered the best construction. Note also whether shingles are of the flat or edge grain type, Fig. 36, the latter being considered the best. Beveled siding is sometimes cornered as in Fig. 32, but a better job is mitering and finishing with a metal corner strip, Fig. 35.

Although gutters are a comparatively minor item they should, of course, be included in the inspection. Usually they are either of the hanging or box type, Figs. 33 and 34, the latter being perhaps the best because it can be anchored solidly to the cornice. However, it is more difficult to remove when renewal is necessary. The type of cornice tends to "date" a house. The overhanging, open type, Fig. 37, is desirable from the standpoint of weather protection, but it is difficult to paint, necessarily weaker and tends to darken the interior of the house. The narrow box cornice is generally more to be desired because it is better in structural detail and appearance.

Next comes the roof. Wooden shingles should be laid with the edges abutting, not separated as in Fig. 38. Also, abutting edges should be located as much as possible over the center of shingles in the next row underneath. There are several types of composition strip shingles, the hexagon type, Fig. 39, being a common one.

If the house has been re-roofed, composition shingles over wood shingles, or wood over wood, find out whether edging boards, Fig. 40, have been fitted at the gables and in the valleys along the eaves. Frequently this essential detail is omitted in re-roofing. Composition shingles laid without edging boards are apt to be stripped off at the gables and eaves by a high wind, necessitating a troublesome repair.

Revolving Sprinkler Cutouts Give Novel Effect

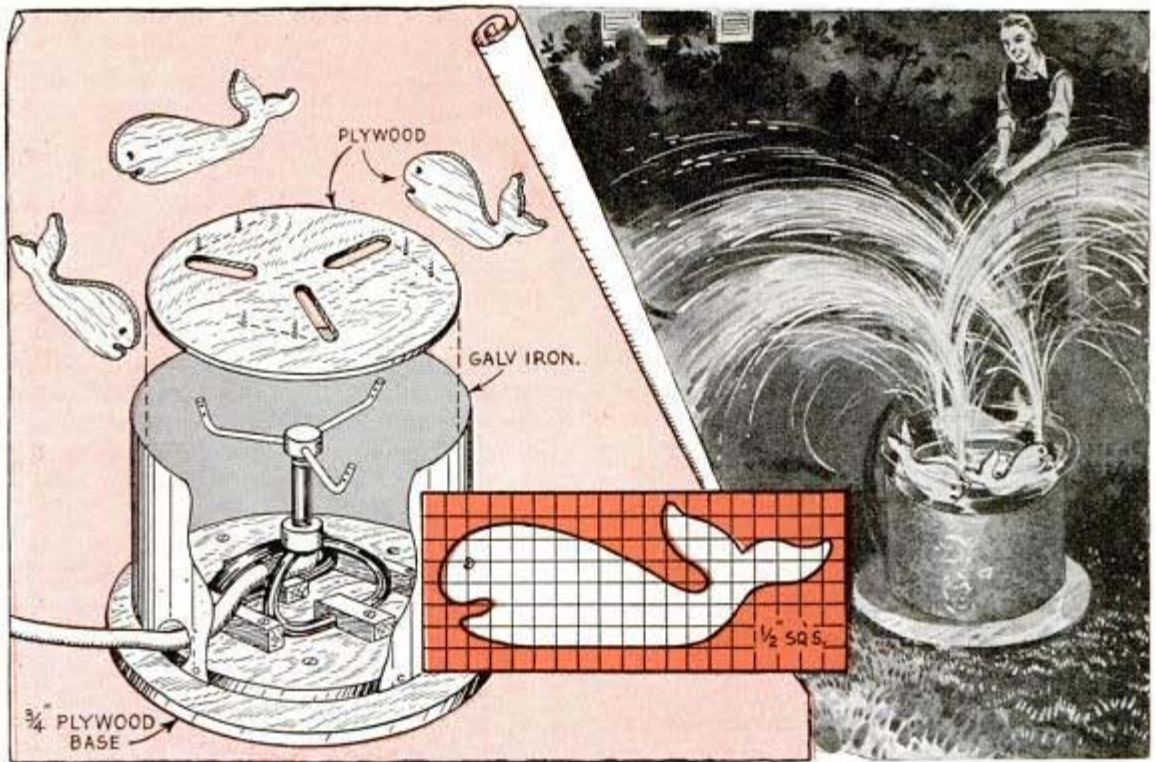

Miniature cutouts of whales that give the appearance of swimming and "blowing" in a lifelike manner make this sprinkler a novel addition to other lawn and garden ornaments. Almost any $\frac{1}{4}$ -in. wood or hard-pressed board can be used for the cutouts and top, and the base disks can be cut from $\frac{3}{4}$ -in. stock. After assembling the two-part base, the sprinkler head is cen-

tered on it and fastened securely with four cleats. A piece of galvanized iron or a large tin can, with the top and bottom removed, provides a shield to hide the head and a screw eye driven into the edge of the base makes a convenient method of hanging the unit on a wall when not in use. Also, the can or metal shield serves as a handy reel on which to wind the hose.

Cover for Overflow Speeds Opening of Clogged Lavatory

When opening a clogged lavatory or bath-tub drain with a plumber's force cup, the job can be done quickly if an airtight cover is clamped on the overflow. This makes it possible for all of the air pressure to be forced down the drain pipe instead of allowing some of it to escape. The cover consists of several pieces of rubber, cut from an old inner tube, two pieces of tin and a couple of stove bolts with washers and wing nuts to fit. Bolt heads are cut off and the ends bent to form L-hooks after which the overflow opening is measured and holes made in the rubber and tin pieces to take the bolts.

—E. G. Machauer, Memphis, Tenn.

☐ When lemons become dry they can be softened by immersing them in cold water.



Simple ENLARGER

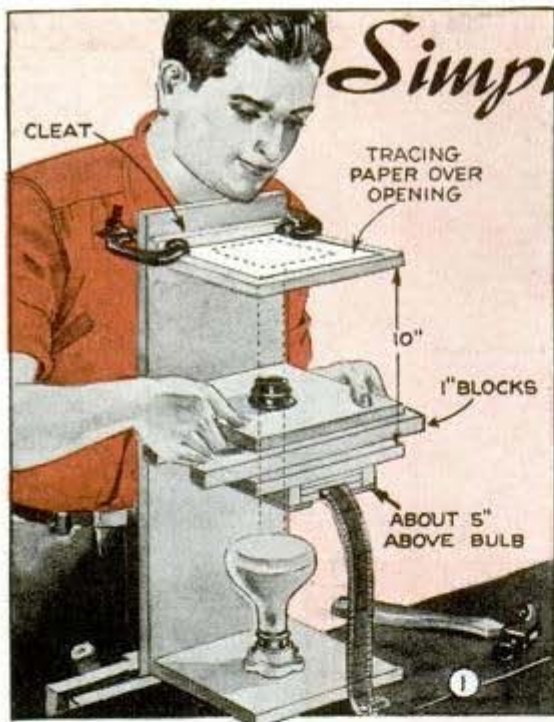

For illumination you use a 100-watt floodlamp of the diffusing-type in which a silvered reflector is integral. About 3 in. above the top of the lamp a 5 by 7-in. opal glass is mounted so that it slides between two cleats. The center-support piece is located about 2 in. above this, and it has a hole in the center a little larger than the hole in the film carrier, which slides between two guides screwed and glued to the underside of the center-support piece. Above it is the lens board, which is adjustable for focus, and is connected to the

JUST like printing in an ordinary contact printer, it's an easy matter to make one-size enlargements with this small enlarger. Essentially it consists of a box having $\frac{1}{4}$ -in. plywood sides screwed to end pieces and a center-support piece of $\frac{1}{2}$ -in. stock. The lower half of the front is removable while the top half is left open to permit insertion or removal of your camera lens, which you use for the enlarger.

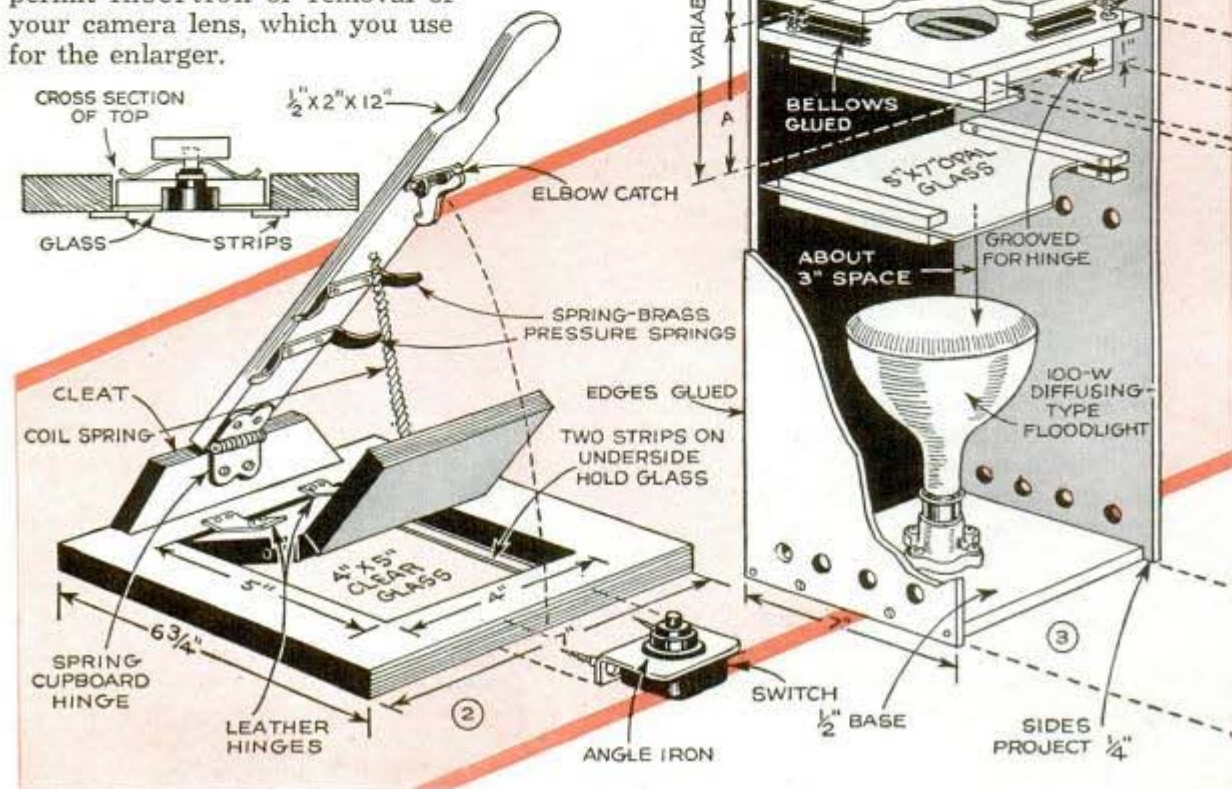

for 35-mm. FILM

center support piece by means of a simple bellows that allows movement, yet excludes light from the upper portion of the enlarger. The bellows can be made from imitation leather and is cut as shown in Fig. 5.

As the enlarger is made to suit your particular camera lens, and is designed for enlarging to a predetermined size, there are two variable dimensions, A and B, Fig. 3, that must be ascertained. These dimensions should be determined as accurately as possible. To do this you fasten the lamp to the base, already cut to size. Fasten a board to extend vertically from one edge and then screw or nail

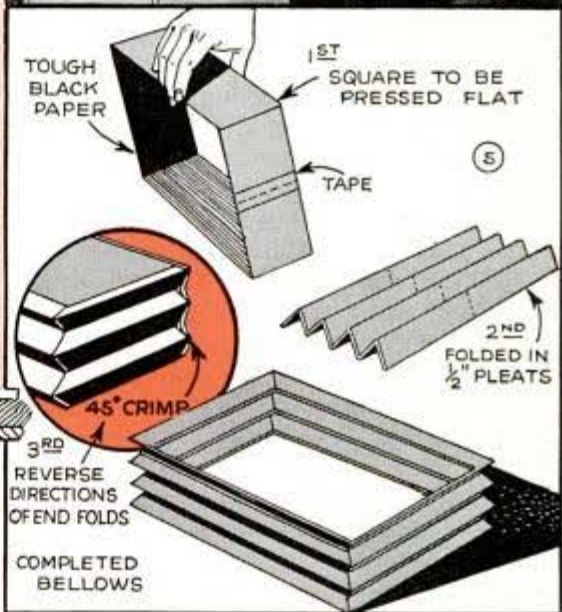
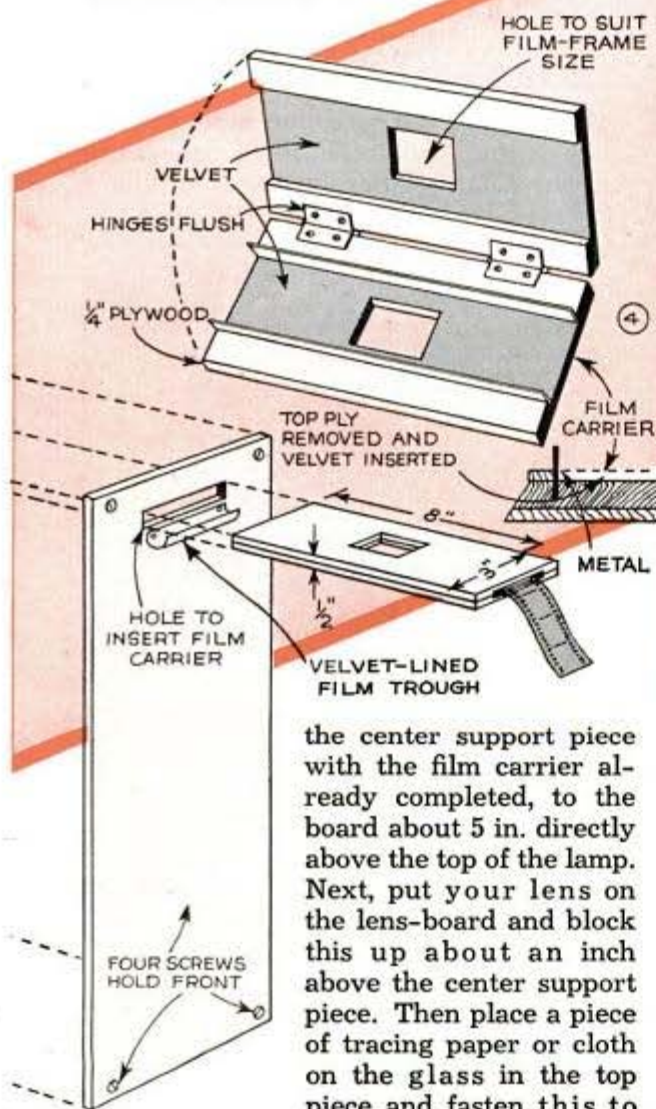

the center support piece with the film carrier already completed, to the board about 5 in. directly above the top of the lamp. Next, put your lens on the lens-board and block this up about an inch above the center support piece. Then place a piece of tracing paper or cloth on the glass in the top piece and fasten this to

the board about 10 or 12 in. above the center support piece, Fig. 1. Now, by adjusting the lens-board, you can get the picture (negative being in film carrier) in focus. If picture is too large lower the top and again adjust lens-board to sharp focus until the size of the picture on the tracing cloth is brought to the dimensions you desire. After size and focus have been achieved, carefully measure distances A and B, which will determine the height of the enlarger and the proper spacing between the top, the lens-board and the film

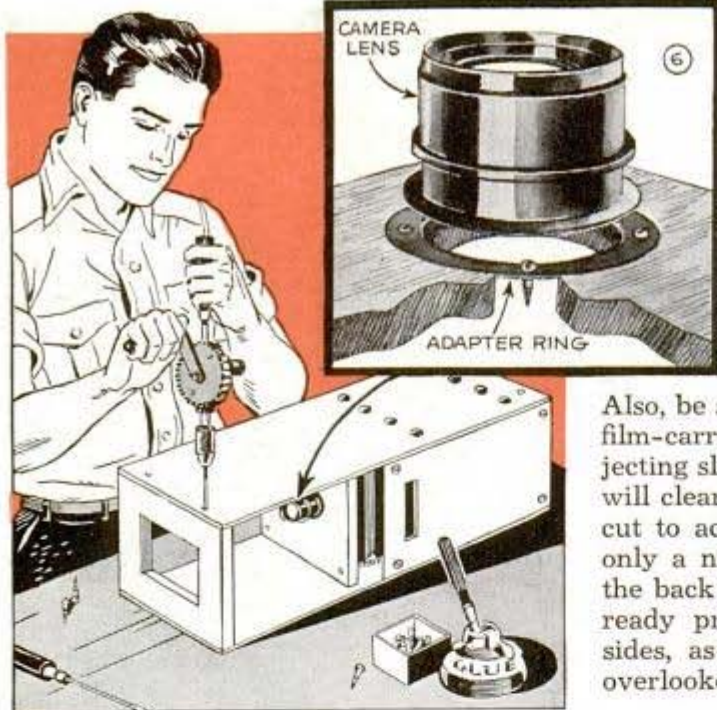

carrier. When the three sides are screwed to the top and bottom, and the cleats to hold the opal glass are in place, again check for exact position of the lens-board before permanently screwing the center support piece in place. The manner in which you attach your lens to the lens-board depends upon the type of lens at hand. Fig. 6 shows how a standard adapter ring can be used to hold a barrel-type lens. Critical adjustment in focusing as well as getting the lens at right angles to the negative is done by four screws that can be tapped into the center support piece which should be hardwood. Coil springs of suitable pressure are slipped over the screws and fit between the lens-board and center support piece. If you desire, each corner of the center support piece can be slotted deep enough to take nuts to line up with the holes, in which the screws are driven—in this case machine screws.

Details in building the top and the film carrier are shown in Figs. 2 and 4. A spring hinge on the handle will keep it in the raised position when placing paper on the glass, and in this position the pressure blocks will also be held out of the way. When the handle is brought down, the pressure blocks contact the paper to keep it in position before the switch is pushed in. An elbow catch is fitted to the underside of the handle to engage the angle bracket on which the switch is mounted.

When making the film carrier be sure that the two hinges are flush with the inside surface of the plywood of which it is made. To make a scratchless film track, remove a strip of the outer ply on each piece as shown, as wide as the film, and then glue in strips of velvet. To retain the film on this cloth track, fit a metal strip along each side of the recess, (see Fig. 4), in the lower piece.

Also, be sure to cut a groove in one of the film-carrier guides so that the hinges projecting slightly from the side of the carrier will clear. The removable front has a slot cut to accommodate the film carrier, but only a narrow velvet-lined slot is cut in the back to permit passage of the film already printed. Ventilation holes in the sides, as shown in Fig. 3 should not be overlooked.

Picture Hooks Hold Background

How to hang a large drape against a wall to serve as a photographic background is a problem that can be solved with ordinary

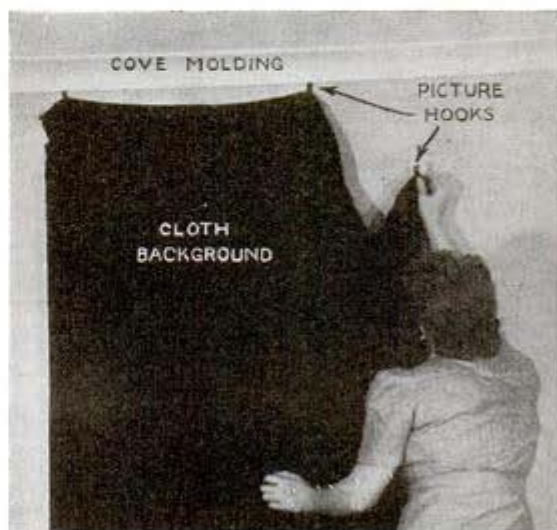

molding-type picture hooks. Attach three or four hooks to the end of the drape and use them to suspend it from the molding. The drape will lie flat and can be removed easily when no longer needed.

—Louis Hochman, Brooklyn, N. Y.

☞ "Oyster-ring" effects on ferrotyped prints can be avoided if you first squeegee them under a blotter to remove excess water before they are rolled onto the tins.

Versatile FLASH-FLOOD LAMP UNITS

BUILT from common electrical parts at a nominal cost, the lamps of this lighting outfit can be used separately or in various combinations. Also, the unit can be packed into a flat carrying case no thicker than the diameter of a photoflood bulb. Parts needed to make it are sockets, shade holders, a 3-way plug, an extension cord, a flash gun and reflectors that can be flattened when unhooked at the seam. To use the outfit as a 2-lamp flash unit, screw the plug into the flash gun and insert the lamp leads as in Fig. 1. If desired, an extra lamp for overhead lighting can be connected into the third outlet of the plug. When using photoflood lamps, unscrew the 3-way plug from the flash gun and connect it to an extension cord, Fig. 2. A simple bracket, consisting of a short length of tubing fitted with a bolt and wing nut, permits the unit to be supported on a folding lamp or music stand, Fig. 3. To use the flash gun with a single reflector merely unscrew the parts required from the unit. Fig. 4 shows how the outfit can be used for an overhead bank of lights by suspending it from a support with cords or wire tied through holes in the ends.

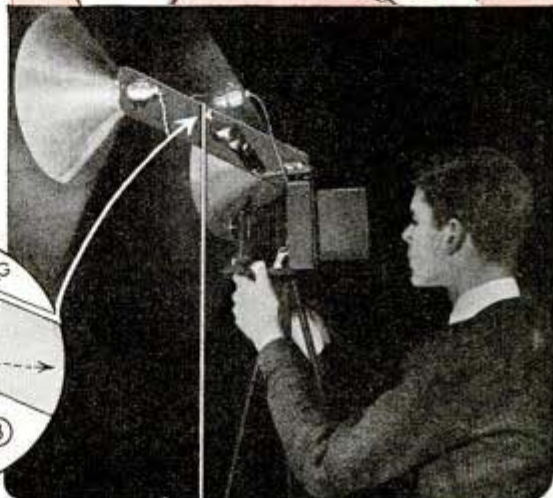
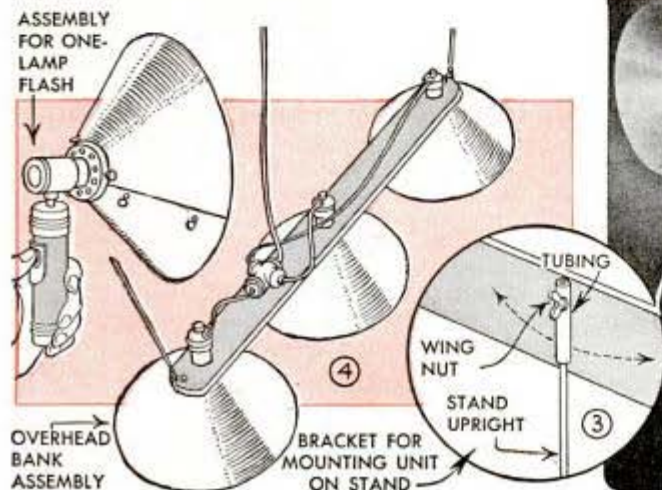
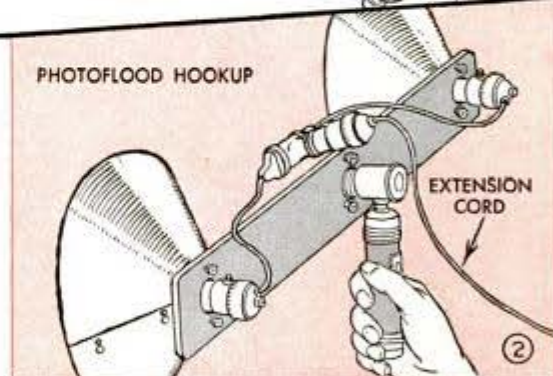
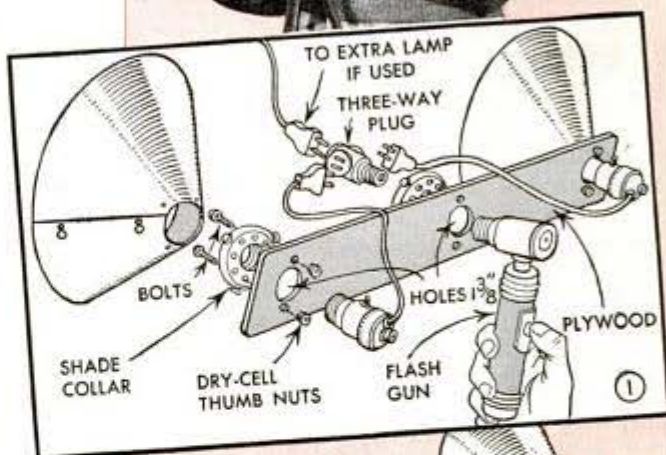

Enlarging Meter Read Easily Through Flashlight Lens



Enlarging meters of the grease-spot type can be made easier to read if a bull's-eye flashlight lens is laid over the indicating window. This increases visibility from any

angle. The lens can be lifted between the fingers and used as a magnifier on certain jobs such as enlarging dense negatives.

Skimmer for Photo Solutions

This skimmer removes dust, fibers, etc., that collect on top of a photo solution left standing in a tray. To make it, bend a wire coat hanger into a rectangle and wrap cheesecloth around it.



This Sturdy Lawn Chair Is Designed for Comfort



Lawn Chair—1058: This chair can be built with a few hand tools. Plan calls for stock sizes of lumber. Curved, slatted seat assures comfort. Complete construction details and list of material will be sent postpaid for only 25c.

OTHER GOOD SPRING PROJECTS

DUTCH WINDMILL—1059: Stands about 5 ft. high. Simplified design. 25c.

FLOWER BOXES—1061: Three attractive patterns, designed for durability. 25c.

LAWN CHAIR ON WHEELS—978: Light in weight and easy to wheel to any desired location. Cushion extends over both seat and back. 25c.

ORNAMENTAL WOOD FENCES—640: Five artistic designs for standard wood stock. 25c.

CIRCULAR ARBOR AND GATE—637: Popular style anyone can build. 25c.

LAWN AND GARDEN FURNITURE—920 to 922 incl.: Collection of designs for arbor-and-seat combination and swings. 3 prints 75c.

TRELLIS SUGGESTIONS—639: Six types that will help beautify your home. 25c.

BARROW CHAIRS—924: Two styles. Built for comfort. Simple construction. 25c.

12-FT. UTILITY ROWBOAT—707: Flat bottom, four seats. Very sturdy design. Fine for boat livery rental purposes on small lakes. 25c.

JIGSAWED LAWN ORNAMENTS—1051: Ten colorful figures. Color scheme of each given. You can increase your income by selling such ornaments at roadside stands. 25c.

LOG-CABIN CONSTRUCTION—916: Two floor plans. Shows how to make corner joints. 25c.

OUTDOOR FIREPLACES—917: Several simple, but practical types, to match other items in rock garden. 25c.

Order plans by number and title. Send postcard for FREE 128-page catalogue of popular mechanical books and handicraft plans

Dept. 382 — Popular Mechanics Press, 200 East Ontario Street, Chicago, Illinois

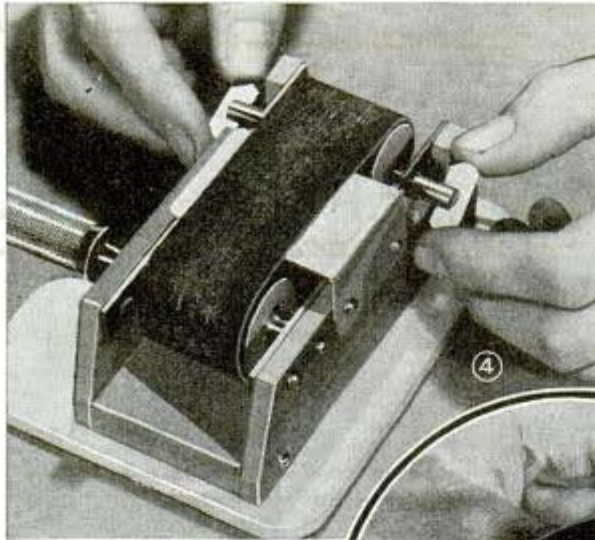

and withdrawing the latter. L-shaped slots in the side strips permit lifting out the idler drum. Fig. 3 shows how the latter is pushed, and then centered on the shaft with a nut at each end, after which one of the nuts is backed off just enough to allow the drum to spin freely. Finally the little belt table is attached with two machine screws turned into tapped holes. The sanding belt will travel smoothly over the drums if the ends are butted at an angle. A cloth tab

coated with flexible cement is used to join the strip, as in Fig. 5.

Trackage of the belt is checked by turning the drums by hand first. If the belt works to either side, the wing nuts are loosened and the idler drum is re-adjusted as in Fig. 4.

is best to turn the wood drums slightly oversize so that they can be trued later and properly crowned when mounted on their shafts. Short rubber bands cemented edge to edge across the crown of the drums can be used as nonslip tires for the belt. When soldering the drive-drum bearings, keep them at exact right angles in the brass side strips, otherwise the shaft is apt to bind. To drill corresponding bearing and screw-mounting holes in alignment in the wood and metal side pieces, clamp both together and cut at one time. As shown in Fig. 6, the drive drum is removed to make belt changes by loosening the setscrew in the collar which holds it to the shaft,

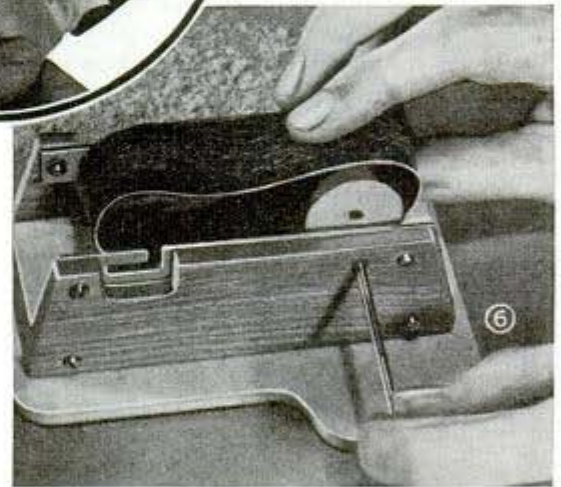

Duplicate Collars Cut Quickly With Double-Feed Setup

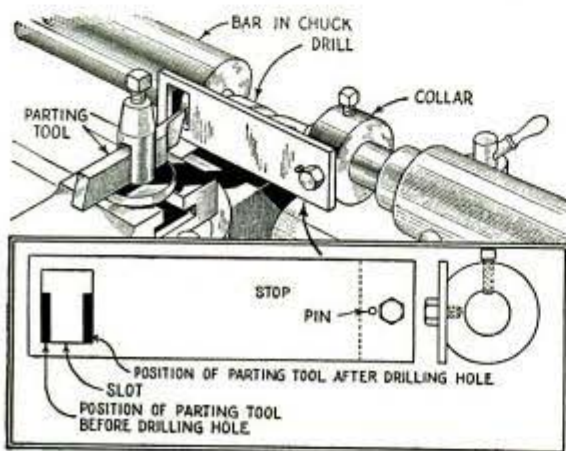

Producing duplicate collars from a steel bar is a simple matter with this lathe setup. First, turn a collar to fit the tailstock spindle and machine a flat on it for attachment of a parting-tool stop. This is made from a piece of steel and has a square opening in the free end to take the parting tool. In use, the drill is advanced against the work after which the parting tool is set so that it just clears the left side of the stop opening. This determines the width of the collar and both tools can then be advanced at the same time as the drill will be stopped automatically when the parting tool touches the right side of the square stop opening.

Lumber Loaded by Backing Truck Under It

By using these trestles, a lumber company of St. Louis, Mo., is able to load a truck with five to six thousand feet of lumber in 5 min. This permits them to handle their increased business, due to defense orders, with their regular truck fleet as no truck has to stand idle for some time while it is being loaded a piece at a time. The load is merely piled on the trestles by workmen while a truck is making a delivery, then on its return, the driver backs under the new load and is on his way again.

As you will notice, the front trestle is a vertical one that is pushed over easily as the truck backs under the load, which then drops onto the first roller of the truck body, enabling the driver to back under the en-

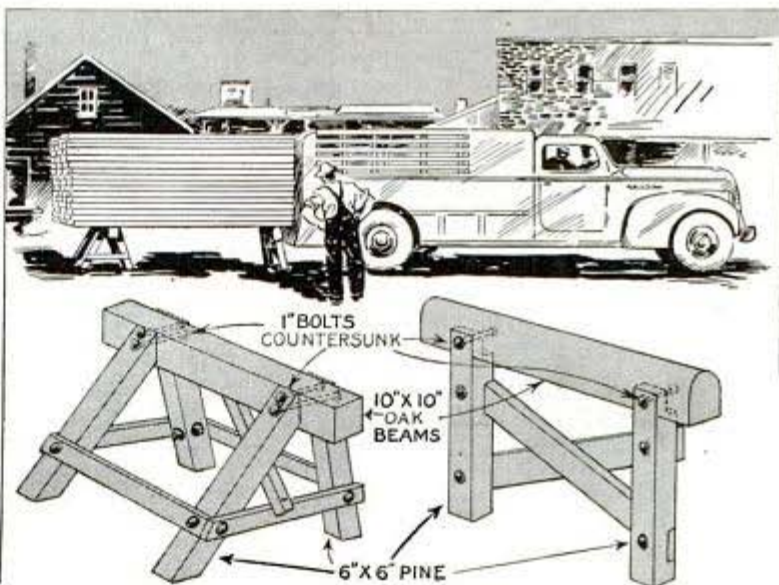

tire load. When the truck reaches the rear trestle, which is braced at an angle of 45 degrees to keep it from tipping, the load is moved the remaining few feet onto the truck with the body-roller hand cranks.

Cloth Mat on Scale Platform Recovers Spilled Grass Seed

One seed dealer, who filled many orders for small quantities of grass seed, found that frequently some of the seed was lost by being spilled on the platform of the scales as a bag was being filled. To avoid this loss, he made a cloth mat to lay on the platform. The cloth, slightly smaller than the scale platform, had a length of dowel

tacked along opposite edges to facilitate handling it. When seed was spilled during the weighing, it was recovered easily by lifting the cloth and doubling it to pour the contents into the sack.

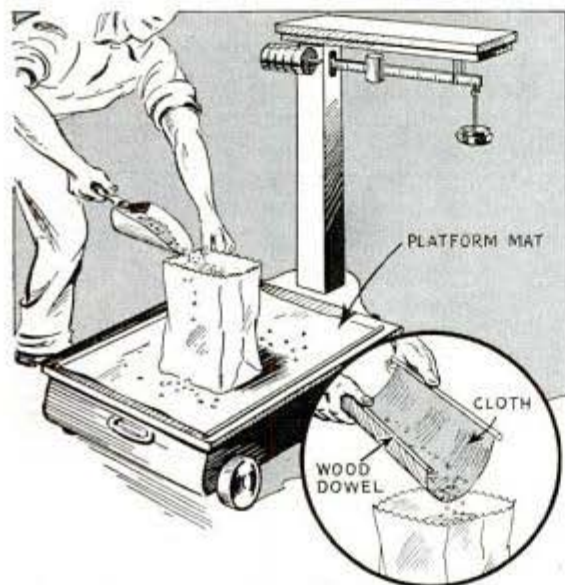

Economical Holder for Rock Salt

To hold blocks of rock salt with the greatest economy and cleanliness when provided for animals in pastures, one farmer drives a length of pipe into the ground and drops a pair of discarded harrow disks over it as shown. As most blocks of rock salt already have a hole drilled through the center when they are purchased, this arrangement prevents their dislodgement by the animals and keeps them from being soiled on the ground.

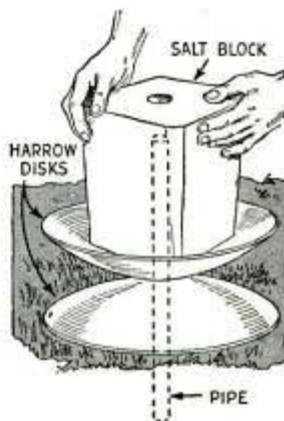

Ash Tray Holds Paper Clips On End of File Drawer



If you work in an office and do a lot of filing, an auto ash tray fitted with a vacuum cup will be just the thing to use for a paper-clip holder. The vacuum cup provides a quick means of attaching the tray to a drawer front and the clips will be at hand when needed.

Angle-Iron Guide on Metal Shears Helps Square Large Sheets

When obtaining large sheets of sheet metal from the manufacturer, we find that the ends are sometimes uneven, and with the small square on our shears, it is almost impossible to square the ends accurately. To overcome this difficulty, we removed the gauge bar and bolted a heavy piece of

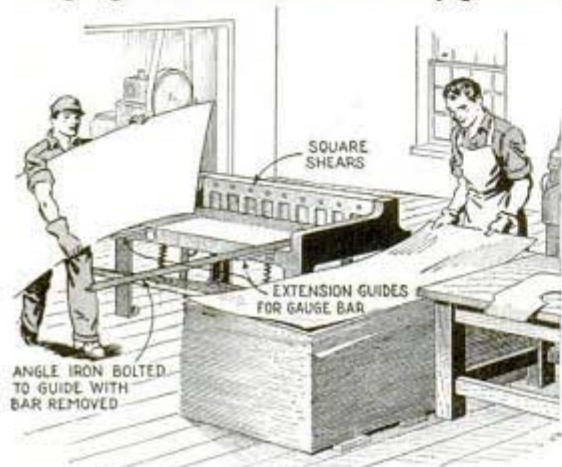

angle iron on one of the extension guides at right angles to the knife. With this arrangement, it's a simple matter to use the angle-iron guide and square the ends of several sheets in a short time.

—Homer Sweany, Beech Grove, Ind.

Feed-Cooking Kettle Supported By Old Auto-Wheel Rims

Needing plenty of draft for a fire under a feed-cooking kettle, one farmer supported it at the desired height with auto-wheel rims. Three rims were set in the ground at an angle so that the kettle could not slip off them.



Level Fitted With Feet to Use It Accurately on Rough Surfaces

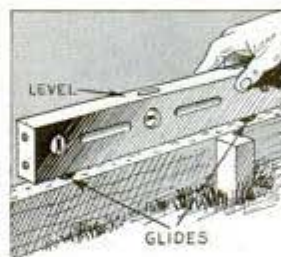

For leveling concrete forms and other work where the surfaces on which the level must rest are likely to be rough, one contractor fitted the level

with a couple of furniture glides, which served as feet. With this arrangement it was only necessary to clean a place on the work on which to rest the feet.

Rubber Ball Used as Container To Carry Tacks in Pocket

One window decorator who uses tacks in assembling crepe-paper decorations carries the tacks in a hollow rubber ball. A short slit in the ball is opened by squeezing to remove the tacks as desired, after which it closes automatically. The container can be carried in the pocket with safety.



KEEP YOUR CAR LOOKING NEW

CLEANING and waxing your car must be done correctly if the results are to be satisfactory. If the surface is coated with road grime or dried mud, wash it thoroughly, Fig. 3. Don't use a stream of water under high pressure. This will drive the dirt and fine grit right into the finish. Use a sprinkler head on the hose and open the valve less than halfway, directing the spray against the body at an angle. If you don't have a hose, an ordinary sprinkling can will do. It's better and quicker than a cloth or sponge, and there's no danger of scratching the finish.

Immediately after washing and before the water dries on the surface, take up the surplus water with a chamois, Fig. 4. Then let the surfaces dry and you're ready for the wax. Use either the liquid or paste form. If you have time to polish your car frequently, liquid wax is your best bet as it takes less time to apply. However, it may not last as long as the paste. If you clean up the car occasionally, the paste wax is best as it leaves a thick coating that will protect the finish longer than the liquid wax. Both the applicator cloth and the polishing cloth should be of a coarse mesh, such as cheesecloth, or open-mesh polishing material which is woven especially for the purpose. You can obtain this cloth inexpensively at service stations and auto accessory stores. Never use an or-



FOLD CLOTH INTO SQUARE PAD

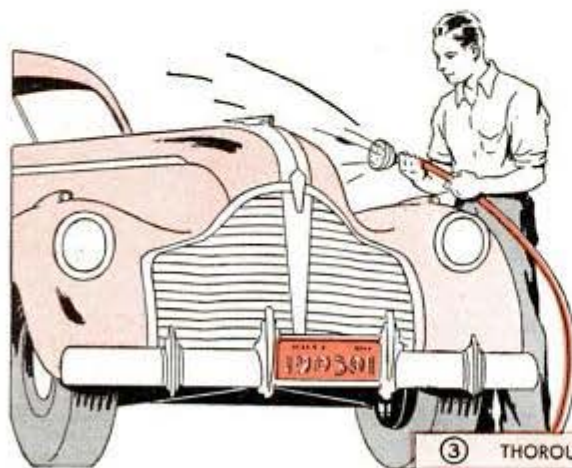

③ THOROUGH WASHING IS IMPORTANT



Dry with a chamois

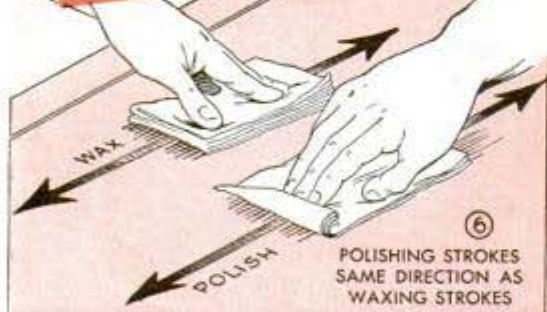
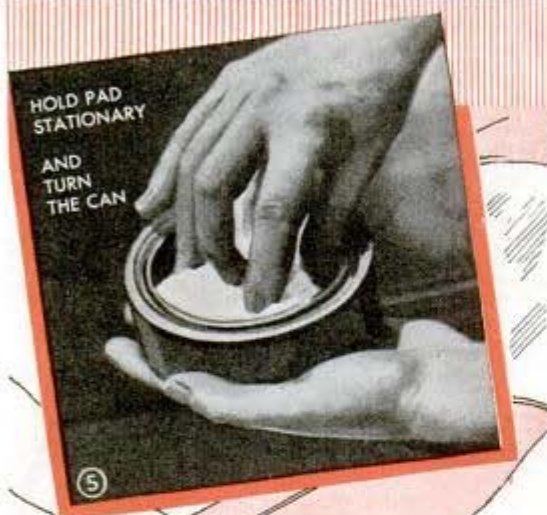

BE SURE THE CHROMIUM IS DRY

dinary cloth of tight weave for the surface will quickly glaze over, making it impossible to apply the wax or polish it to a high luster. The applicator cloth should be folded into a pad of five or six thicknesses and about 4 in. square, Fig. 2. Take care that no abrasive particles get on the cloth and scratch the finish.

Apply the liquid wax according to the manufacturer's directions. A cloudy, humid day is best for waxing a car as the wax does not dry too rapidly. If you must do it on a clear, dry day, work in the shade. While polishing, shake out the cloth pad frequently to remove the powdery accumulation, refolding to the same size and thickness. Polish with long, uniform strokes as in Fig. 8. Excessive pressure while rubbing is unnecessary. Both liquid waxes and polishes have the property of removing a certain amount of road film and dust as they are applied. Unless the car is badly spotted with mud it will not be necessary to wash it each time you shine it. Simply wipe off the dust with a soft, dry cloth of the open-mesh kind; tightly woven cloth rubbed over grit is likely to cause scratches. Tightly-woven cloth has more of a tendency to pick up and retain tiny particles of grit, which then act as an abrasive.

Applying the paste waxes is just as simple and easy, if you watch the details carefully. There's no necessity for making a hard, tiresome job of it. You use the same applicator and polishing cloths, but with the paste waxes the applicator pad must be wet with water and then wrung out. In picking up the wax with the pad, hold the latter stationary and turn the can as in Fig. 5. Don't press hard on the pad, just lightly, so that it will pick up only a small quantity at a time. Now apply the wax in light, straight strokes as in Fig. 6, covering only a small panel; never more than 2 or 3 sq. ft. at a time. Then immediately—and this is the trick—follow with a dry cloth to spread the film of wax uniformly, picking up any excess. Have the applicator pad in one hand and the "following cloth" in the other as in Fig. 1. Let the wax stand for a minute or so while you're applying some to another small area. Then

Polish with long strokes

rub down the first with a clean, dry, polishing cloth. You'll find that it takes only a few long, sweeping strokes to give a glass-smooth surface and a high luster. Don't bear down hard on the polisher. Continue the same procedure and watch the timing between operations. That's the important thing in handling paste wax. If it gets a bit too dry before polishing, simply go over the area lightly with the applicator and polish down immediately. Or, if it does not dry fast enough, causing the cloth to stick and drag slightly, wait a little longer before polishing. On curved surfaces such as in Fig. 10, you can save yourself a lot of extra work by rubbing across them at right angles to the curve instead of up and down, or the long way of the curve.

Chromium-plated surfaces are waxed in the same way as the body, Fig. 7. If you've washed the car, be sure the chromium is thoroughly dry, otherwise you'll have trouble in getting a uniform coating. Drops of water will collect on the lower edges and overhanging surfaces, and keep the wax from adhering and spreading uniformly over the plated surfaces.

Wax and polish the dash and interior trim last, Fig. 9. Use a smaller pad and apply the wax sparingly. On older cars that have not been polished for some time, and the finish is dulled and roughened, you'll have more work renewing it. First comes a thorough washing. Follow with a prepared cleaner, which comes in both paste and liquid forms, to remove the loosened pigment and discoloration. Cleaners are usually mild abrasives, so handle them carefully on corners and edges. Apply with a pad of the same cloth you use for the wax, rub lightly, and stop when the finish begins to brighten up to its original color. After you've gone over the car, wash it with a gentle spray from the sprinkler head and dry with a chamois. If there are still some dull spots use some cleaner and again wash away all traces of it. Washing with a sponge and neutral soap after the first cleaner application often helps. Then wash the whole car thoroughly to remove the soap. Although it will still be dull the finish should come back to a fairly uniform color after this treatment. Under



WAX THE INTERIOR LAST



ON CURVED SURFACES RUB ACROSS
NOT UP AND DOWN

these conditions the paste wax is best, although either the liquid wax or the polishes will give good results. Likely it will take two or more applications to build up a uniform luster. Proceed in the same way as you would with a newer car, except that possibly you will have to change applicator cloths more often as they are likely to become charged with loosened pigment and glaze over.

Accurate Gauge for Paper Cutter Made From Steel Tape Measure

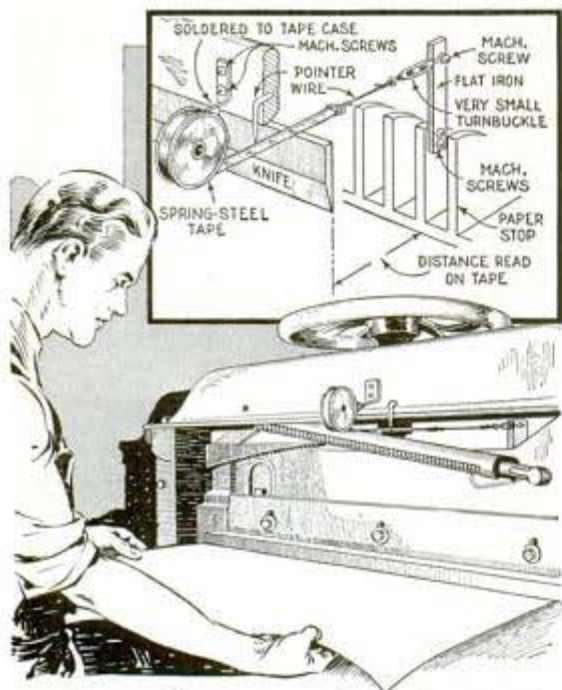

After making a number of mistakes when using my paper cutter, which is not equipped with a gauge, I removed the stop mechanism from an old spring-steel tape measure and mounted the tape on the cutter so that it could be used to set the paper stop accurately. The tape was held horizontally and fastened to the paper stop by means of a length of wire secured to the tape end and a small flat-iron upright screwed to the stop as indicated. To provide fine adjustments, a turnbuckle was installed between the tape end and upright, after which a pointer was fitted on the cutter frame so that the gauge could be adjusted accurately.

—James F. Gardner, Chicago.

Puller to Loosen Gib-Head Keys

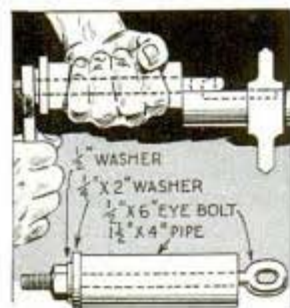

Gib-head machine keys are loosened easily with this simple puller, which is assembled from a couple of washers, an eyebolt and a short length of pipe. In use, it is only necessary to

slip the bolt eye over the key head and place the pipe end against the shaft, as

indicated, so that pressure is applied on the key by tightening the nut. If welding facilities are available, a steel plate may be welded on one end of the pipe in place of the large washer to provide greater strength for loosening the toughest keys without bending or marring the heads.

—Tom E. Dougherty, Torrance, Calif.

Tight-Fitting Pulleys Removed With Two C-Clamps

Next time you have difficulty in removing a tight-fitting gear or pulley from a shaft, try this improvised puller, which is nothing more than a couple of C-clamps and a hardwood

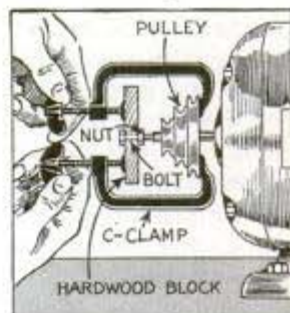

block fitted with a bolt and nut as shown. In use, both clamps are hooked over the gear and the hardwood block centered on the shaft end so that tightening the clamps applies pressure behind the gear.

Surveyor Uses Bottle Caps As Markers on Highways

When surveying roads and streets paved with asphalt or similar material, one group of surveyors uses bottle caps as markers on the pavement. The caps are held in place with long nails, and were found much better than chalk marks, which were easily erased by traffic.



Handy Siphon Wets Sponge to Clean Windshield

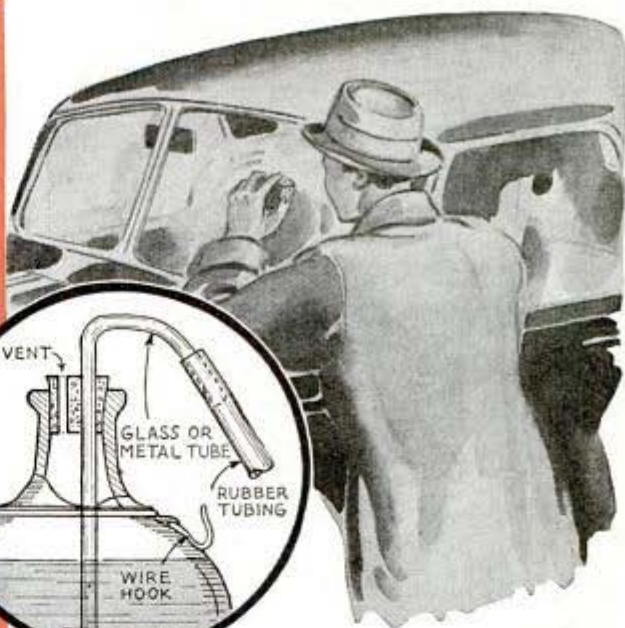
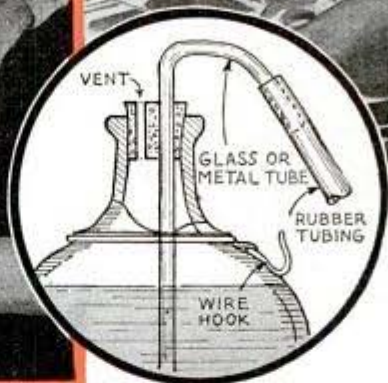

In private garages where a water supply is unavailable, this handy siphon will be just the thing for wetting sponges and cloths to clean the windshield, headlamps and windows. It consists of a 1-gal. jug, a cork, and a glass or metal siphoning tube fitted with a length of rubber tubing. Flow

of water is controlled by pinching the end of the tube, and the stream is stopped by raising the tube above water level. When the siphon is not in use, the end of the rubber tube is hung on a wire hook slipped over the jug neck.

—Walter E. Burton, Akron, Ohio.

Maps on Truck Doors Help Driver Locate New Customers

When fastened on the inside of delivery-truck doors as shown, city and state maps are always at hand for references when serving customers. Drivers can mark regular routes on the maps for convenience and new customers are located easily before closing the doors after a delivery.

Heel Plate on Auto Accelerator Made From Rubber Ball

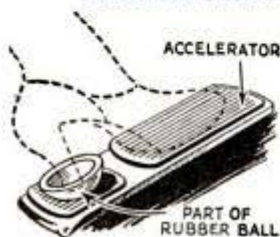

To help a woman driver keep her foot on the accelerator when wearing high heels, one motorist fastened half of a hollow rubber

ball at the lower end of the accelerator as shown. The ball serves as a socket in which the heel is rested. Being flexible, the socket will not mar the heel.



Writing Supplies on Cardboard Carried in Suitcase Lid



The trouble of digging through his suitcase for stamps, envelopes and other letter-writing supplies is eliminated by one salesman who keeps all these items on a large piece of heavy cardboard that fits snugly inside his suitcase lid. Half of the cardboard accommodates a blotting pad while the other half has envelopes of various sizes glued on it to hold stamps, paper clips, etc. Besides keeping these supplies together, the cardboard also serves as a handy lap desk when traveling on a train.

Removable Steel Plate on Anvil Avoids Chisel Marks

If you place a steel plate on an anvil while using a cold chisel, fit the plate with a piece of flat iron bent to the shape shown

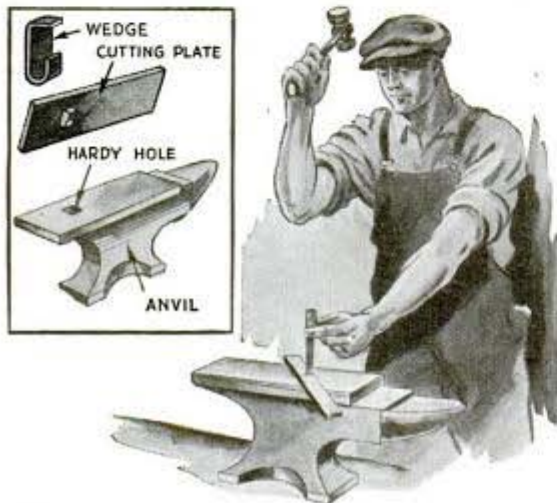

so that it will slip into the hardy hole with a spring action. The flat iron will keep the plate in place, yet allow it to be removed or replaced easily.

Feed Basket Set in Old Tire Not Easily Overturned

To keep an animal from overturning its feed basket or water bucket, place it in the center of an old auto tire. This serves as a good base which will last indefinitely.



Auto Transmission Serves as Jack To Regulate Speed of Elevator

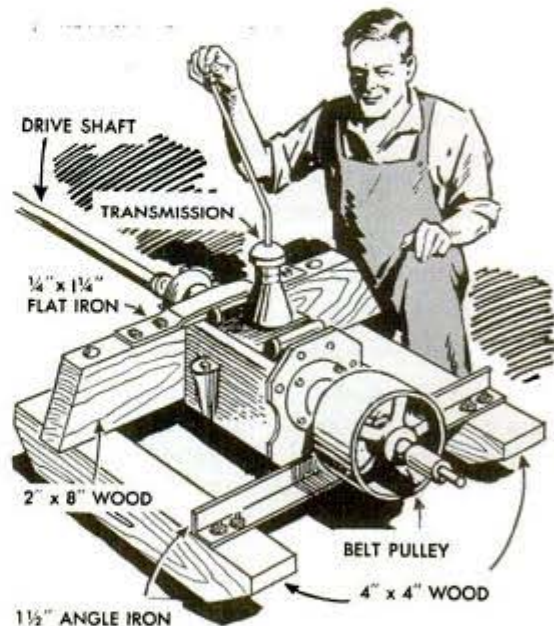

One farmer rigged an efficient speed jack from an old auto transmission to drive his grain elevator at the required speed with an engine. The transmission used was of the type having a torque-tube drive and the enclosed shaft was used as a drive or "tumbling" rod, the outer end being connected to a universal joint on the elevator. A belt pulley was fitted to the splined clutch shaft on the opposite end of the transmission and the whole unit was mounted on an improvised frame of wood and angle iron members assembled as shown in the illustration.

Extension for Truck Body to Haul Long Loads

By fitting this folding extension on the body of a small truck, one lumber company could use it on deliveries consisting of only a few long boards or planks that would be too long for a short body, thus saving a trip for one of their large trucks. The extension is made of large pipe and fittings, and is pivoted through holes in the sides of the truck. When not in use, the extension can be folded forward toward the cab where it lies flat on the bottom of the body out of the way.

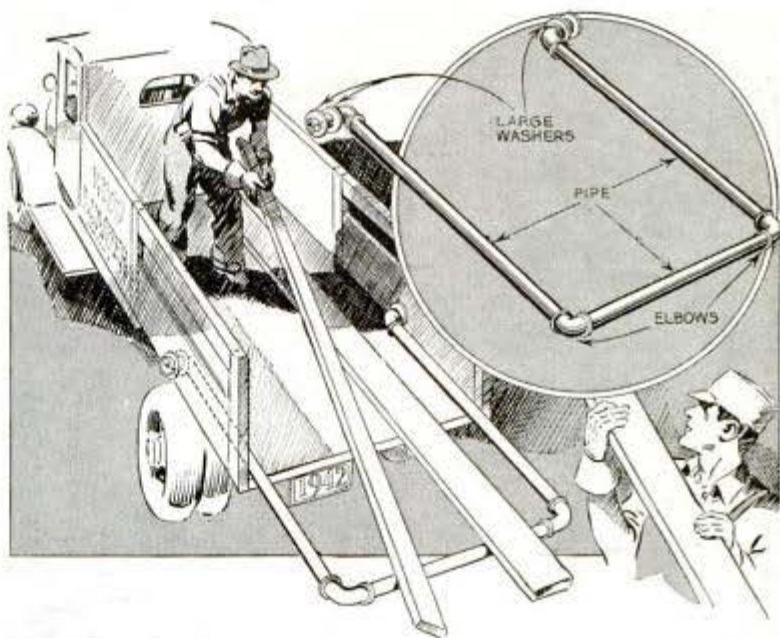

Combination Square and Yardstick to Mark Large Work

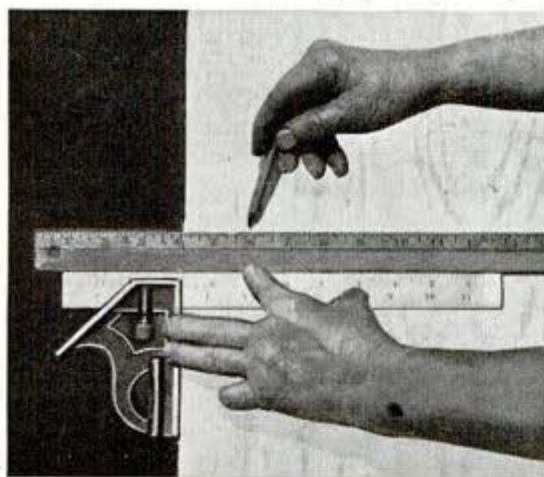

If a carpenter's square is not at hand when you want to mark a plywood panel, a yardstick and a combination square or try square will serve as a substitute. The blade of each square is just long enough to keep a yardstick straight when held against it firmly while marking across the stock as shown.

Tar Coating Prevents Chicks Picking Insulating Board

The habit of small chicks to pick at the insulating board on the side of their brooder can be avoided by coating the board with tar. Asphalt roofing coating is ideal for the purpose, and should extend to a height of about 20 in. above the floor.

Split Sections of Rubber Hose Make Rack for Lathe Chisels

A handy rack for your woodturning chisels may be made by splitting a length of garden hose and tacking the halves back to back on a shelf as indicated. The chisel blades wedge between the hose surfaces where they are easily removed or replaced.

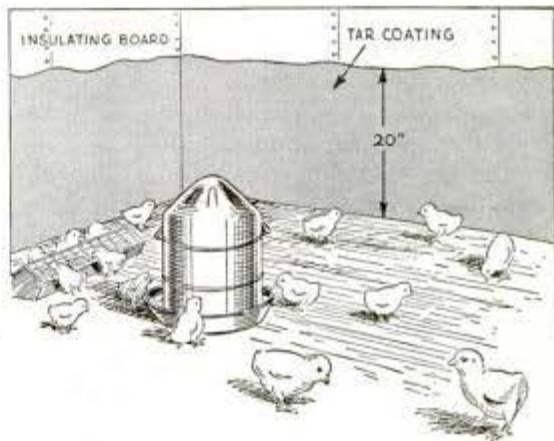

Metal-Turning.

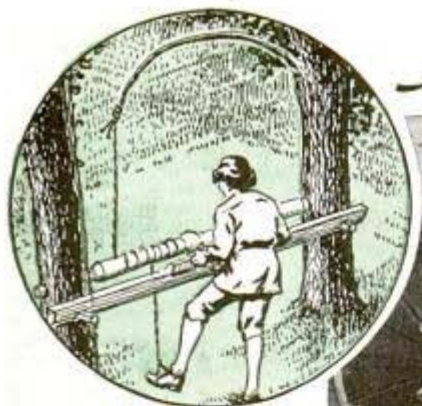

From crude beginnings such as the tree lathe, modern metal-turning lathes have developed to machines of high precision. Monster at right is what Henry Ford calls his "watchmaker's lathe"

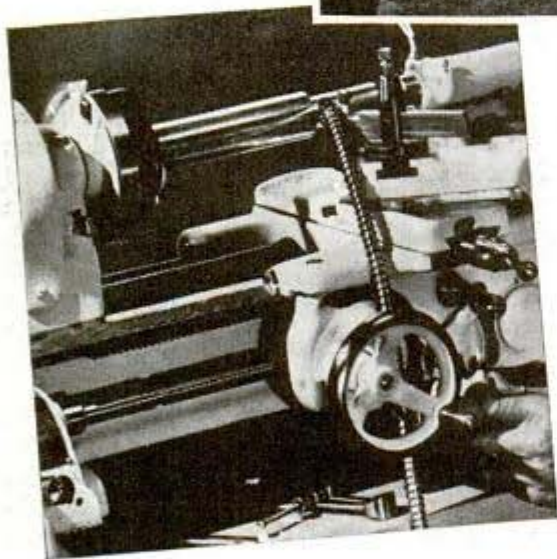
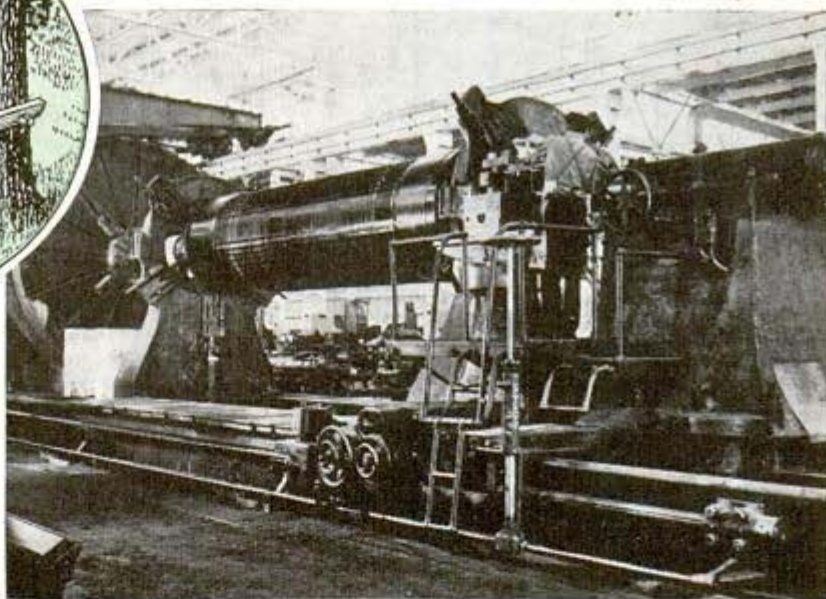

Part 3 of series dealing with basic machine tools and how to use them

AFTER getting acquainted with the parts of a metal-turning lathe and the fundamentals of lathe operation, the prospective lathe operator should undertake a serious study of various phases of lathe practice such as correct centering, methods of mounting work, technique of sharpening and positioning tools, cutting speeds, how to use precision measuring instruments, characteristics of metals to be turned, screw-cutting, taper-turning, boring, knurling, grinding, and the use and care of lathe accessories and attachments. Vol-

umes of information have been written on these subjects and obviously a comprehensive coverage of lathe practice cannot be contained in a single article on the subject. For this reason it is suggested that a number of textbooks be purchased, which will give you information covering the entire field. As this information is so readily available, and also because many articles have already been published in *Popular Mechanics* regarding various phases of lathe practice, this article will only give general data on terminology, methods of testing a lathe for accuracy, how to tackle some specific problems such as the turning of eccentric bearings on crankshafts, mounting small and large-size tubing, cross-drilling, taper-turning and filing, besides giving a few useful hints for lathe operators.

Keep your lathe accurate: It's a good idea to test your lathe frequently because its accuracy is of the highest importance. When testing the headstock and cross slide for squareness, some machinists regularly take a chip off the faceplate. However, it is preferable to make an 8-in. auxiliary faceplate such as is detailed in Fig. 2, which will prove valuable for many jobs besides making this test. It should not be less than $\frac{3}{4}$ in. thick. Two holes for locating pins and two for machine screws are drilled through both the auxiliary and the regular faceplate so that the auxiliary plate can be

LATHE SET-UPS

America's vital industries depend on thousands of lathe operators for work that must be turned to a high degree of precision. The lathe is one of the most important machine tools, essential in making all other power tools used in production lines

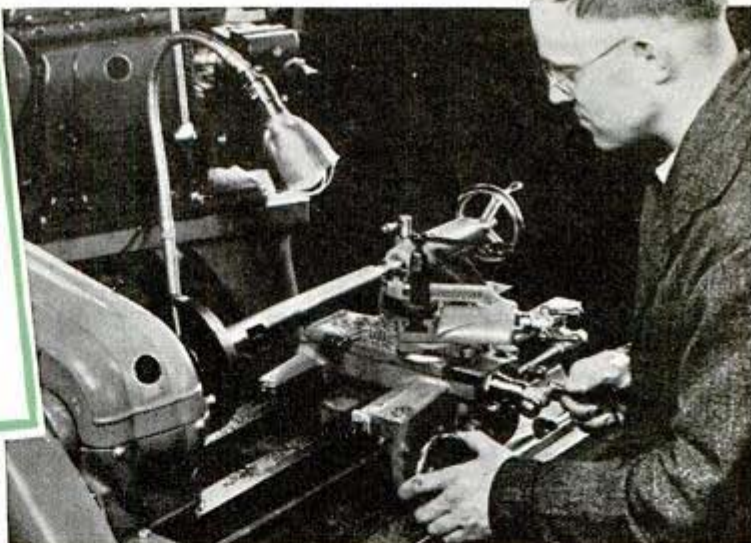

By H. J. Chamberland

attached easily in a few minutes. The two screw holes in the regular faceplate are tapped. After the plates have been assembled, a very light cut is taken across the auxiliary plate, the test for squareness between headstock and cross slide is made with a machinist's rule or straightedge and a piece of paper .001 in. thick, as shown in Fig. 1. The edge of the rule is held against the plate and if the strip of paper can be pushed under the rule at the center of the plate, the surface of the latter has a concavity. A .001-in. concave surface is permissible, but not a convex surface, which is indicated if you can slip the piece of pa-

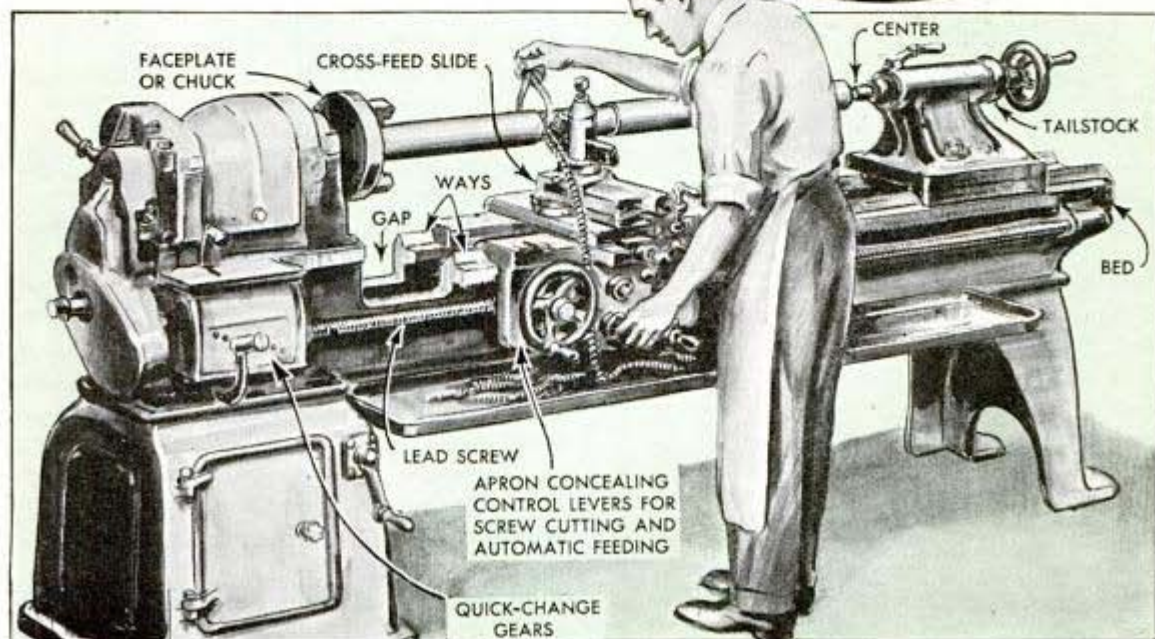
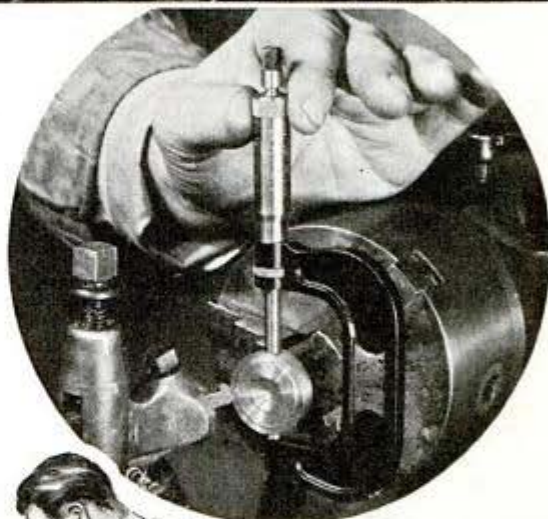

Check the lathe for accuracy

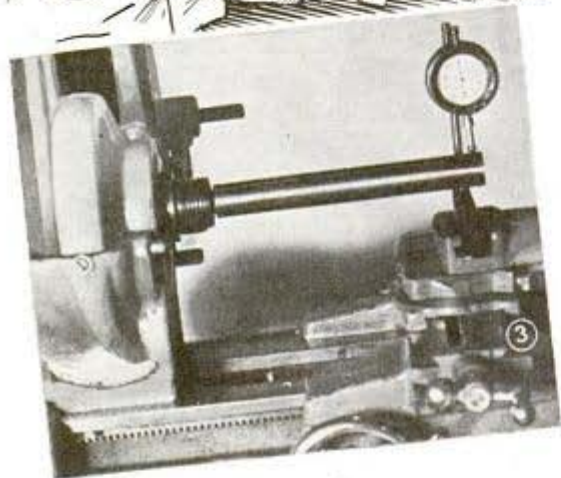
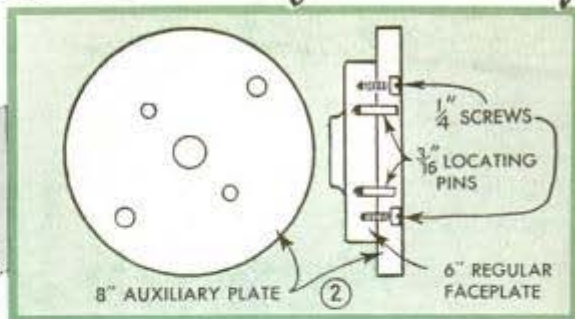

per under one end of the rule when the other end and center contact the faceplate snugly. If the test shows a convex surface, it will be necessary to make a careful check-up of the cross-feed slide and also of the headstock if the latter is not equipped with roller bearings.

In testing for accuracy of alignment between the headstock spindle and the ways, you can make use of an accurately finished bar fitted to the spindle bore as shown in Fig. 3. This test requires a dial indicator. The bar should be made as shown in detail A of Fig. 4. With the dial indicator attached to the tool holder of the carriage, the test should be made at both ends of the bar, vertically as well as horizontally. There should not be a variation of more than .001 inch.

Another testing bar such as shown in detail B of Fig. 4 is used to make the boring test. A cut about .003 in. in depth is taken across the bar, and if micrometer measurements show only .001 in. or less of taper, boring results should be quite accurate.

The headstock-tailstock alignment test illustrated in Fig. 5, is made with a bar such as the one shown in detail C of Fig. 4. This bar, which should be finished with precision, is used to check up wear of tailstock resulting from constant sliding action. A variation in height of .001 in. or less shows a very good condition in this respect. Although a .002 or .003-in. low tail point will not affect straight turning badly, it will be a handicap when tapers must be turned accurately. If you are in the habit of turning tapers by offsetting the tailstock, it is a good idea to check alignment after returning the tailstock to the center position, by means of a testing bar such as shown in detail D of Fig. 4, the bar being set on centers and its trueness checked with the dial indicator. Note that the testing bars A, B and C are tapered to fit the headstock spin-

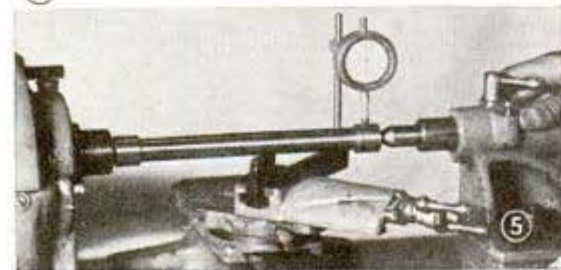
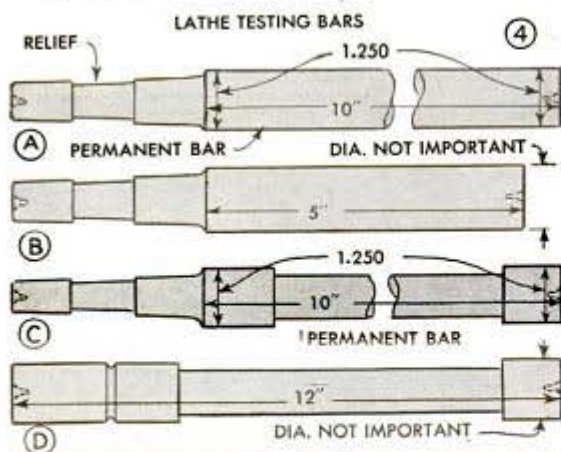

How to turn crankshafts

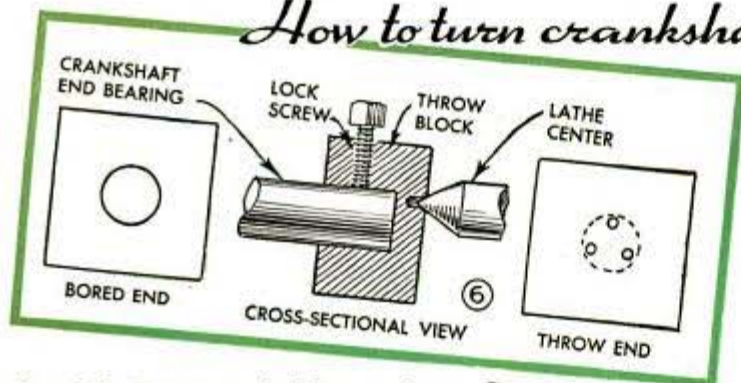

ble while D is intended for use between centers.

Turning crankshafts: Crankshafts made in large quantities are forged, but in smaller lots they are turned from billets with the use of throw-blocks. Throw-blocks consist of two identical and usually square pieces of steel machined as shown in Fig. 6, after which they are hardened. One side of these blocks is bored for the turned end bearings of the shaft. On the opposite side are center-drilled holes corresponding to the throws in the shaft and their offset in relation to its center. Single or triple-throw crankshafts such as shown in Fig. 7 can be turned by the procedure shown in Fig. 8. The idea is to scribe the required number of evenly spaced lines at both ends of the periphery. This is done by fitting the shaft with an improvised dog, using the dividing means of the headstock and then scribing with the end of the tool bit. These lines must intersect others on the ends of the shaft drawn radially with the centering piece of a combination square. Thus, a circle corresponding to the desired offset or radius is formed on both ends, and throw locations are prick-punched accurately and then center-drilled. It is well to undercut in order to differentiate intermediate bearings, end bearings and throw bearings. To turn a similar crankshaft, take the intermediate bearings first, main bearings B and C next, and shift to throw centers for D, E and F. Bear in mind that you must bolt some scrap piece onto the faceplate to properly counterbalance the work. Each throw requires a new balancing set-up. All throw-bearings and intermediate bearings should be rough and finish-turned with the same

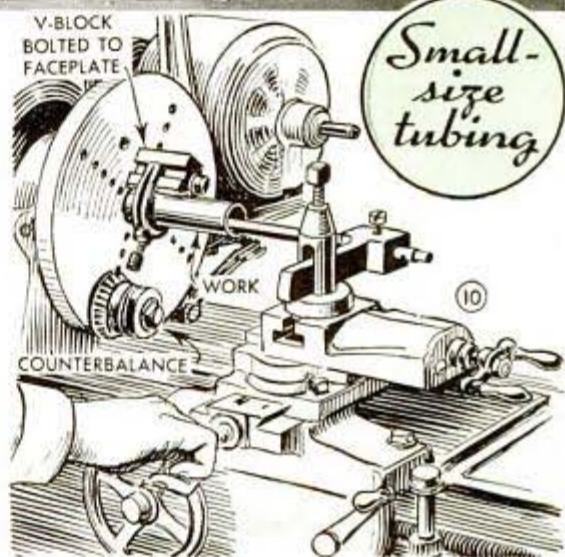
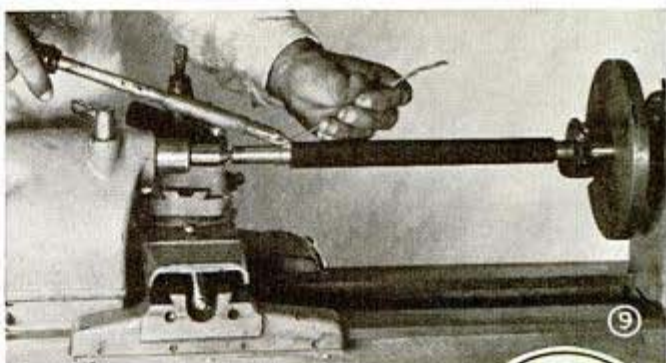
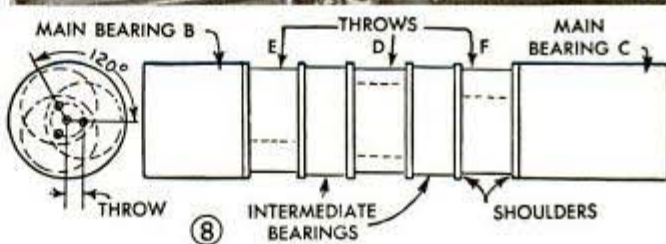

Small-size tubing

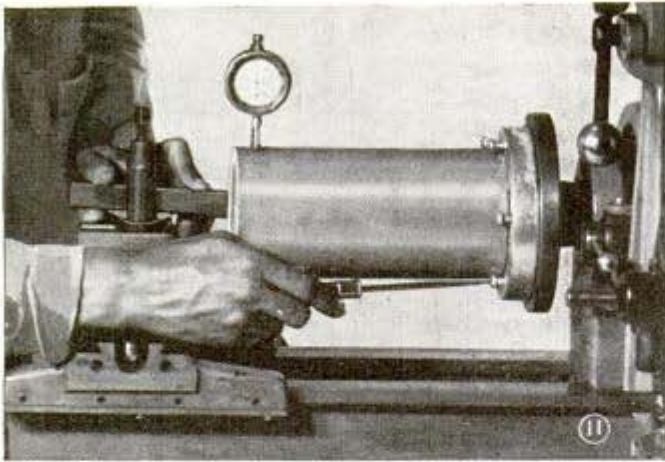

Large-diameter tubing

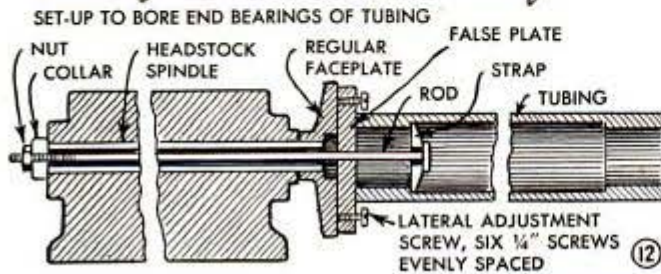

set-up. It is advisable to leave the end bearings slightly oversize previously and take a final cut. No counterbalancing is needed for concentric bearings.

Avoid waste by using tubing: Great savings in material are possible by using seamless steel tubing, which is available in many diameters and wall thicknesses to meet exacting industrial requirements. The economy lies in the fact that internal and external dimensions in premachined state are very accurate and an ample variety of sizes permits machining with a minimum amount of waste. Sections of thin-wall tubing to be machined externally can be soldered to an improvised mandrel as shown in Fig. 9. The mandrel must be turned perfectly straight to a very light press fit in the tubing. The ends of the mandrel are undercut for soldering convenience. A cut of .005 in. can be taken this way with accuracy. Lengths of thin-wall tubing not exceeding 4 in. can be lightly bored as in Fig. 10. The tubing is clamped to a V-block and the assembly is in turn trued concentrically on the faceplate. Note the convenience of the tapped holes in the supplementary plate

for bolting such parts to it. In such a set-up scrap parts are bolted to the plate to counterbalance the V-block.

Large-diameter and thick-wall tubing are frequently used for such items as collars, reliners, sleeves, bushings, housings, machine columns and hundreds of similar parts. For example, Fig. 11 shows a piece of tubing, 8 in. long, 4 in. in diameter and having a 3-in. bore. The hole was recessed previously, leaving bearings at each end. The purpose in the illustrated set-up is to bore the bearings $\frac{1}{16}$ in. larger, but separately, holding both in perfect alignment. This work is not complicated and is executed as follows: As shown in Fig. 12, the tubing is held to the false plate by means of the strap and rod, the latter passing through the head-

stock spindle and tightened with nut against a collar or heavy washer. The false plate should be about $\frac{1}{2}$ in. thick, smaller in diameter than the regular faceplate and should have a hub for a .005-in. play in a centrally counterbored hole in

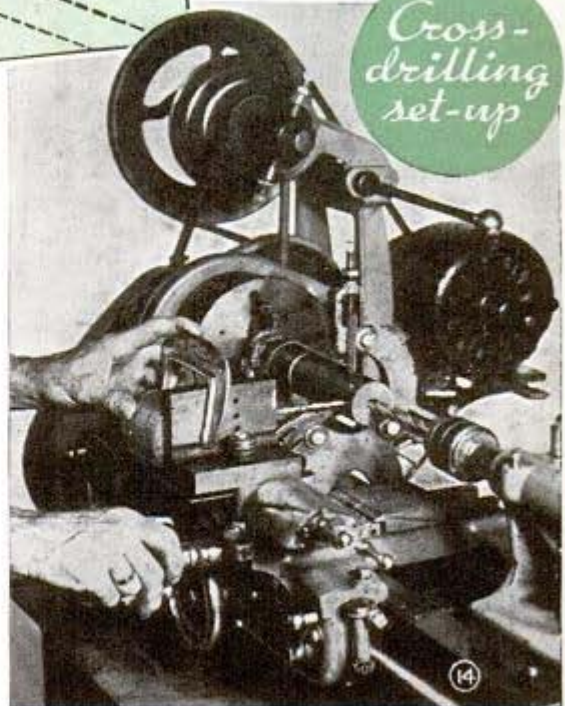
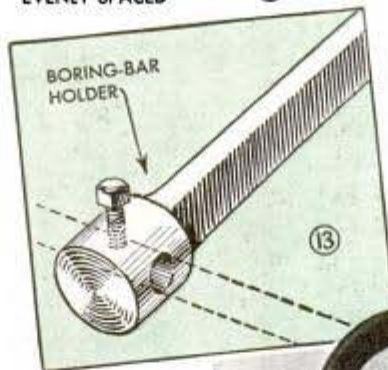

Taper turning

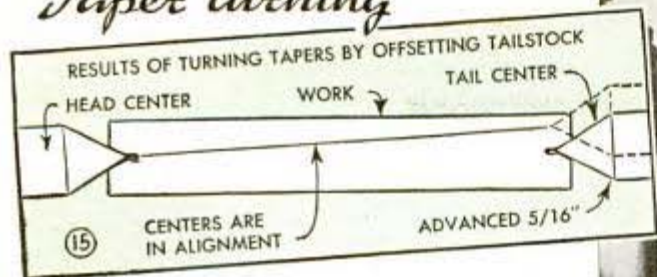

the faceplate. Also, the false plate has six 1/4-in. tapped holes about 5/8 in. from its outer edge for lateral adjustment screws. The tubing is tightened against the false plate just enough to true up with the dial indicator by tapping with a small chunk of lead. The end against the plate is trued first and then the indicator is moved to the front end. If there is any eccentricity here it is soon corrected by slight increase in pressure of one or two of the screws positioned opposite the high location on the work, which is done as illustrated in Fig. 11. After tightening the nut on the rod and again checking for concentricity, the hole is bored to desired size and the end of the tubing is faced. Then the cycle is repeated for the opposite bore, starting all over again after having released the screws bearing against the faceplate.

Boring-bar holder and cross-drilling set-up: A boring-bar holder is shown in Fig. 13. Such holders are most economically made of soft steel, cut to shape on a metal-cutting band saw. This saw is also of great help in cutting out disks that are to be turned to exact size in the lathe, thus eliminating considerable waste of metal in the form of chips. An arrangement for cross drilling is shown in Fig. 14. Using the conventional set-up to drill the end hole, the right-angle operation is done by chucking a drill in a small portable drill or grinder, bolting an angle plate to the cross-feed slide and then clamping the motor to the angle plate after centralizing.

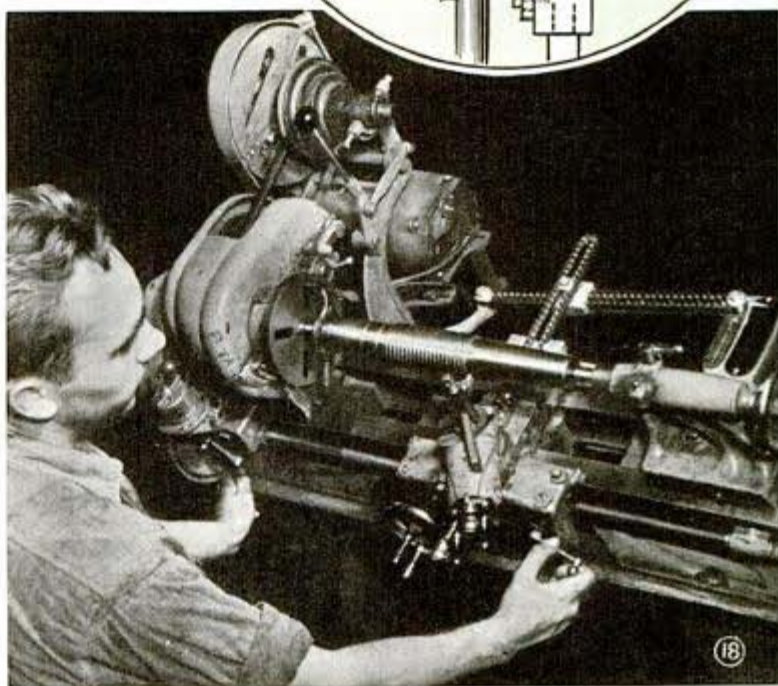
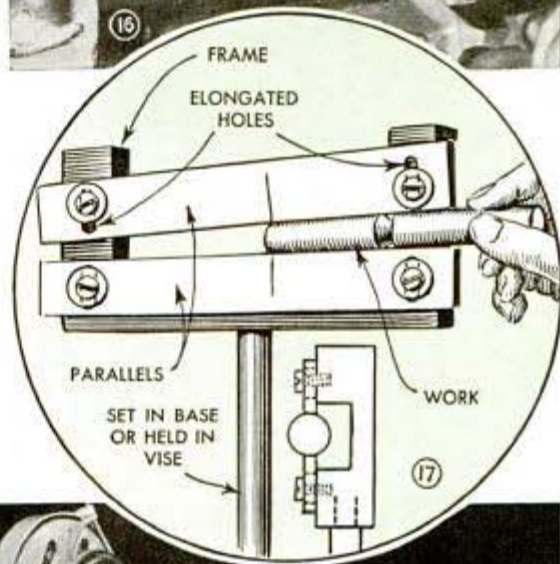
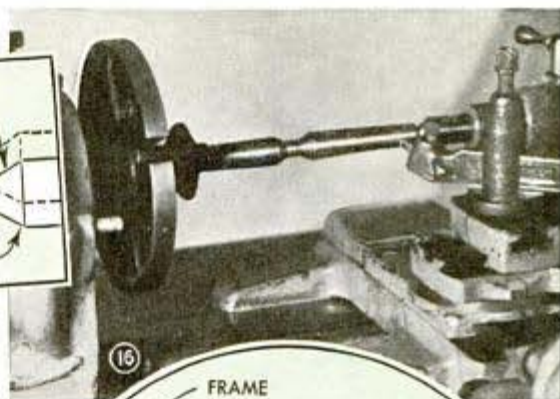

Any number of holes may thus be spaced accurately and drilled at any location on the periphery of a cylindrical part.

Taper work: Turning tapers is a very important lathe operation. Much of this work is done by offsetting the tailstock center but Fig. 15 shows what really happens when using this method, which obvi-

Filing

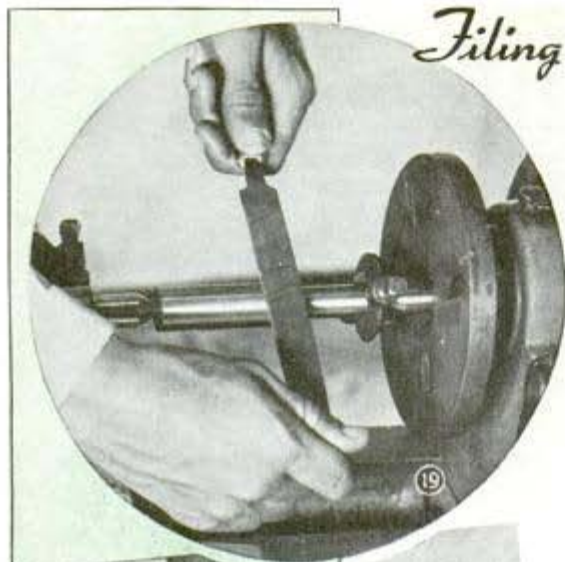

Water fed on grinding wheel keeps tool bits cool

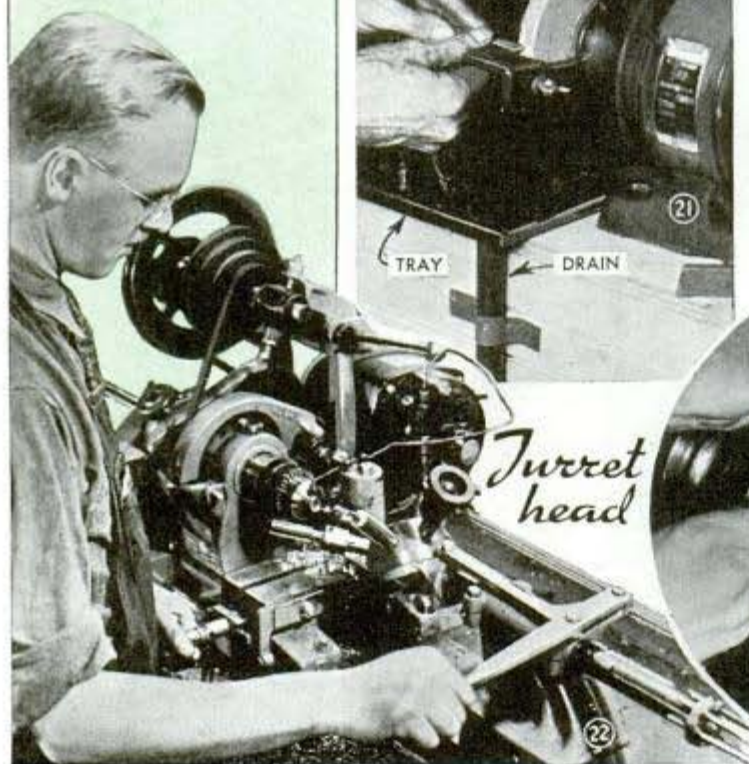
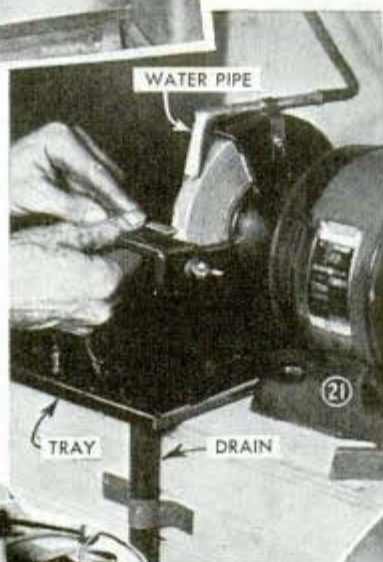

Turret head

ously is somewhat detrimental to machine centers and also to center holes in the work. Many machinists prefer to use the compound slide as shown in Fig. 16, which results in a better taper due to increased rigidity. First rough-turn the tapers and then allow about .010 in. for finishing cuts. Fig. 18 shows a lathe equipped with a production taper-turning attachment. This device is attached to the rear of the lathe and causes the cross-feed slide to travel parallel to its tapering adjustment.

Shown in Fig. 17 is a taper-testing fixture which is dependable and economical. The setting is done with a plug gauge or with taper shanks of drills, reamers or end mills. The chief requirement is that the bearing surfaces of both parallels be lapped into each other for accuracy. Recessing all taper shanks of tools such as shown in detail A of Fig. 4 is highly recommended, but it is not necessary to so recess lathe or other machine centers.

Filing in lathe and grinding tools: Fig. 19 shows the left-hand method of holding a file on work rotating in the lathe. This position may be somewhat awkward at first

but it is very effective in keeping your fingers away from the dog. Fig. 20 shows the usual position of the hands where they are likely to be injured.

Getting tool bits hot when grinding them and suddenly dipping them in water is not good practice; it is a sure way to damage a high-speed steel tool. One way to avoid this is to provide a wet-grinding set-up as shown in Fig. 21, in



which a stream of water is fed onto the grinding wheel and a shallow tray is provided underneath, the tray being connected to the drain. If you do not wish to connect directly to the water supply line, set up a 5-gal. can about 18 in. above your bench grinder.

Turret attachments: Fig. 22 shows a production attachment for bench lathes, known as a turret head. It holds a number of different tools such as a center drill, twist drill, reamer, tap, button die, etc., and saves considerable time otherwise consumed by replacing one tool with another when using a chuck. Fig. 23 illustrates part of a larger machine known as a regular turret lathe, which is a high-production tool.

Next month: How to Use a Bench Shaper

Flexible-Reel Slat Extensions Prevent Combine Clogging

Under certain conditions straw tends to collect on the dividers of a combine harvester and cause trouble by clogging the machine. To avoid this, one farmer screwed short lengths of old rubber belting to the ends of the reel slats as shown. The belting extensions were allowed to project just far enough to strike the inner sides of the dividers at each revolution of the reel. This sweeps the dividers clear at all times, preventing any accumulation of straw.

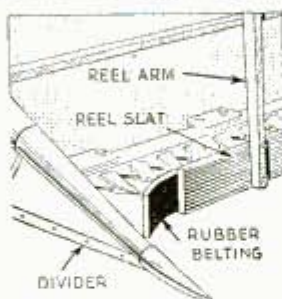

Supporting Bolts in Wet Concrete

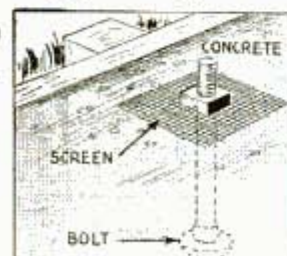

When it is necessary to anchor a bolt in freshly poured concrete, one contractor supports it in position with a piece of screen wire. First, the bolt is placed in the concrete in the desired position, then the wire is slipped down over the threaded end and the nut is started as shown. In this way, the wire serves as a float to keep the bolt in a vertical position until the concrete sets.

Trap Door in Hay Loft Marked By Suspended Auto Tire



Hung from the ceiling above the trap door in a hay loft, an old auto tire provides a good marker to prevent anyone from accidentally walking into the door. Even in the dark it is possible to locate the tire which is swung aside when passing through the trap door.

Ladder Serves as Handy Bench While on Small Jobs

Instead of hauling a workbench along when working on small jobs, one carpenter uses his ladder and sawhorses to make a satisfactory bench. The ladder is placed so that one end butts against a wall or building and a bench stop or hardwood block is screwed to one of the rungs for use in planing boards as shown.

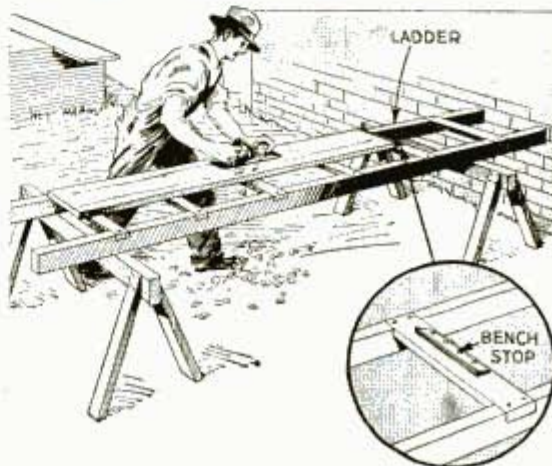

W. T. M. Concrete

Fabric "Brooms" on Hand Truck Clean Path for Wheels

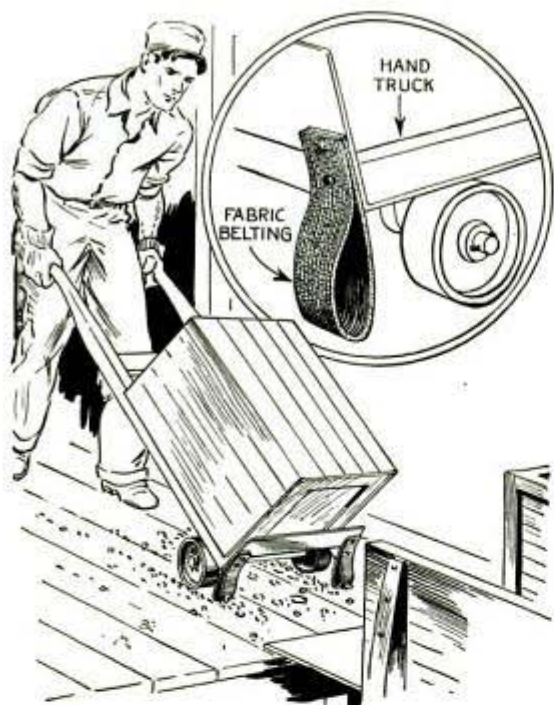

On loading platforms and floors where dirt or gravel may obstruct the wheels and make a hand truck hard to push, loops of

fabric belting can be nailed or bolted to the truck frame to clean the floor in front of the wheels. The belting loops should be suspended so that they touch the floor with a firm pressure when the truck is pushed.

Rocks Wedging Between Tires Avoided by Garden Hose

Placed between dual tires, a length of hose of suitable diameter will keep stones and other objects from lodging between tires on a dual-wheel truck. After cutting the hose to the right length, put a screen-door spring and a length of wire inside it. Make the spring-and-wire assembly a little shorter in length than that of the hose. Put the hose in place and then stretch the spring so that the wire can be fastened to it as shown.

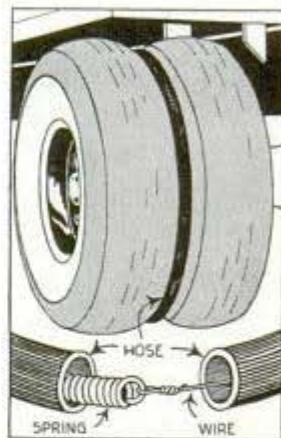

HOW TO MAKE YOUR CAR LAST LONGER

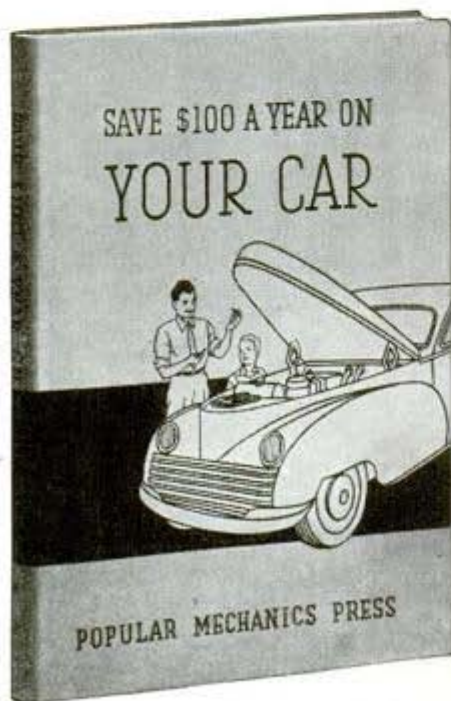

Here's how you can save money and still do your bit toward Victory, help conserve essential war materials and at the same time add thousands of miles to the life of your car. Popular Mechanics new automobile guide, "YOUR CAR," gives you hundreds of easy, practical kinks. Besides, it is filled with pictures and contains hundreds of time, money and labor-saving short cuts.

Would You Like to Know:

- How to double the life of your tires, as explained by experts?
- How to save money on your gas and oil?
- The secrets of picking a used car?
- How crankcase drainings can be put to practical use?
- How to cure electrical troubles?
- How to build and equip your own midget trailer?

All of these questions are simply and clearly answered in this thoroughly practical book, together with hundreds of others which you cannot possibly afford to miss. It has something for every driver, mechanic or garage man.

Order your copy today. Postpaid in U. S., \$1.25, or pay postman on delivery. Outside U. S. remit with order \$1.40. Your money refunded if you are not satisfied.

POPULAR MECHANICS PRESS, 200 E. Ontario Street, Dept. 383, Chicago, Ill.



Radio

Recorded Bugle Calls on P. A. System

By P. B. WOOLLEY

EVEN the bugler is mechanized in present day national defense. In the dimly lit hours of the morning, at one of the large Signal Corps School and Replacement Centers, a soldier reluctantly steps out of bed and goes to a turntable where he sets a needle on a recording and the martial strains of "First Call" blare over a 20-speaker public address system, arousing the Post.

With defense expansion requiring barracks to

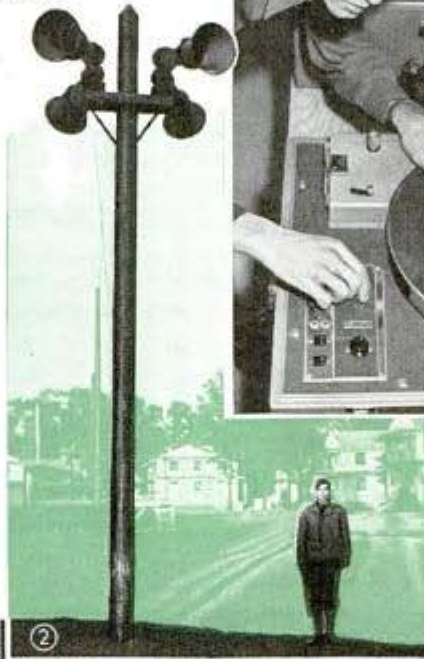

house thousands of men beyond normal peacetime strength, the area of such reservations has spread beyond the range of the powerful lungs of the chestiest buglers in the Army, despite the aid

offered by giant megaphones through which they formerly did their tooting.

The P. A. system beats out the meter of the soldier's life from early dawn until the stars twinkle to the rhythm of "Taps." Photo 1 shows Private Allen Richter starting a "First Call" recording; in No. 2 we see Private James Maratta, of Columbus, Ohio, patrolling his post in the area where one of the 4-unit speakers is located. Private Richter is at the main control board of the system, photo 3, where he is making an amplification adjustment in preparation for using the microphone. These soldiers and the P.A. system are on 24-hour duty and ever on the alert to carry out orders and inform the Post of any emergency which might arise.

The 20 all-weather type 100-watt speakers are placed at strategic points in the barracks area and near the parade grounds.



"Roll Your Own" All-Wave 3-Circuit Tuner



ANYONE can make a tapped-coil three-circuit tuner which is the heart of many simple receivers designed for beginners and experimenters. This popular type of tuner has primary, secondary and variable tickler windings. It is tapped for short waves as well as for standard broadcast reception, and flexible tickler-coil leads provide positive contact connections under rough handling. A cardboard terminal panel simplifies receiver circuit connections as each terminal is clearly marked.

This three-circuit tuner may be employed with a 350, 365 or 370-mmfd. variable tuning condenser, and it is the same type that is specified in beginner's receivers R-275, R-289 and R-298, described in recent issues of Popular Mechanics Magazine. The parts will be found in practically every radio experimenter's junk box, and cost only a few cents.

The coils are all close wound in the same direction, as detailed in Figs. 1 and 2. Standard size Bakelite tubing, with $\frac{1}{16}$ -in.

wall was used for the model; however fiber or even shellacked cardboard tubing of the same dimensions may be used instead of Bakelite if desired. The tickler coil is wound with a total of 52 turns of No. 32 enameled wire as indicated in Fig. 1. Drill a hole through the center of the small form to pass the $3\frac{1}{4}$ in. length of $\frac{1}{4}$ -in. 20 threaded brass rod, and then drill two small holes near each end of the form to anchor the winding. Scrape the enamel from the ends of the wire and thread it through the small holes. A 3-in. length of flexible stranded cloth-covered wire is then soldered to the anchored coil ends which are to go to the soldering lugs P and positive B on the cardboard terminal panel as shown in photos A and B.

Now prepare the large piece of tubing for the primary and tapped secondary coils. Drill the shaft holes $\frac{5}{16}$ in. down from the top end, and begin the secondary winding $\frac{5}{8}$ in. down from this top end. Drill two small starting holes, and leave 3 or 4 in. of wire at the start and finish of each winding. Wind the primary and secondary with No. 28 d.c.c. wire as

(Continued to page 183)



(A) Front view of completed 3-circuit tuner; (B) Rear view of terminal panel; (C) Schematic circuit diagram as used in 3-circuit receiver

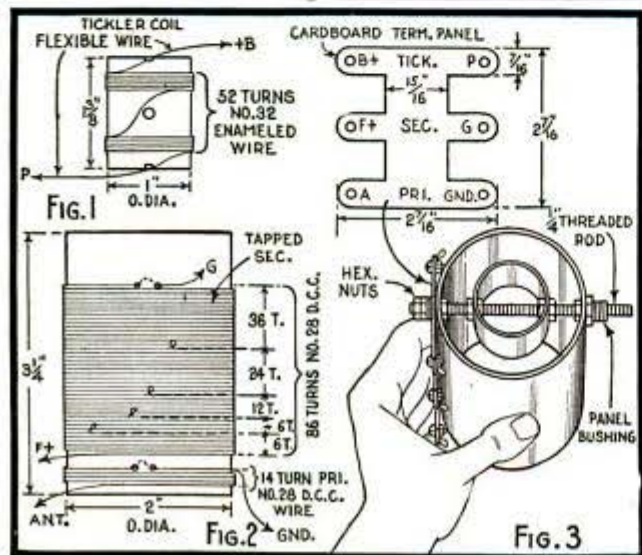
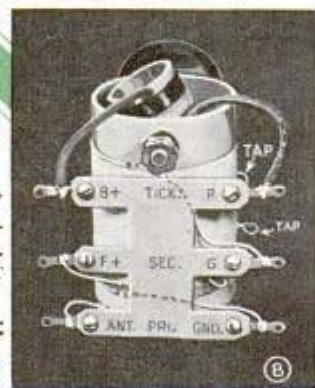
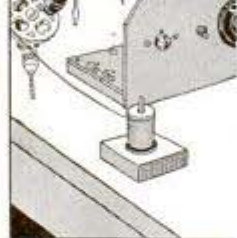

Helpful RADIO HINTS

(A and B) Multicoupler antenna system for apartment houses now includes FM with noise-free broadcast and short-wave reception. Roof installation details are given in Fig. 1. The radio receptacle multicoupler unit is shown in photo A mounted in a dual receptacle outlet for each apartment. The antenna transformer unit and other parts appear in photo (B). One of the largest eastern apartment communities has over 12,000 such radio outlets

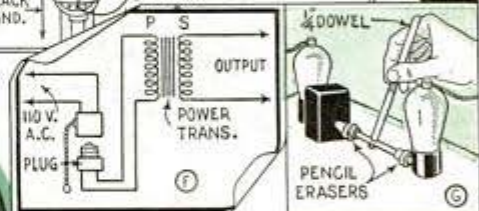
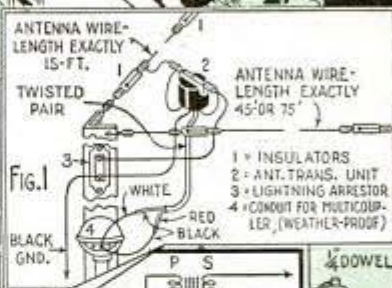

(C) Crystal pickup tone equalizer; connected between the pickup and amplifier, rotary switch provides 4-point control. (D) Aids for code students: No. 1 is a code practice oscillator with dynamic speaker; No. 2 an additional speaker and No. 3 a compact earphone audio oscillator



(F) "Dim-a-Lite" socket makes low-cost substitute for an expensive power rheostat for reducing line voltage to small power pack. Transformer primary leads are soldered to a screw plug. (G) Tapping hammer used to locate defective tubes and poor connections; check with resulting speaker noise

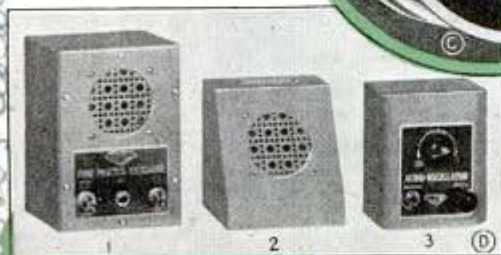

(H) Many set owners increase receiving range with this bi-directional two-antenna arrangement. Stations barely heard on one come in strong on the other. Connect switch arm terminal to receiver antenna post

(I) Handy 5-in-1 wire stripper tool. (J) Vibration type crystal pickup for oscillograph machinery testing



(E) Condenser nut wrench for easy removal or tightening of electrolytic condenser mounting nuts; 2-in. steel socket provides room for passing long lead terminals



Allen B. Hu. Mont Laboratories
Passaic N.J.

Blackout-Panel Oscillograph Minimizes Eye Strain



Designed for use under adverse lighting conditions or in total blackness when necessary, this oscillograph employs a specially processed steel panel treated with a non-radioactive luminous paint that retains its maximum luminosity for several minutes after exposure to ordinary light. The glow is the same color as the screen of the cathode-ray tube used in the instrument, thus minimizing eye strain.

'Tweeter' Speaker Added for FM



If you have a good, properly baffled speaker you can add one of the so-called tweeter speakers, which operate only on the highest audio frequencies, and build up a response in the high range for full reproduction of the wide band of frequencies available on FM broadcasts. Tweeter speakers are made in a number of different varieties and are mounted in the manner shown. When

combined with a 12 or 15-in. speaker in a bass reflex cabinet, frequency-modulation (FM) programs are correctly reproduced.

Portable Set of Advanced Design

Operating on its own self-contained batteries when desired, as well as when plugged into a light line, this portable receiver brings in not only local stations but short-wave radiocasts from foreign lands. It is equipped with two loops and a 5-ft. telescoping antenna.



Compact Phono Oscillator

When used with a modern record player, this tiny unit is capable of faithful reproduction through a radio receiver without wired connections. With this same combination, owners of home recording phono-radios can copy their favorite recordings.



Blueprints covering simplified radio construction articles in this and past issues are available for 25c each. Many popular tested circuits to choose from. Original detailed parts lists with names of supply sources, can be obtained from Popular Mechanics Radio Department upon receipt of postage.

NEXT MONTH—Two Tubes Equal Four in an Economy T.R.F. Set. One of a (V) home series designed with a minimum of parts along simple standard lines. Has built-in speaker, good volume and range, and operates on 110 volts a.c. or d.c.
Also—Home Receiver Self Helps, and, A Microtube Hearing Aid Amplifier.

Mechanics of a Blackout

(Continued from page 43)

safe. Most subways are close below the street surface, and would be much more vulnerable in air attack than the deep-level tubes of the London system.

Hotel managers scratched their heads in perplexity over the blackouts. Public rooms could be darkened by turning out lights or putting curtains over windows. Guests rooms, however, were not under the management's direct control. To pull the main switch and plunge the whole building into darkness was considered impracticable. Though effective in results, it would hardly be in accord with the tradition that guests must be handled with tact; moreover, there would have been a considerable element of actual danger in suddenly cutting off all lights and stopping the elevators. Instead, the hotels distributed blackout notices to guests asking them to extinguish room lights or to pull down the curtains. Watchers outside spotted the windows that remained lighted and hurried messages were dispatched to those rooms to put out or conceal the lights.

Fire and police apparatus are being equipped with shaded lights for use during alarms. In one city a guard was stationed at each fire alarm box in the downtown area to prevent any false alarms. At Seattle the police radio transmitter was cut off when a light switch was opened during the blackout. No messages could be sent from headquarters to the radio patrol cars. In another town, municipal authorities found they had 635 gas-burning street lights, each of which had to be turned off individually. At Toronto the fire sirens were used to give the blackout signals. When a real fire occurred in a blackout,

sirens of fire apparatus responding to the alarm were believed to be the "all clear" and many lights were turned on again.

While efforts here have so far been directed toward making blackouts complete, some authorities question the desirability of total darkness. Dr. Samuel Galloway Hibben, director of applied lighting for the Westinghouse Electric & Manufacturing Company favors "dimouts," leveling lights to the quality of moonlight.

"Total darkness during air attacks," he says, "can cause more civilian casualties than bombs. Normal eyes require about 20 minutes to adjust themselves to blackness so that the faint outlines of objects can be seen at close range. Lighting of less than moonlight intensity does not make it any easier to find the city from the air nor to identify particular spots, but it does help greatly in preventing accidents."

To maintain essential traffic during air raids it has been suggested that police carry portable, shielded traffic lights strapped to their shoulders. A band of white is recommended for the bodies of autos and trucks with cat-eye slits in headlights and small running lights suspended under the chassis. Fluorescent paint excited by ultraviolet light can illuminate subway entrances, police stations, bomb shelters, hospital entrances, fire hydrants, cross-walks, curbs and clothing. Another development is a low-power argon lamp with a reflector which would prevent the light being visible from the air.

Blackout or dimout, the problem is new to the people of the United States. We must learn what to do and what not to do when the sirens shriek.

Training the Glider Army

(Continued from page 85)

glider pilot maneuvers to keep his craft on or very near the ground until the plane gets into the air, keeping the cable connecting the two fairly taut. As the plane starts to climb, the glider pilot follows it until both are free of the ground.

A sailplane towed by an airplane, which is the method visualized for mass transportation of troops by air, must be piloted, just as is the airplane. Piloting skill for the glider operator is essential, in order to re-

lieve the airplane pilot of the excessive manual effort necessary for control of his ship, burdened as it is with the load at the other end of the cable. Moreover, improper flight or position of the towed glider is likely to endanger the towing airplane and cause it to stall, due to its low flying speed on a towing job. From the towplane pilot's standpoint, the first 1,000 feet of climb are the most dangerous. During this phase he

(Continued to page 164)

We promise each pipe lover he
Will cheer this great discovery!

YO HO! AND THE FLAVOR OF RUM!



It's new! It's grand! It's free of bite!
It packs and smokes and tastes just right!

YO HO! AND THE FLAVOR OF RUM!



It's thrifty, too... this smoke sublime...
The soft pouch only costs a dime!

YO HO! AND THE FLAVOR OF RUM!



The name of this tobacco treat
Is **FRIENDS** – and Friends, it can't be beat!

YO HO! AND THE FLAVOR OF RUM!



Try **FRIENDS**
the **NEW** Rum-Cured
Smoking Tobacco

51234

**GLUED JOINTS
STRONGER THAN WOOD ITSELF**

WORLD'S FINEST ADHESIVE

Get the same amazing results Franklin Liquid Hide Glue gives master craftsmen in finest woodworking concerns. This genuine hide glue in liquid form is used *as is!* No mixing, heating, preparation. Spreads evenly at normal room temperature.

Every drop works — no waste from evaporation, hardening, souring. Franklin Liquid Hide Glue is best, thriftiest, for all wood gluing.

AT HARDWARE DEALERS
or send 25c for quarter-pint can (Regularly 30c). If from Ohio, add 1c sales tax. Only one can to a person.

THE FRANKLIN GLUE CO.
1182 Cleveland Ave.
Columbus, Ohio

FRANKLIN
Liquid Hide **GLUE**
FOR ALL WOOD GLUING

Get New **FREE BOOK**

If no dealer in your town handles Cushman, send for free booklet, photos, full details, Low Prices.

100 Miles per Gallon
Cushman
with "Floating Drive"

Save Your Auto!—and cut gas costs 4/5ths . . . often 9/10ths! Comfortable, swift, safe transportation—cheaper than shoe leather! 3 models—(1) illustrated, (2) with Side-Kar, (3) 3-wheel with large front carrier! Ideal for deliveries, hauling light loads, etc. "Floating Drive" is automatic, smooth as liquid, no clutch or gear shift! WRITE for complete illustrated book!

CUSHMAN MOTOR WORKS, Dept. 15, Lincoln, Nebr.

GARDEN TRACTORS



SPEEDEX

6 H. P. riding type and 1 H. P. cultivator for the small tracts. Also small farm and garden tractor powered with Ford 4 cyl. motor. Low prices still in effect.

Before you buy—Write for FREE illustrated folder, covering all styles and equipments.

POND GARDEN TRACTOR CO.
Box 216 D45 Ravenna, Ohio

must maintain as much air speed and as shallow a climb as possible. If he stalls at this low altitude, due to insufficient air speed, he has little chance to recover.

But after 1,000 feet he increases his angle of climb, and flies close to the stalling speed, gaining altitude rapidly in this way. All the while the glider pilot must give his tow pilot every cooperation.

Air gusts affect the light glider greatly, so its pilot must watch the power plane ahead for advance warning, as the glider hits the same bump right on the heels of the tow plane. The glider pilot, thus forewarned, cushions the action of the bump by nosing up or down, keeping the tow line at as nearly the same tension as possible.

The most dangerous place for a sailplane during a climb is down and to the left behind a towplane, where the propeller throws the air it displaces. Here the slipstream and disturbed air create an area of turbulence so great that a sailplane that ventures into it is almost unmanageable. The best place for the sailplane is directly behind and even with the towplane, or slightly to the right and sufficiently high that the tow ship appears slightly behind the horizon.

Major General Henry H. Arnold, chief of the Army Air Forces, revealed something of the army's attitude toward gliding when he stated: "I have heard it said that the United States Army did not wake up to the military possibilities of gliders until after Crete. The facts are that we have been studying gliders and their possibilities for a long time, but it takes a long time to set a large machine in motion." He said further that gliders "may spell the difference between success and failure" in many military missions.

The Navy has ordered sailplanes utilizing a new material, a wood-impregnated plastic, said to possess the advantages of not picking up moisture or fungus growth; of being light, durable, and capable of being worked into any shape, and of having a "long fatigue limit" that enables it to withstand strains, twists, shaking and the like without cracking or chipping. Some of the Navy's gliders will carry 24 men each, some 12 men, and others two men. The larger ones will have a wing spread of 110 feet and gross weight of 12,000 pounds, while the 12-place craft will have a wing spread of 88 feet and weigh 6,500 pounds.

m 11

Sports Secrets in a Flash

(Continued from page 37)

is off center. These observed rotations, and hooking and slicing spins on the ball gave Spalding physicists the idea that if this rotational effect could be regulated it would be possible to produce just enough spin on the ball to correct the flight errors

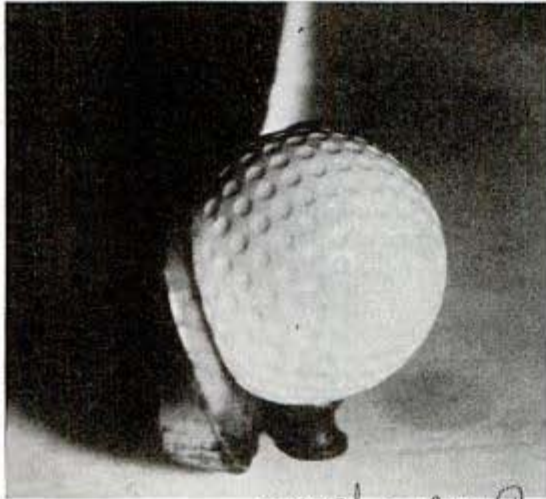

© Arthur D. Little, Inc. *30 Charles River Road Cambridge, Mass*
 3/1,000,000-second shot shows ball flattened by club due to off-center contacts. It was found that this could be done by a certain convex curvature in the club face.

Other high-speed pictures reveal to the player the futility of trying to gain extra length in drives through shaft whip at the moment of impact. Since the shaft is merely the means of imparting motion to the club head, the player's purpose should be to develop all possible speed before impact and then allow the club head to do the rest. The effort to employ the flexibility of the shaft to speed up the club head can only result in retarding the only effective striking force. During the short impact time, .0004 second, the head acts as a free projectile, the ball springing off the face before the backward bend appears in the shaft—and before the player could even feel the contact.

Another outgrowth of the Spalding research technique is use of multi-exposure photographs for comparison of golf swings. For instance, not long ago pictures of this type were made of an inexperienced golfer and of Bobby Jones. One point revealed was that the arc of Jones's backswing was wider than that of the poor player, result-

(Continued to page 166)

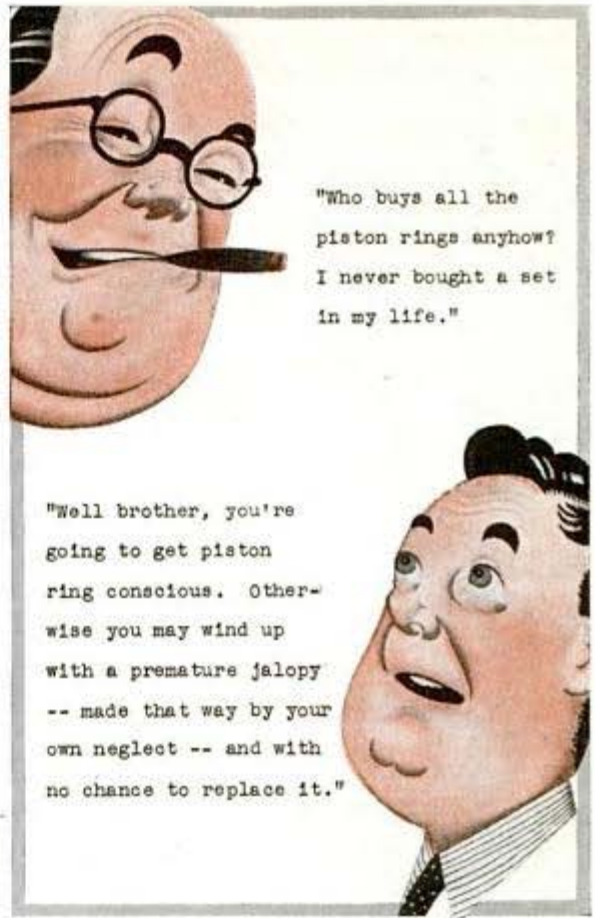

• Take my advice, friends, and join the smart millions who have long since learned that the way to insure long engine life is to install new piston rings—at first sign of oil-pumping or any other symptom of ring wear.

Get Hastings Steel-Vent Piston Rings. They are tough on oil-pumping; gentle on cylinder walls.

Any good mechanic can install them—quickly and economically.

HASTINGS MANUFACTURING CO.
HASTINGS, MICHIGAN
 Hastings Mfg. of Canada, Ltd., Toronto

Note to Used Car Buyers: Ask the dealer if it's Steel-Vent Reconditioned. It's a better buy if it is.



Sports Aid Preparedness

PLAY BALL — KEEP FIT

The President of the U. S. has given Baseball the GO signal for '42. American boys and men must be fit—healthy—strong—industrious. To work hard and get results, Americans must have time to relax, and Baseball, the All-American game, provides the outlet for relaxation and at the same time builds strong, healthy bodies.



DIMAGGIO



WILLIAMS



MIZE

Choose your baseball bats as the Champions do and insist on the Autograph of your favorite player and the Famous Louisville Slugger Trademark on the bat you buy. FREE. A copy of "Famous Slugger Year Book for 1942". Ask your dealer for a copy or send 5c in stamps direct to Department P-31.



LOUISVILLE SLUGGER BATS



BUILD THE U.S. "CONSTELLATION"

The oldest warship afloat, of the U.S. Navy.

Recommissioned August 24, 1940 by direct orders of President Roosevelt. Construction set with carved hull. Detailed blueprints and fittings may be purchased separately. Send 20c (coin) for 1942 catalog—52 illustrated pages.

A. J. FISHER

1002-1 Etowah Ave., Royal Oak, Mich.



"LET'S TRADE CAMERAS!"

Generous allowance on your camera toward a new or used model of your choice. Write giving description of present camera and tell us what you want. Write for free MOVIE or STILL Bargaingram. Dept. P

Bass CAMERA CO.
179 W. MADISON ST., CHICAGO, ILL.

ONAN ELECTRIC PLANTS ALTERNATING AND DIRECT CURRENT



Produce Current, same as City Power Lines, for FARMS, SCHOOLS, THEATRES, PUBLIC BUILDINGS . . . Operate Lights, Radios, Motors, All Appliances.

Over 40 STOCK MODELS—150 to 50,000 Watts.

Any Voltage—Any Frequency.

Combination A. C. - D. C. Types.

Manual, Full Automatic and Self-Starting. \$99 up.

Shipped—COMPLETE, READY for OPERATION.

THOUSANDS IN USE IN ALL PARTS OF THE WORLD

Write for Complete Details.

D. W. ONAN & SONS
1069 Royalton Avenue - MINNEAPOLIS, MINN.

ing from a more complete extension of the left arm. Noticeable also was a more effective windup of his hips, which brought the hands higher to provide more potential power. In addition, the radius of his downswing was shorter, through the retention of almost the full angle of wristcock during the early stages. And in the second half of the downswing, the uncocking of his wrists was seen to contribute to continually increasing speed of the club head. And finally, his relaxation after the hitting effort allowed the momentum of the swing to carry the club well around back of the neck at the finish. The poor player's swing, being much shorter after impact, indicated the player was still feeling tension.

The difference of club-head velocities near impact also was evident, for in Jones's swing the distance traveled by the club between flashes was almost 50 percent greater. The pictures were made at about 1/50,000 second, the stroboscopic light flashing 50 times per second.

Still another development is the Spalding Stroke-ometer chart, a patented method of analyzing multi-exposure photographs by means of polar coordinate plots which make it possible to tell at a glance to what part of the action any particular group of figures apply. A sheet of circular cross-section paper is laid on the multi-exposure photograph in such a way that the club head lies outside the cross-section paper. An appropriate scale is laid off on the paper and the numerical values of the property under consideration are plotted opposite the corresponding position of the club. For example, suppose the velocity of the club head is being plotted. Two positions of the head give the average velocity between these two positions. Suppose, for a given pair of positions, that the velocity is 100 feet per second. Then a point is laid off in the cross-section paper midway between the given positions of the head and at a value of the velocity which is 100 feet per second on the scale. A Stroke-ometer chart of Bobby Jones's swing, for instance, shows a steady increase in velocity for the downswing and a steady decrease for the follow through, with a sudden change at impact. Thus is revealed the symmetry of action desirable in golf.

In these, and many other ways are high-speed photographs helping to improve sports—both equipment and player.

FLUORESCENT WHOLESALE CATALOG **FREE**



The most complete fluorescent catalog—listing fixtures, accessories, kits for every type of fluorescent lighting—including newest kitchen and bed lamps—at lowest wholesale prices. New kit and diagram service makes it easy to assemble, install, and sell complete fluorescent for homes, stores, factories, offices and farms. Send for **FREE** catalog and special agents offer.

JACKSON FLUORESCENT SUPPLIES
427 W. Randolph St. Dept. 71, Chicago

NEW Grinding Attachment

For 8" to 16" Metal Lathes. Build It Yourself.

At last a precision grinder within your means. You save 2/3 by finishing our semi-machined castings on your own lathe. HURON handles both internal and external grinding. Accuracies to .00025". Mirror finish easily obtained. Grinds valves, pistons, bushings, shafts, hard or soft, Acids, lathes, rollers, Sharpen reamers, milling cutters. Does external drilling, taps, punches; scores of other uses, for home work, shops, garages, machine shops. Write for **FREE** illustrated folder and price list of supplementary items. Mention your lathe.



Semi-Machined Castings
Only \$6.45

Huron Machine & Tool Co., Dept. B, Yale, Mich.

GENUINE U.S. BARGAINS

O. D. WOOL BLANKETS (USED) . \$2.95
MCLELLAN SADDLES (USED) . 5.95
U. S. ARMY PUP TENTS (USED) . 2.50
U. S. MARINE PONCHOS (USED) 1.29
Thousands of Other Bargains in Military, Outdoor & Sport Goods for Hunter, Farmer, Scout Send 10¢ for 32-page catalog returned with first order.

A and N SUPPLY CO.
4720 LESTER ST. RICHMOND, VA.



EST. 1868

PUSH BUTTON CONTROLLED GAS TANK LOCK



NO KEYS—Electrically operated from dashboard. One model fits all cars including fender door type. Greatest thing out! Sells on sight! Fully guaranteed. Distributors, dealers, here is your money-making opportunity. Rush name for free literature.

SNAP-UP GAS CAP CO. Dept. k, ASHLAND, KY.

TRAILER BUILDERS · BUYERS · OWNERS

Over 80 pages! Beautifully Printed and Illustrated! Trailer Suggestions and Ideas galore! Catalog shows America's greatest line of Trailer Parts and Equipment at lowest prices. Everything from wheels to top. Rush 25¢ (in U.S.) today. Satisfaction guaranteed!

TRAILER SUPPLY CO. Box 350-A WAUSAU, WIS.

PLANS FOR NINE NEW JIM DANDY TRAILERS Ready

Build your own trailer! Send 10¢ for Jim Dandy's interesting new **TRAILER PLAN CATALOG** which illustrates and describes **NINE** new models including 6 modern house trailers, plus sport, camp, and utility trailers. Rush 10¢ (in U.S.) for Catalog today to **JIM DANDY, BOX 125-A, WAUSAU, WIS.**

FREE FIREWORKS

Write for our big **FREE** 1942 illustrated catalog and special gift coupon. Learn how you can earn your own fireworks or get extra fireworks without cost. Just send your name on a penny post card.

SPENCER FIREWORKS CO., 150 PM MAIN ST. POLK, OHIO

OWN A Printing Business

Cards, Tickets, Stationery, etc. Good profit in spare time. **PRINT YOUR OWN** greeting cards, movie titles, church work, etc. Save money. Easy rules supplied. Junior Press 58, Senior Outfits from \$17.38. Have home shop. Raised printing like engraving too. Sold direct from factory only. Write for free catalog and all details. **KELSEY, INC. X-37, MERIDEN, CONN.**

Class Pins and Rings

Artistic pins, rings and emblems for classes and clubs. Attractive prices 30¢ up. Finest quality, gold plated, silver, etc. Over 300 designs. Dept. N, **METAL ARTS CO., Inc. Rochester, N. Y.**

Wonder-Tone NOISE ELIMINATOR

Just attach to your radio (long, short wave) and enjoy reception free from distracting noises. Send **No-Money Pay Postman** 60¢ plus postage or send 60¢ and we'll send postpaid. Return in 5 days for refund if not delighted.

WONDER-TONE COMPANY, Dept. 16, 7078 N. Clark St., Chicago, Ill.

AGENTS 300% Profit SIGN LETTERS

For Store Fronts and Office Windows. Anyone can put them on. Free Samples. Liberal Offer to general agents. **METALLIC LETTER CO., 438 N. Clark St., Chicago**



A LAKE IS MADE

FOR LOVE

• **PADDLE** the peaceful paths of beauty — with rippled reflections and dreams. Spend peaceful days on the waterways. Glide through the glories of Nature.

An Old Town Canoe is easy to paddle. Quick to respond to the blade. True Indian lines — made steady and strong. Built for long years of hard use.

FREE CATALOG shows all kinds of canoes for paddling, sailing or outboards. Also outboard boats, including big all-wood family boats. Sailboats. Rowboats. Dinghies. Write today. Address **Old Town Canoe Company, 835 Main Street, Old Town, Maine.**

"Old Town Canoes"

BE PREPARED! LEARN TO SHOOT WITH BENJAMIN

MADE IN U. S. A.



HARD ACCURATE SHOOTING WITH CHAMBERED AIR
You can use new model **BENJAMIN AIR RIFLES WITH LEVER HAND PUMP** anywhere, for practice firing or just plinking, around the house or camping, fishing, hunting, etc., at lowest cost. Shooting force is adjustable with amazing maximum power and accuracy—no recoil or forward lunge to disturb your aim. **Bolt Action-Hammer Fire-Hair Trigger-Safety Lock-Hand Pump.** Single Shot BB with 1 lb. shot \$9.00; Single Shot Cal. .177 or .22 rifled—with 500 pellets \$10.50. Also a complete line of improved **BENJAMIN GENUINE COMPRESSED AIR TARGET PISTOLS.** "No License Required." Write for details and **FREE TARGETS.** **BENJAMIN AIR RIFLE CO., 895 Marion St., St. Louis, Mo., U. S. A.**

OTTAWA TRACTOR SAW



Falls Tree—Cuts Log
Fits rear power take-off shaft. Drive thru gear reduction. 18-in. stroke, 10-ga. blade. Economical, saws to profit. **FREE Circular and Price List**

OTTAWA MFG. CO., 927 Forest Avenue, OTTAWA, KANSAS

MECHANICS—

SPEED UP AUTO REPAIRS SEND FOR THIS FREE BOOKLET!

"Cures for Motor Car Ailments" contains 80 pages of short cut ideas, fully illustrated. Sent free—no obligation.

CHAMP-ITEMS, INC.
6187 Maple Ave. St. Louis, Mo.



CHAMPION SPARK PLUGS



*More Vital-
More Dependable
than ever!*



Spark plugs put the kick in an engine, and the men who drive and operate the nation's leading fleets of buses and trucks know this. They know, too, that it's costly to use any but the best. That's why most specify Champions, and a very good reason why you should too.



Your car is a real family asset, and a useful friend. Treat it as such and it will serve you faithfully and well during this emergency. Spark plugs are the heart and pulse of its engine so have them tested and cleaned at regular intervals. Replace old, worn-out spark plugs with new Champions.



Operators of fleets also know the importance of maintaining equipment at peak efficiency and regularly inspect, clean and adjust spark plugs. Since the start of a national competition among fleets, for economy and efficiency of operation, Champion-equipped fleets have won a big majority of the awards.

TO SAVE GASOLINE • KEEP YOUR SPARK PLUGS CLEAN

The Race of the "Ironing Boards"

(Continued from page 69)

had spent \$20,000 on the hunt in vain. They were given up for lost. About this time, soaked and bedraggled, in they came. It seems their boat had conked out, shipped a lot of water, and they had made the oil slick by bailing bilge water. Finally, a small fishing boat came along and the two boys hitch-hiked a ride, towing their disabled boat behind. They had gone far up the coast and in due time returned!

The Ironing Board Derby has been run just for the sheer sport of it—for the satisfaction that only a champion knows when his tired muscles rally for one last effort, and he comes in the exhausted victor. Two large cups are presented each year, one for the rider and one for the boat operator.

Bomb Rack Streamlined in Hull Lets Seaplane Release Load

Difficulties of jettisoning bombs from the big, long-range flying boats are overcome by a bomb rack just patented and assigned to the Boeing Aircraft company. The bottom of a flying boat's hull cannot be pierced by doors to the bomb bays, and moving heavy bombs out over the wide sides disturbs the equilibrium of the plane and may spoil the aim. Three Seattle engineers devised a way to arrange the bomb racks with their lower ends projecting over the sides of the hull, the upper ends sloping inboard to form an inverted V. The rack is enclosed in the sides of the plane, achieving maximum streamlining. Downward openings are just wide enough to let the bombs fall free, and there are guides to keep the bombs parallel as they roll toward the discharge openings.

Model Builders Attention!



	V	V-2	V-3
Hex	1/2"	3/8"	5/16"
Thread	3/8"-24	1/4"-32	1/4"-32
Thread Length	7/32	7/32	5/32
Weight, Grams	8	3 1/2	2 1/2

Actual Size V-Plug

Champion spark plugs for model gas engines give the same dependable performance as regular Champions. Sillment sealed. Sillimanite insulator. Alloy needlepoint electrodes for easy starting. One piece construction.

CHAMPION

SPARK PLUG COMPANY • TOLEDO, OHIO

*Phos A. W. Nelson
Rea. Stith. J. A. Endres, Seattle Wash*

21295

How to Make Your Car Do

(Continued from page 95)

up at full speed saves gas, brakes, and tires.

For maximum mileage the tires must be kept at recommended pressures or even a few pounds above. Don't drive on car tracks and don't take turns at high speed. When a tire company test driver is told to see how rapidly he can wear down a set of tires he hunts for a high speed road that has plenty of sharp curves. Cramping the wheels against curbs and even excessive road shocks tend to move the front wheels out of line. The wheels should be checked for alignment occasionally, and at once if you notice the rubber is wearing unevenly.

To keep your body paint in good condition, keep it clean. Dirt picks up the heat of the sun and transmits it to the finish. A dust cloth can be used to remove a slight film of dust and the car should be washed if dirt and mud has dried on it. Always wash and polish the car in the shade, when the car is cool, and never use a gritty cleaner on the finish. Most chrome plating is very thin and should be washed with water instead of with a cleaner that may wear it down.

Almost no one bothers about keeping the engine clean. Those who do, find the engine stays cooler in summer. In addition they have less trouble with dirt and dust in the generator, starter, and distributor. Once the whole engine compartment has been thoroughly steam-cleaned, you can keep it clean by scrubbing it with solvent, using an old brush. To be safe, leave the hood up afterward and be sure all the solvent has evaporated before starting the engine again. Under exceptional conditions air-borne dust in the carburetor has ruined an engine in less than 1,000 miles. Few people drive in such adverse conditions, but everyone should keep the air cleaner clean. It is recommended that the air screen be removed every 2,000 miles, soaked in gasoline to remove the grime, and then dipped in oil and drained before replacing.

The chances are you have known all of these hints, and the chances are, also, that you have failed to observe all of them. If you resolve to spend enough money on your car to keep it in good shape, and drive it reasonably, you will be surprised at the unexpected service it will give you.

DON'T WORRY

about war-time difficulties
in replacing cracked or loose
household or auto equipment
... repair with SMOOTH-ON

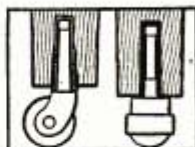
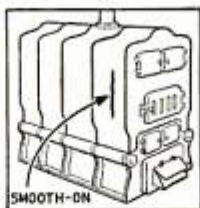

These days, you **MUST** keep your plumbing and heating systems, automobile, household utensils, tools and hardware in good condition, because you will find it hard or impossible to replace them until after the war.

But don't worry on that score because, with a can of SMOOTH-ON No. 1 on hand, you can take care of many repair jobs all around the house and car. SMOOTH-ON seals cracks and stops leaks in boilers, radiators, tanks, heater, piping, etc. It also tightens loose fixtures, handles, bolts, hardware, etc. Any handy man can apply SMOOTH-ON because it is easy to use and does not require dismantling of parts, heat, special tools, or previous experience.

SMOOTH-ON has been a dependable standby of repair men and mechanics for over 45 years, and today it is more essential than ever—a real necessity in every house.

Buy Smooth-On in 1 1/2-oz., 7-oz., 1 lb., and larger cans from your dealer or if necessary from us. For your protection, insist on Smooth-On, proved by 47 years on the market.

FREE SEND THIS COUPON

and we will mail you, **ABSOLUTELY FREE**, a copy of our latest Smooth-On Handbook. 40 Pages packed with useful information on how to make lasting repairs. Contains 170 helpful diagrams. Mail it today!



Smooth-On Manufacturing Co., Dept. 37
570 Communipaw Ave.,
Jersey City, N. J.

Name.....
Address.....
5-42.....

Do it with **SMOOTH-ON**

21405

IF YOU'RE IN THIS FIX..



P. W. WILL FIX IT

BROKEN FURNITURE can often be repaired permanently, quickly with **PLASTIC WOOD**! Resets loose drawer pulls and casters, too. In cans or tubes at Paint, Hdwe., 10¢ stores.



HANDLES LIKE PUTTY—HARDENS LIKE WOOD

Mows and Trims Lawns

in One Simple,
Easy Operation



Save Time
and Labor with a

MONTAMOWER

Tired backs and aching arms just don't happen to users of Montamower. All the drudgery and noise of lawn mowing is done away with. No dead weight to push and pull. Instead, just 7 pounds of live mechanism that first gathers then cuts the grass closely, smoothly, and to the correct height; no matting; no streaking; no clatter; no rattles. Cuts a 16" swath through long grass, dandelions, spike grass and weeds. Cuts right up to walls, fences, trees or posts; leaves no fringes to be trimmed by hand. Cutters are self-sharpening. Built to last many years. Guaranteed. Thousands in use. Sold direct from factory. Costs little. Write at once for guarantee information and literature.

MONTAMOWER DISTRIBUTING CO.
329 Houseman Bldg. GRAND RAPIDS, MICHIGAN

"Tracer Bullets" of Science

(Continued from page 63)

A similar technique is employed to measure the thickness of the oil film that protects metal sheet from which tin cans are made. The average thickness of these films is about six-millionths of an inch. In other words, about 300 layers of the oil would about equal the thickness of a human hair. To measure the oil film, a small amount of a sodium compound that has been made radioactive is mixed with the oil before it is spread onto the metal. When a Geiger counter is held near the sheet, the number of radioactive explosions indicates the thickness of the oil.

Tagged atoms are likewise used to study diffusion of silver, the manner in which atoms wander about inside a piece of the metal. Knowledge of this phenomenon is valuable to such industries as metal plating, since it can reveal how much one metal will "soak" into another. Careful measurements of the motion of silver atoms in solid silver and in solid gold have been made by Dr. W. A. Johnson.

Chemical measurements can be made with the aid of tagged atoms, the tracers being employed to determine the exact amounts of chemicals required to complete various chemical reactions. For example, when magnesium chloride is added to phosphoric acid and ammonia a solid ammonium phosphate is formed. The problem is to measure exactly how much magnesium chloride is needed to consume all the phosphoric acid. Its solution begins with "tagging" some of the atoms in the phosphoric acid. As magnesium chloride is added slowly to the acid, the phosphorus atoms are released from the solution or mixture as solid material, leaving fewer atoms. A Geiger counter permits measuring the radioactivity of the solution after each addition of magnesium chloride, thus determining the percentage of phosphorus atoms remaining. With each measurement the radioactivity decreases until a point is reached where it nearly vanishes and further additions of magnesium chloride produce no further reduction. In other words, all the phosphorus has been released. Plotting the results on a graph, the scientist is able to determine the exact amount of magnesium chloride required to combine

(Continued to page 172)

Now Only \$5.95

REAL ENGINE VALUE

The G. H. Q. is a miniature gasoline engine that really operates. Over 15,000 sold in the last year. Now is your chance to buy the New Improved 1942 model kit for \$5.95. Absolutely complete with coil, condenser, plug, instructions, etc. Only a screwdriver needed. For boats, planes, midget cars, etc. All parts guaranteed. Send only \$1.— Shipped Collect C. O. D. same day. Send for FREE circular or 6c for Jumbo catalog of hundreds of plane, boat and hobby items.



GHQ MOTORS, Dept. B, 40 East 21 St., New York, N. Y.

2 Enlargements GIVEN!

ROLLS developed and printed. Two beautiful professional "Life-time" enlargements given with 8 prints. Or 16 sharp, clear prints. Or 8 large over-size prints, (deckle-edge if desired). 25c post-paid. Credit for unprintable negatives. Reprints 3c each. Fast 1 day service. Satisfaction guaranteed.

35MM Prices: Ultra-fine grain developed and vapo-rated—3x4 inch prints—36 exposures \$1; 18 exposures 60c.

FREE MAILERS MAY'S PHOTO WORK GUARANTEED
Dept. P-5, LaCrosse, Wis.

BURN YOUR NAME ON TOOLS

WITH THE ARKOGRAF

PROTECT YOUR TOOLS FROM THEFT
Write with electricity any name or design on the hardest and finest tools and instruments, or any metal, like writing on paper with pen or pencil. Complete outfit \$3.50—Prepaid Anywhere. Interesting illustrated circular free. Write today. Agents wanted. ARKOGRAF PEN CO., 3927 S.E. Stark St., Portland, Ore.



TENNIS SAVE on our NEW LOW PRICES

• Gut Tennis and Badminton Strings direct from factory to you. • Silk Tennis Strings • Visas & Frames • Tennis Equipment.

H. E. WILLS CO. Catalog FREE
1047 W. 47 St. Dept. PM-52 Chicago



FREE LITERATURE FOR TRAILER BUILDERS

New up to date facts on world's most reliable parts, axles, hitchies, draw bars. Used by U. S. Gov't. and largest trailer Mfrs. Easy to build in spare time. Complete working Blue Prints only \$1.00. Write for Free Literature.

HAMMER BLOW TOOL COMPANY, Dept. 105, Wausau, Wis.

DO YOU

high as \$50-\$100 weekly after a few weeks home training—not medical or chiropody—no further capital needed, no goods to buy. 47th year. Write for free booklet.

Stephenson System of Foot Correction
28 Back Bay, Boston, Mass.

BUILD ARC WELDER FROM OLD GENERATOR

For Light or Heavy Work. 30-200 amperes. Complete PLANS 35c. Send today and we'll include FREE our 1942 Catalog.

LEJAY MFG. CO., 1347 LeJay Bldg., Minneapolis, Minn.



BRUSH PLATING OUTFITS

for autoparts, reflectors, faucets, bicycles. No tanks necessary. Free particulars.
GUNMETAL CO., AVE. M, DECATUR, ILLINOIS

See WOODSTOCK TYPEWRITER

Victory efforts at Johnson have all but stopped the production of Sea-Horse outboard motors. For the most part, we are engaged in the manufacture of essential defense items in which precision and DEPENDABILITY are highly important—and for which Johnson facilities, training and fine equipment are ideally suited.

Your Johnson dealer is in touch with the motor situation. He can help you with service—and possibly motors, new or used. See him. He is listed under "Outboard Motors" in your classified telephone directory.

JOHNSON MOTORS
400 PERSHING ROAD
WAUKEGAN, ILLINOIS
Johnson Motors of Canada
Peterboro, Canada

The new Sea-Horse Handy Chart, with complete details on 1942 Johnson motors—sent

FREE!

JOHNSON SEA-HORSES FOR Dependability

New IMPROVED Electric MOTO-SAW

New Blade Holder Faces Blade 4 Ways • Multiplies Capacity

Safe as a Hand Saw JUST GUIDE IT!

More like magic than any tool you ever saw. Imagine an electric scroll saw only slightly heavier than a hand roping saw... a tool that takes no effort to run, no pressure to feed. Works at any angle—on big assembly jobs or on the tiniest piece you can hold in your fingers. Runs 7200 strokes a minute... so fast the blade seems to stand still. Sturdily built... only two moving parts... never needs oiling. Easily cuts intricate designs—so smooth it eliminates sanding. Novice or craftsman, a thrill awaits you when you get a Moto-Saw in your hand.



U. S. Patent 2233802
Other Patents Pending
DREMEL MFG. CO.
Dept. 112-E
RACINE, WISCONSIN

No Limit to Length of Stock It Will Cut. Saws to Center of 19" Widths. It's fast... cuts on an average of 1 ft. per minute up to 1/4" medium hard wood. Operates on 110-120 V. 50 or 60 cycle alternating current. If your dealer does not yet have MOTO-SAW, send \$4.85... we'll pay postage. Or send \$1. pay postman balance plus postage. **MONEY BACK** if not delighted after 5 days trial.

FOR 27,000 R. P. M. INSIST ON A GENUINE

MOTO TOOL

100 Tools in One
*Has shock-proof bakelite case.
*Fan-cooled motor can't overheat
*Has oil-less bearings
*Dynamically balanced armature



Here's your guaranteed quality! The handiest tool in the shop or home. Use it daily for model making, repairing, carving wood or plastic, etching glass or metal, touching up dies, sharpening, routing, sanding, drilling, and on a hundred other jobs. Higher speed does better work and saves cutters. **Model One**, wt. 6 oz., with chuck and 1/4" collet, only \$9.95. **Model Two**, wt. 13 oz., \$16.00. **30 DAY TRIAL—Money-Back Guarantee.** If your dealer does not have Moto-Tool, order direct... we pay postage if you send cash. Or, send only \$1, pay postman balance plus postage. New catalog of tools and accessories **FREE**

KIT NO. 1 with 23 high grade accessories and Model 1 Moto-Tool in \$17.50 hardwood case

KIT NO. 2 same as above with Master M o d e l 2 Moto-Tool... \$23.50

DREMEL MFG. CO.
Dept. T-112-E
Racine, Wis.

21405

DURO *Super Value* 8 INCH TABLE SAW

A NEW SAW that has been specially designed to meet the requirements of those who need a big rugged saw to perform heavy duty work for a moderate investment.

Includes many extras which usually add many dollars to your cost. Table extensions are included to give working surface of 27"x18". The guard, splitter and anti-kickback are furnished with the machine—not as extras. All standard equipment is included such as rip fence, mitre gauge, depth gauge and tilt gauge. Includes same quality materials and same precision workmanship as our production saws. Spindle operates on New Departure Ball Bearings.

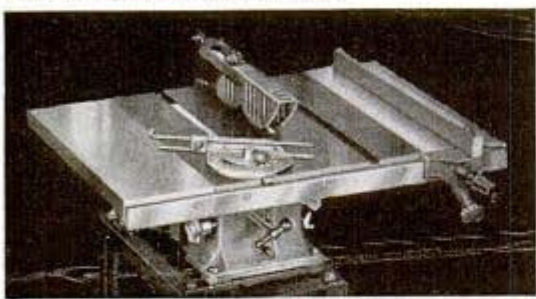

DURO METAL PRODUCTS CO
DEPT. PM-6-2653 N. KILDARE,
CHICAGO, ILLINOIS
SUPER VALUE

BRONZE FOUNDRY *Schools and Home* Workshops

Make your own castings of aluminum, copper, bronze, silver. Foundry sets are available in three sizes including 2400 Deg. F. blast Furnaces. \$17.50, \$24.00, \$34.50, f.o.b. Kansas City. Free Circular.

KANSAS CITY SPECIALTIES CO.

P. O. Box 6022, Dept. P-21 Kansas City, Mo.

PAINT STRIPING TOOL **ONLY \$1.00 POST PAID**

Try it! See the Added Beauty

With this NEW TOOL (not a brush) everyone can now draw lines with paint. Used on autos, models, toys, tiled walls, cabinets, furniture, linoleum floors and all home workshop projects.

Send only \$1.00 for complete tool for painting a 1/16" wide stripe, including adjustable guide, operating instructions, etc.

Tool uses paint, enamel, lacquer, etc. Patented interchangeable tips are available for wider or narrower stripes.

Every Painter and Craftsman Should Own One
Send for your tool today. Use it. If you are not satisfied that you have added character as well as beauty to your work, return the tool and we'll refund your money promptly.

Dealers: Write for literature, etc.
WENDELL MFG. CO.

2531 N. Ashland Ave. Chicago, Ill.



GERSTNER TOOL CHESTS

save tools and time. Free Catalog to machinists and toolmakers.

GERSTNER TOOL CHESTS
442 Columbia St. Dayton, Ohio



IT'S FUN TO MAKE THINGS OF WOOD

CONSTANTINE'S MASTER MANUAL TELLS HOW TO DO IT

Beginner or expert will find many helpful hints and tips on veneering, woodfinishing, cabinet making, carpentry, etc. Constantine Master Manual for Woodworkers and Big Bargain Book describes and illustrates over 100 different kinds of wood and 980 different items for you. ALL AT MONEY SAVING PRICES. A source of supply for anything in wood regardless of quantity. Send only 25c in stamps or coin, 25c refunded or credited on first order so Manual costs you nothing.

ALBERT CONSTANTINE & SON, INC.
791-E E. 135th St. New York, N. Y.



completely with the amount of phosphoric acid he has originally. Application of radioactive tracers to improve methods of chemical analysis has been worked out by Dr. Alois Langer.

The tracer bullets and the atom-detecting instrument are useful to medical research men interested in the paths followed in human bodies by various food elements, such as iron, copper, iodine and sodium. For example, if the scientist wants to learn where sodium goes, he mixes a little radioactive sodium with the sodium in the salt a person sprinkles on his mashed potatoes. Then as digestion and assimilation proceed, the Geiger counter traces the progress of the salt through the person's body to its final resting place as a part of the body structure. Since this artificial radioactivity is only temporary, it fades in a few days without causing any bodily harm. But its use as a tracer of food elements has become a valuable tool in the study of certain ailments, such as goiter, tumors, anemia and leukemia. Work on medical applications of radioactive materials is now going forward in many research laboratories. Foremost among them is the University of California where the work is headed by Dr. John Lawrence. Other important contributions are being made in the laboratories of the Harvard Medical School and the Massachusetts Institute of Technology.

Similarly, by putting tagged atoms of carbon in plant food and tracing them, biologists have discovered that plants can make sugar in the dark—not just in sunlight, as once supposed—although the process is slower without light.

In locating radioactive atoms of phosphorus in steel, a simple "camera" made of a tin can, two small brass disks and a screw clamp was employed. Although it had no lens, shutter or other parts usually regarded as essential on cameras, the tin can recorded on photographic film the rays from the tagged atoms, thus revealing their location. This was done by molding a small disk of steel containing the tagged atoms, or tracer bullets. In a darkroom a piece of photographic film was laid on each side of the steel disk, two small brass disks or plates were placed outside the film, the whole was clamped together, then placed in the tin can to keep out all light. The next morning, the can was opened and the

21405

film developed, revealing light and dark blotches caused by rays from the tracer atoms. The light areas corresponded with little air pockets, or blow-holes, in the steel disk, showing the phosphorus had concentrated on the surfaces of these holes.

This simple method can be used to reveal the location of other substances besides phosphorus. For example, steel also contains small amounts of sulphur, carbon, manganese and silicon. Any of these substances can be made into tracers with an atom smasher.

But it is not always necessary to make atoms radioactive in order to trace their course. An atom sorter on wheels, known as a portable mass spectrometer, has been devised for sorting out by weight the molecules and atoms which are the building blocks of all matter. Research has shown that almost all elements contain a mixture of atoms falling into two or more weight groups. These weight groups are called isotopes, some of which are abundant, others very scarce. The atom sorter can detect and measure the percent of atoms in each of these weight classes, even when they are as scarce as one part in 100,000. Mass spectrometers have been the subject of research in university laboratories for many years but only recently has there been available for general use a portable self-contained instrument. This was developed in these laboratories during the past two years by Dr. J. A. Hipple.

The atom sorter does its job by shooting the atoms around a bend in a glass vacuum tube up to a speed of a million miles an hour. Just before they start they are given an electrical charge. Then they pass through a chamber where high voltage acts on the electrical charges and shoots the particles to the other end of the tube. The curved end of the tube is encased in a powerful electromagnet which bends the paths of the atoms. The lighter the atom or molecule, the more its path bends. At the other end of the tube, the percentages of particles of different kinds are measured with electric meters.

One practical use for the portable atom sorter is as an accurate, high-speed gas analyzer for oil refining and prospecting. There are possibilities that the instrument may be used to discover new oil deposits. Another field is the analysis of gases for heat-treating and hardening steel.

in your workshop

AVOID ACCIDENTS



Cone-shaped pein spreads the rivets

Heat-treated, toughened eye to prevent breakage

Handle kept tight by take-up wedge

Added driving power thru properly centered weight back of broad striking face

Oblong eye takes full-sized sturdy handle

Scientifically tempered face crowned and chamfered to overcome chipping

PERFECTED

BALANCE

HERE'S the answer to better work, faster work, safer work! You can't afford to take chances of injury thru chipping. **Protect yourself with quality —the Quality of Plumb Ball Pein Hammers.** See *all* the features of this perfectly balanced hammer with scientifically tempered, crowned and chamfered face. These mean better *control*, *safer* striking power, *longer* life. Play safe! Insist on Plumb Quality!

FAYETTE R. PLUMB, INC. • PHILADELPHIA, PA.

PLUMB

HAMMERS • HATCHETS • FILES • SLEDGES • AXES

2 1178

POP'S ORIGINAL "SCHOOL OF FILING"



They Shoot on Sight

(Continued from page 76)

bridge or fortress. The third dimension cannot, of course, be translated to paper; but to the amateur viewing a Trivision film it appears almost alive, certainly alive with intriguing possibilities for both military and civil use.

In the Signal Corps photography school, rookie cameramen learn the technique of operating cameras, the chemistry of the profession, mounting prints, even the choosing of photogenic subjects. In the training film laboratory the men are divided into groups of scenario writers, animators, film editors and cameramen; each receives highly specialized training in his line. Graduates are finally assigned to photographic companies throughout the army. Some are sent to "cover" maneuvers, although training films generally require special arrangements on location, with close attention to details. If engineers are to learn bridging operations from the film, if gunners are to learn correct firing practice and tank crews the tactics of the "heavies," the demonstration on the screen must be perfect. Some subjects lend themselves especially well to animated drawings: thus the interior action and recoil mechanism of an artillery piece can be dramatized, or the invisible chain of events inside a vacuum tube can be given life, or a plan of battle can be pictured on an animated map. Slow motion, too, can be employed to teach an efficient march step, the scaling of obstacles, traffic flow or proper handling of arms.

The night has a thousand eyes, and some of them belong to the Air Forces. Flying photographers at Lowry Field are trained to use high-speed and high-altitude cameras, bomb spotters, infrared and telephoto cameras, color and reconnaissance cameras, and the new technique of night shots from the air by the light of flare bombs synchronized with the shutter.

Signal Corps photographers have been moving in a steady flow from Fort Monmouth's school to assignments throughout the army. Whether it's a pictorial history of War in the 'Forties that Uncle Sam wants, or a quick range on an enemy gun emplacement, or a sound movie to train aviation mechanics or tank crews, an army armed with lenses is ready.

IN hundreds of machine shops, "Pop" is the name affectionately given the foreman or superintendent who is interested in the advancement of the men in his charge as well as in the efficiency of the work under his control.

He knows that one of the stepping-stones to a higher pay job is thorough knowledge and skill in the use of files. "Filing is an art with many techniques," says "Pop." And that's not hard to believe, since Nicholson makes more than 3000 kinds, sizes and cuts of files.

In addition to a wide range of standard files, war and private industries use many Nicholson or Black Diamond Special-purpose Files with which every mechanic and apprentice should become familiar. Some of the ones on which *FREE Technical Bulletins* may be had by writing us are: Stainless Steel, Aluminum, Brass, Plastics, Die Makers, Foundry, Die Casting, Shear Tooth and Lathe Files.

Nicholson and Black Diamond brands are obtainable through hardware and mill-supply houses.

**NICHOLSON FILE CO., 23 Acorn St.
PROVIDENCE, R. I., U. S. A.**
(Also Canadian Plant, Port Hope, Ont.)



**NICHOLSON
FILES** FOR EVERY
PURPOSE

**NICHOLSON
U.S.A.**
MADE IN U. S. A.



★ FOR VICTORY ★
BUY DEFENSE BONDS
AND STAMPS

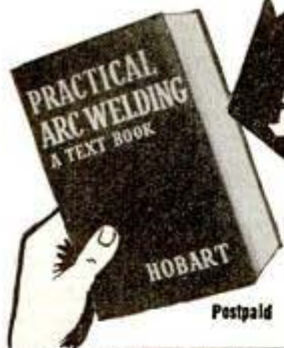

You Need this NEW and "UP-TO-THE-MINUTE" ARC WELDING MANUAL

of all the latest TECHNIQUES, MATERIALS and PROCEDURES

New 1942 edition, 516 pages, 512 pictures—all that's new in arc welding. No welder or student can afford to be without it—answers all welding questions. Worth hundreds—5 day Free Inspection. Order now. **\$2.00**

Learn why Hobart is the outstanding welder.—Why you should know more about its advantages. Write for your catalog today.

Get this New and Complete Catalog FREE!

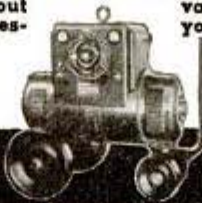

HOBART

"Simplified" ARC WELDERS

HOBART

"One of the World's Largest Builders of Arc Welders and Equipment"

ORDER Your Books at ONCE!
Just clip this ad with your name and address together with your check or money order. **MAIL NOW!**

Thompson
BEATS
the World
on BOATS



Better Built Lower Prices

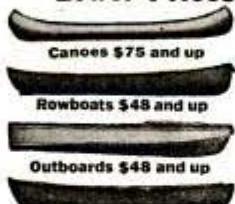

Canoes \$75 and up

Rowboats \$48 and up

Outboards \$48 and up

Light "Car-Top" Boat

THOMPSON BROS. BOAT MFG. CO. (114)

113 Elm St. CORTLAND, N. Y.

Safe Boats With Full Length Spray Rails
Keep passengers perfectly dry—even at high speeds. Catalog also shows today's seven most popular models of sailboats. Two big factories. Prompt shipment. **CATALOG FREE**

Write for your copy. State kind of boat in which you are interested.
213 Ann St. PESHTIGO, WIS.
(Write to either place)

argus

ann arbor michigan

Free CHOOSING YOUR CAMERA
Write for this 32 page booklet



FOR GOOD PICTURES

FINE AMERICAN MADE CAMERAS

ALL OUT FOR

Victory

WITH

HARLEY-DAVIDSON

Motorcycle clubs all over the country are volunteering for civilian defense duty. Members proudly use their rugged, dependable Harley-Davidsons for messenger and errand service, escort and patrol duty, and render valuable aid to other volunteer branches. Harley-Davidsons' greater flexibility makes them the ideal vehicles for this type of service, and their unmatched economy conserves gas, oil and rubber for the nation's Victory Drive.

See your Harley-Davidson dealer — learn about the superior performance of these world champion motorcycles. Also look over his special values in reconditioned models.

MAIL COUPON NOW

HARLEY-DAVIDSON MOTOR CO., Dept. P, Milwaukee, Wisconsin
Send FREE copy of big 24-page "Enthusiast" magazine filled with thrilling motorcycle pictures and stories. Also literature on the latest Harley-Davidsons. Stamp is enclosed for mailing cost.

Name

Address

HARLEY-DAVIDSON
MOTORCYCLES

Arming Civilians for Defense

(Continued from page 31)

the guards should be instructed how and when to burn the gasoline. Or the gasoline can be made temporarily useless by dumping sugar, linseed oil or similar substance into the tank. Water will not do; it simply sinks to the bottom.

Home defense units preparing to face an invasion should learn first how to take cover. Tom Wintringham, organizing Britain's home guards, told his people the Boy Scouts could teach them how to find cover and to move with as much use of cover as possible. Raw troops, he said, are eager to fight and expose themselves too much. Learn to dig a hole when lying on your stomach, and to make a valuable trench out of a useless straight ditch by cutting slots in the walls so that a man can hide from lengthwise fire along the ditch.

It was an army of farmers that fought the American war for independence; an army of home guards. Civilians today could not hope to oppose a mechanized invasion, but they could help with delaying tactics. And they can learn something about the use of weapons—a rifle or shotgun, a pistol, some sort of hand grenade. To use any of these weapons correctly you must be able to gauge distance to the target.

The hand grenade is a useful weapon for anyone. Any man or woman who can throw a brick should be able to do effective damage with a grenade. Actually a brick is not a bad instrument to start practicing with; lob it well up in the air to get distance.

The local defense units in England were taught to press the trigger of a rifle without jerking or shaking the barrel. They practiced lying prone, or crouching behind sand bags. They learned two essentials about pistols: first, never to assume that "it isn't loaded"; second, don't expect to affect a man at 20 yards range with a pistol unless you are a good shot already. Unless you are thoroughly used to a pistol, all you can do is wait around a corner or behind a door where you know an enemy is likely to come, then fire at point-blank range. Men who have never fired a pistol, however, can fire fairly well as soon as they learn how to judge distance, to aim correctly and to squeeze the trigger gently and firmly.

Several methods of halting tanks have already been described. One other, some-

times useful, is the antitank ditch. Dig a trench with one wall vertical and six feet high, the other wall slanted so that from ground level to the base of the vertical wall is about 15 feet. Bolster the vertical wall with cement, rails or ties, otherwise the tank could roll down the slope and grind away with its tracks until it has brought down enough earth to give it something to tread on and climb up. The sloping wall should be toward the anticipated tank attack. Near any tank trap or road block there should be bomb shelters.

But ahead of the tanks come the motorcyclists. If they can be spilled off their machines, get to them quickly; grab the rider's tommy-gun or pistol before an armored car comes along. If a motorcyclist is stopped down the road and there are no heavier vehicles in sight, the scout should be stalked with hand grenades.

"No tommy-gun can possibly hit you at 500 yards," Wintringham told the English volunteers. "At 200 yards it will not hit you if you are quick; at 100 yards or less it will cut you in half with bullets in two seconds. Keep this in mind when tackling parachutists or infantry armed with this weapon." Machine guns are dangerous at a half mile or less but cannot drill through a strong brick wall, three feet of earth or any solid barricade.

A house can be defended by knocking loopholes that command the ways of approach. Buckets of water should be handy, and blankets or curtains to cover the windows. These should be hung somewhat away from the windows so that the blast from a shell or hand grenade will not drive the glass through them. Two thick mattresses or a thick brick wall will stop a bullet. The home defender should be able to get into the attic, and to the roof if possible. Ground floor windows should be heavily barricaded, and stout timbers held ready to bolster a door against a hand grenade attack. And there must be some way for the defenders to escape; a "crawl trench" just deep enough to crawl along is sufficient.

These are the new ways of war civilians around the world are learning. Behind the armies are the homes, and in these homes men and women are preparing to stand off the invading tide as it reaches their door.

To "Keep 'Em Rolling" HE NEEDS YOUR CRESCENT WRENCH

Photo by U. S. Army Signal Corps



Any American would be glad to give all his tools to our fighting men. In the field, good tools like Crescent are almost as vital to victory as guns. Our men have these tools in abundance. That, perhaps, is the reason your tool kit is minus those Crescent Tools you tried to buy. Our war plants also use Crescent Tools by the thousands. They and our soldiers, sailors and marines come first. That's the way every American wants it. In the meantime, turn your tool money into Defense Stamps and Bonds—they're tools for victory too.

CRESCENT TOOL COMPANY, JAMESTOWN, N. Y.

(Photo at left) An Army Mobile Repair Shop puts a tank back in fighting trim, quickly, efficiently.

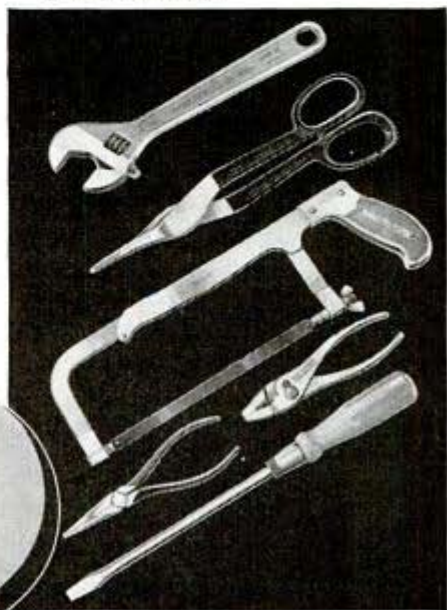

CRESCENT TOOLS
Give Wings to Work

CRESCENT & CRESTOLOY WRENCHES, PLIERS, SCREWDRIVERS, SNIPS, HACKSAWS, ETC., ETC.

KEEP THAT SKILLET HOT!

Fish for Sure With a P & K Lure

Bring on the Big Boys! Hit those Hide-Aways—with WHIRL-A-WAY! Here's P & K's newest lure; a skillet filler, and a killer for sure!

Fish takes only the hook; lure slips ahead on strike. Made of tenite. Only \$1.00 each.



(U.S. Pat. No. 1972697)

Tested under every condition, Whirl-A-Way proves a sensation with hardest fishers. It whirls, flashes, wiggles, spins—it really whips 'em with class and power to burn.



Simply reverse hooks to make weedless.

Your choice of eight colors: Red & White; Black & White; Black; Yellow Perch; Green Scale; Spotted; Pickie; Spotted Frog.

P & K NIGHT CRAWLER

Another honey! Soft rubbery substance makes this fish fooler wiggle and squirm as natural-like as the real thing. You'll want the Night Crawler in your tackle box. Only \$1.00 each.

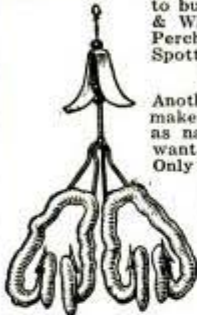

P & K FLY ROD LURES

FROG; CRAB; SHINER; TUMBLEBUG; MOUSE; GRUB WORM; CRICKET AND MANY OTHERS. GET P & K'S NEW 1942 4-COLOR CATALOG FOR FULL LINE DESCRIPTION AND PRICES. SEE THEM AT YOUR DEALER'S NOW!

PACHNER & KOLLER, INC., 2326 WEST 69th ST., CHICAGO, ILLINOIS

SEND FOR FREE CATALOG

With Life-Like Illustrations in 4 Colors, Description and Prices.



TESTED AND PROVED LURES AND ACCESSORIES

FOR OUTDOOR THRILLS!



Indian SPRING FRAME MOTORCYCLES

Only Indian offers "Spring Frame" smooth-riding comfort and safety, plus new streamlined beauty. National Defense may mean a wait for one of these great Indians, but your Indian dealer will gladly help you get more service out of your present machine.

ASK YOUR DEALER FOR THIS NEW FREE BOOKLET

Jam-packed with ideas to help you get more out of any make of motorcycle. Ask your local Indian dealer for a free copy, and Indian literature.



INDIAN MOTORCYCLE CO., SPRINGFIELD, MASS.

Billions Waiting to Be Taken

(Continued from page 53)

precaution to ensure the safety of the huge treasure—everything except getting it ashore.

The gold and silver had lain aboard the cornered galleons several weeks when the British, joined by a number of Dutch ships, cruised up and went into action. Their troops took by assault one of the key forts. Then the fleet sailed full tilt toward the harbor barricade. With half a gale driving them, the attackers smashed through.

Within 30 minutes the bay was lit by the glare of blazing galleons, fire ships and men-of-war. Exploding powder magazines flung burning brands across the scene. The British and Dutch tried to save the treasure, but the Spanish commander gave orders that those galleons not sunk should be set afire. Next day the British sent divers to attempt to salvage some of the treasure, but they brought up little of value. Many salvaging companies have been formed since to raise this vast treasure, but they have recovered only about \$20,000,000 in plate and specie. The \$120,000,000 in gold and silver in Vigo Bay is one of the biggest unfinished salvage jobs in the field.

In the 19th Century, the greatest loss was the destruction of the Turkish and Egyptian fleets by the European allies of Greece in the Battle of Navarino Bay, October 20, 1827. The commander of a Turkish frigate made the mistake of firing on the flagship of Admiral Sir Edward Cedrington, Commander-in-Chief of the allied fleets. Out of that shot grew one of the most costly fights in the annals of sea warfare. For 18 hours the air was filled with bursting shells and the rattle of musketry. Fire ships spread havoc among close-packed ships. When the Turks and Egyptians surrendered, the last great battle of wooden navies was done and \$90,000,000 in gold and silver lay on the bottom.

Then came the 20th Century, and its huge share of sunken ships. There have been no losses to compare with the argosies of former centuries. There is not the same flow of actual treasure, but two of the more interesting wrecks were the "Merida" and the "Hampshire."

The "Merida" went down off the Virginia Capes, May 12, 1911, carrying \$5,500,000 including the notorious "cursed" jewels of

the Hapsburgs. According to the story, the jewels were first filched from a Burma temple by Count Hans Hermann. He was caught stealing the gems by a native priest, and when he killed the priest a curse was laid upon the Hapsburg family as long as the jewels should remain in their possession. Count Hermann was the first to die a violent death, and madness, murder, exile and accidents have pursued the Hapsburg dynasty to this day. The jewels were given to Maximilian and Charlotte of Austria when they came to Mexico to build a new empire. Their story ended in a firing squad for Maximilian, madness for Charlotte. Finally the gems were stolen by Porfirio Diaz, who attempted to get his treasures, together with 14 tons of silver to Europe on the "Merida"; but it was rammed in a fog and the Hapsburg treasure is part of Davy Jones's magnificent collection.

The "Hampshire" carried \$9,260,000 and England's famous Lord Kitchener, who was enroute as special wartime ambassador to the Russian Czar in 1916. In the black night on the North Sea the "Hampshire" struck a mine and sank immediately.

More than \$3,000,000,000 is the value set on the treasure held by Davy Jones. What are the possibilities of its recovery?

Eighty percent! And this may be accomplished with the scientific deep-sea devices, queer robots developed during the last ten years. The day of the traditional diving dress has passed. The modern era of submarine treasure hunting began with the observation bell; then came the "iron man" robot, which resembles some strange creature from another planet and which has a depth limit of 1,500 feet; this was recently followed by the toggle-jointed diving-sphere robot with a proved depth range of approximately 5,000 feet.

Recent interest in gold as a result of its increase in value has directed attention toward the sunken caches where vast fortunes are waiting the hand bold enough to stretch down through the dark pressure-packed waters to bring them to light again. With the ultra-modern equipment now available treasure expeditions may become one of tomorrow's "big businesses." Some day you may set out to find the wealth that has been spilled in the Seven Seas. It is still there—waiting for someone to take it.

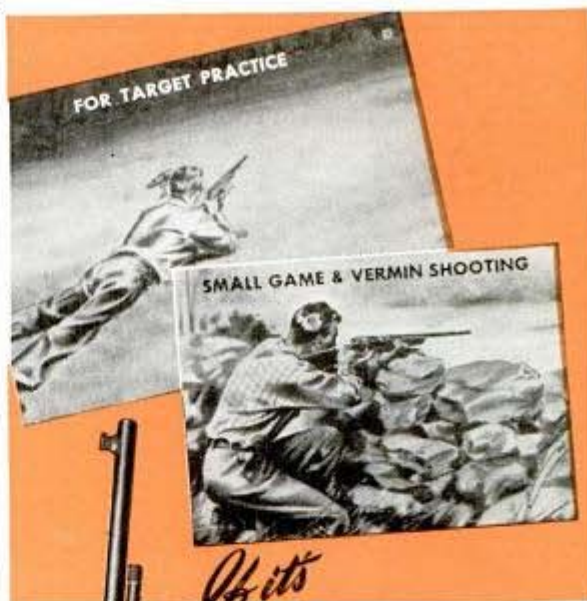

If it's
PERFORMANCE

**YOU WANT IN
A .22 RIFLE**

Accuracy is the foremost quality of a Savage .22 Rifle. Accuracy that's *outstanding* in the light rifle field. That's a matter of record—proved time and again through owners' experience, and comparative targeting tests. Second only to this most important feature is the *speed and dependability* of the rifle's action. No long interval, no shift in aim between release of the striker and firing. The bolt throw is short, smooth, and easy. You can demonstrate these features to your own satisfaction by operating the rifle at your dealer's before you buy. Finally, the man's size walnut stock is well proportioned. It enables you to hold steadily on your target and make the *most* of the rifle's accuracy.

Yes . . . if it's *Performance* you want in a .22 Rifle, you'll do *best* to select a Savage.

Model 3—Single Shot
Model 4—Clip Repeater
Model 5—Tubular Repeater (illus.)

SEND FOR FREE CATALOG

and current price list, on all
Savage Rifles and Shotguns.

Savage Arms Corporation
Dept. 2804, Utica, N.Y.

SAVAGE
.22 Rifles 



How You Can Help "KEEP 'EM FLYING!"

★

America needs TRAINED MEN — now! — to "keep 'em flying!" Get the MODERN, PRACTICAL TRAINING you need, at low cost, in spare time. Start at once to become an expert

**TOOLMAKER
INDUSTRIAL FOREMAN
AVIATION MECHANIC
SHEET METAL WORKER
AVIATION DRAFTSMAN**

or prepare for advancement in your present line of work. Turn to page 15A and mail the coupon right now!

Make BIG MONEY AT HOME! NEW Invention Electroplates by BRUSH



Now Plates CHROMIUM!

ALSO GOLD, SILVER, NICKEL, COPPER, ETC.
War Increases Demand—You Profit!

New, patented invention makes possible big earnings AT HOME. Replate auto-parts—worn articles in homes, stores, hotels, restaurants, etc.—with durable, sparkling, new coat of metal—with stroke of brush. Easy, simple, quick. Genuine Gold, Silver, Nickel, Cadmium, etc. Everything furnished. Outfit complete, ready for use. No shop required. Clear from \$2 to \$5 an hour in lifetime business. Small investment starts you in business. Steady repeat. Machine can pay for itself in week. Send TODAY for FREE SAMPLE and illustrated BOOKLET how you can have a life income from a business of YOUR OWN built upon satisfied customers. Act at once!

WARNER ELECTRIC COMPANY
215 W. Ohio St., Chicago, Ill., Dept. 108

FREE BOOK & SAMPLE

WARNER ELECTRIC CO., 215 W. Ohio St., Chicago, Ill., Dept. 108
Gentlemen: Send me Free Sample and Illustrated Booklet.

Name _____

Address _____

City _____

State _____

THE DELTA POWERlite

AMERICA'S FINEST ELECTRIC LANTERN

800 FEET OF
PIERCING SPOTLIGHT



Here's a powerful light for around camp or cottage—for night fishing. Big 6 1/2" front reflector shoots 800 ft. spot beam. Top reflector throws wide floodlight. Either at flip of the switch. Uses a 6-volt battery. Unbreakable lens. \$3.35 less battery at your dealers.
DELTA ELECTRIC CO.
300 W. 32nd St., Marion, Ind.

EXACT
SIZE

YOUR NAME HERE
NUMBERS AND STREET
CITY OR TOWN & STATE
PHONE, ROUTE, BOX, S.S. NO.

IDENTIFICATION
BRACELET \$1.99
Thick
STERLING SILVER
TAG
DEEP SUNK LETTERS!

Plated Chain and Clasp
Your Money back if not satisfied!
1076 SO. GRAND AVE.
IDENTI-TAG CO., LOS ANGELES, CALIF.

WITTE DIESELECTRIC PLANTS

Your present power bill will buy a WITTE that produces power and light for 1c a K.W.H. Save up to 75%. A Size for Every Need. Write today for finance plan, literature and name of dealer.



WITTE ENGINE WORKS, 1745 Oakland Ave., Kansas City, Mo.

FREE-FLUORESCENT

Wholesale Catalog and Sales Kit

BREATH TAKING new low prices that NOBODY else can match. LAMPS INCLUDED with every fixture. Sensational values; big profits. Advance commissions. Units for every use. Check all Fluorescent offers BUT DON'T MISS THIS ONE! The more you compare the better you'll like it. Write today. SURE.

PRICED
TO SELL
FAST!

CONSOLIDATED FLUORESCENT CO., INC.
216 W. NORTH BANK DRIVE, CHICAGO

OTTAWA Log Saw \$39



PUTS THIS OTTAWA to work for you. MAKE MONEY! Wood is valuable. Does more than 10 men. Easily operated. Falls trees—saws limbs. Use 5-hp. engine for other work. Write for FREE Book.
OTTAWA MFG. CO.
5527 Wood St., Ottawa, Kans.

MOTOR DRIVEN Flexible SHAFT TOOL at only



WITH PENCIL-SIZE HANDPIECE for "FINGER-TIP" CONTROL. Performs countless tasks quickly, efficiently, effortlessly. Use the FOREDOM on wood, metal, glass, plastics, etc. Provides easy accessibility, unobstructed view. Grinds, polishes, drills, mills, engraves, sharpens, slots, sands, carves, etc., etc. Complete Workshop—including 2 1/2 Hp. Accessory Set, \$16.15. Order your set today. FREE. new complete catalog.
Foredom Electric Co., Dept. 325, 27 Park Pl., N. Y.

\$14.95



8 Mile Range-Wide Vision
BINOCULARS \$4.75

15 Days FREE TRIAL
Postpaid or C. O. D.

Comes complete with case and straps. Well ground powerful lens. Specially focused for all distances and eye widths. Latest features. Ideal all-weather binoculars. Guaranteed. If not satisfied after 15 days trial, money refunded. AGENTS WANTED.
Vogue Binocular Co., 8420 S. Ashland, Dept. 608, Chicago

Say you saw it in Popular Mechanics!

POPULAR MECHANICS



"It's spring. He forgot to clean out his radiator with Sani-Flush"

This year, of all years, don't risk a clogged radiator that can lay up your car. When you remove anti-freeze, clean out dangerous rust and sediment. Sani-Flush does it scientifically. Costs only a few cents.

Don't take chances on just flushing with water. Sani-Flush is thorough. Use it yourself, or ask your service station. Tests have shown Sani-Flush harmless to any engine or fittings, when used according to directions on can. It's in most bathrooms for cleaning toilets. Sold in grocery, drug, hardware and 10c stores. The Hygienic Products Co., Canton, O.

Sani-Flush

CLEANS OUT RADIATORS

DOOR-EASE
STAINLESS STICK LUBRICANT

EASES STICKING WINDOWS

Use Door-Ease—like a crayon—for things that stick or squeak... windows, doors, drawers, latches and friction catches, zippers, screws, etc. Clean, weather-proof, long lasting!—Door-Ease Mfrs., Muskegon, Michigan.

10¢

in metallic container at Hardware, Auto Accessory, Dept., and Dime Stores.



MANUFACTURING OPPORTUNITIES



In essential materials used daily in tremendous volume by the building industry.

We equip you with special line production machinery—using local low-cost raw materials—only modest investment required—balance easy monthly payments. Scores of established manufacturers have proven the quality and salability of product, as well as the earning power and stability of this business. (Names on request.)

This opportunity offered only one man in each community to make this proven low-cost material. (Samples furnished.) Act now while your territory is still open. Write or wire for Free Books and learn how you too can own one of these profitable businesses.

W. E. DUNN MFG. CO.
600 W. 24th St., Holland, Mich.

SANDS 10 Times Faster...



New Guild PORTABLE
ELECTRIC Sander

Now, do better sanding this easy way—10 times faster! This sturdy, portable belt sander turns out expert work in minutes—instead of hours of hand-sanding drudgery.

Gives everything you make that expert finish. Works on wood, metal, stone, plastics. Sells at popular price—weighs only 9 pounds. Fully guaranteed. Try it at your hardware dealer's, or WRITE us today for full details.

SYRACUSE GUILD TOOL CO., 1742-5C No. Salina St., Syracuse, N. Y.

BIG MONEY BUILDING MEAD'S

NEW PORTABLE OUTBOARD BOAT



IN A FEW DAYS AT HOME!

Build this light 50 lb. tough, durable, seaworthy portable Outboard Ki-Yak! Take it anywhere by hand or car. Safe, dependable, trouble-free. More speed per horsepower, more miles per gallon. MEAD'S perfected metal-ribbed, cut-to-fit construction Kit guarantees successful assembly quickly, easily, economically. New 69 lb. OK-4 uses oars, sail, motors, 9 h. p. or less. Also 3 "CK" paddle—sail models from 20 lbs. to 45 lbs. Double Paddle or Oars INCLUDED with your Ki-Yak! Write for FREE lavishly-illustrated circulars, low Factory-To-You Prices!

MEAD GLIDERS, 15 S. Market St., Dept. B-52
CHICAGO, U. S. A.

How to make your workshop pay dividends



Learn how you can build up a profitable spare or full-time business in your own home. This new book "How to Make Money in Woodworking" is crammed with practical tested ideas, plans, and suggestions. Tells you exactly what to make, how to make it and how to sell it. Describes plans that have worked for others. Woodworking, the new way, is light, pleasant, and profitable. Send only 10¢ and complete book will be mailed postpaid. Satisfaction guaranteed or money refunded. Write to The Delta Mfg. Co. (Dept. 681-E) 600 E. Vienna Ave., Milwaukee

local reception is best received between 1600 to 1300 kc., an adjustable 3-30 mmfd. trimmer condenser will provide better tuning. On the other hand, if reception is best from 600 to 550 kc. a 100-mmfd. fixed condenser will increase volume and sharpen

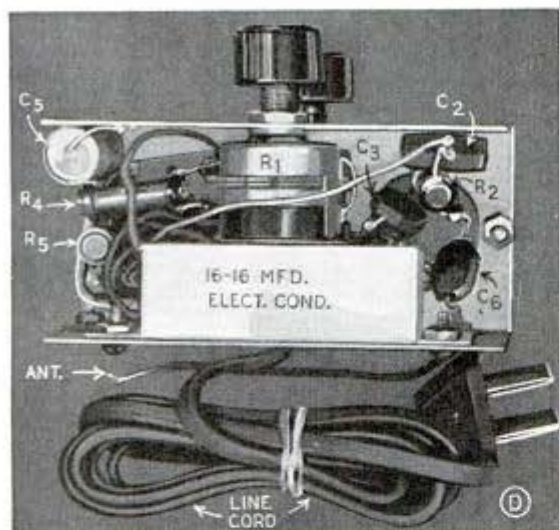

tuning. Although designed for headphones, this unusual one-tube set will operate a small speaker with good volume on local stations. The blueprint number for this article is R-303.

All-Wave 3-Circuit Tuner

(Continued from page 158)

shown in Fig. 2 and space the coils $\frac{1}{8}$ in. apart. Bring out the secondary taps at the designated number of turns by taking a twist of the wire around a match stick. Drill the finish holes upon completing each winding and leave sufficient wire to reach the terminal panel lugs.

Cut the terminal panel from a piece of heavy cardboard and mount the 6 large-hole soldering lugs by means of short machine screws and hex nuts. Final assembly is then made as shown in Fig. 3 using $\frac{1}{4}$ -in. 20-thread hex nuts, panel bushing and washers to mount the tickler coil shaft.

Cement or glue the cardboard terminal panel to the large coil form at rear, paint the windings with coil dope and solder the various coil leads to the terminal board lugs indicated. You are now ready to check with the coil diagram (C), after which the tuner is ready for mounting in your new receiver by means of the panel bushing. A tuning knob at the front of the set panel completes the assembly.

FREE RADIO CATALOG!

KEEP 'EM LISTENING!



Send for this FREE Spring and Summer Catalog that shows Everything in Radio vital for our home front, our war production and our armed forces. More than 40 new Radio models; Sound Systems; Builders' Kits; radio instruction equipment; 15,000 parts for every radio need—all at lowest prices!





EVERYTHING IN RADIO AT LOWEST PRICES!

See the new 1942 table model sets, portables, phono-radios, etc.; new Communication sets; 7-60 watt Sound Systems; Builders' Kits; supplies for radio training; tubes, tools, books—everything in Radio to keep 'em listening, keep 'em learning, keep 'em producing!

LEARN RADIO!

Radio Builders' Handbook. Radio fundamentals for beginners. Invaluable. Only

10c

Radio Dictionary. Complete, authoritative. Everyone in radio needs it. Only.....

10c

ALLIED RADIO

833 W. Jackson Blvd., Dept. 5-E-2
Chicago, Illinois

Free

Rush me your FREE New Catalog.
 Enclosed is 10c for Builders' Handbook.
 Enclosed is 10c for Radio Dictionary.

Name.....
Address.....

SEND FOR IT NOW!

Take your Ta-pat-co SLEEPING BAG

BLAZE NEW TRAILS TO THE LAND OF YOUR DREAMS



G

Go out where the trout fight a little harder, up where the days stretch a little longer—that's where the rest begins. With your Ta-pat-co sleeping bag you have sleeping comfort with you. At the close of the day when happily tired muscles welcome a well-earned rest, you spread your Ta-pat-co under the roof of the star-studded sky and there, hovered by the outspread wings of giant trees, you sleep. Go to your sporting goods dealer—add a Ta-pat-co to your sports equipment now.



THE AMERICAN PAD & TEXTILE CO.
Dept. 50 Greenfield, Ohio

THE OUTDOOR BED

Ta-pat-co

FOR THE OUTDOOR MAN

How to call wild ducks without a call—weigh fish without scales—pick up wild rabbits—and 100 other DO'S and DON'TS for your safety, pleasure and comfort on outdoor trips. Write for your FREE copy Today!

Western Super-X

LONG RANGE **22's**

*Faster than
a Screeching
Dive Bomber!*

Super-X high speed .22's give pests and small game less chance to move before your bullet hits, than slower ammunition. The Super-X .22 L. R. streaks from your gun muzzle at 1385 feet per second! That's more than 15 miles per minute—more than 900 miles an hour! Mail the coupon below for free leaflet describing Super-X and Xpert .22's, and the handy, helpful 76-page Western Ammunition Handbook.

**1385 FEET
PER SECOND**

WESTERN CARTRIDGE COMPANY,
Dept. E-46 East Alton, Ill.
Mail FREE leaflet on SUPER-X and XPERT
.22 cartridges, and the new, revised edition of
the valuable Western Ammunition Handbook.

Name _____

Address _____

Post Office _____

State _____

Substitutes We'll Keep

(Continued from page 4)

21415

A permanent change in the construction of screw bases for electric lamps is seen in the substitution of brass-plated steel for solid brass. Engineers say the substitute is less expensive and appears to be just as good. For wires that lead from the lamp base to the filament inside the bulb, nickel-plated steel has taken the place of solid nickel.

Strategic metals also play a part in the manufacture of porcelain—the material used for electrical insulation of power lines and in electric switches and transformers. Porcelain is made by molding a mixture of special clays into desired shapes, coating them with a glaze and baking at high temperatures in a kiln. This glaze, which appears as a hard, glasslike coating on the finished product, is applied as a watery mixture of many materials, including compounds of nickel, zinc and other metals. Engineers at Westinghouse started a search for a glaze without these strategic materials. When they succeeded a few months ago, they found they had a substance superior in many ways to the old. The new glaze increased the strength of porcelain 100 percent, producing a better insulator and one easier to manufacture and more resistant to weather.

Our research chemists have been working on an idea for an entirely new type of plastic. The material originally was intended for use in making parts of household appliances, to do away with sheet steel and thick walls of insulating materials. But because this same plastic promises to be useful to the United States Army, the research work has been pushed faster than planned, with good results.

So far plastics have been of two general types. One is the molded type which can be poured or pressed into molds to form such odd shapes as ash trays, fountain pens and small radio cabinets. But this type lacks the strength needed in some applications. The other type is known as laminated plastic. It is made by piling up layers of paper, cloth or other sheet material, impregnating them with resin and then hardening the resin under pressure and heat. This type has strength—sometimes equaling that of steel, weight for weight—but it is impossible to form it into

21415

complex shapes with sharp corners and other irregularities.

The new Westinghouse plastic is understood to combine the advantages of these two types. It is called a preformed plastic, because a mixture of wet pulp and resin is first formed in the general shape of the finished product. Then the piece is baked under pressure to harden the resin. The preformed plastic has the strength of the laminated plastic and the moldability of the molded type.

Our chemists are now working out methods to use this preformed plastic in several military items. One example is in the windshields, or streamline noses, of anti-tank shells which are now made of aluminum. These windshields must be lightweight to maintain balance of the shell, yet strong enough to prevent their flying apart as the shell whirls through the air at tens of thousands of revolutions per minute. Another suggested use for the new plastic is in a new, two-part army helmet. The inner part of this helmet is to be made of preformed plastic, which is strong but lightweight. This part could be worn by the soldier during ordinary field operations. During battle, the other part, made of steel, could be slipped on over the plastic part to give greater protection.

In another unusual development, porcelain is being used as a substitute for phenolic plastics. Phenolic plastics are compounded primarily from formaldehyde, phenols and cresols, all of which are in demand by our armed forces. Porcelain is being substituted satisfactorily; in many applications it has proved better than plastics. It lends itself to the manufacture of parts for ignition systems, thermostats for industrial furnaces and even stoppers for perfume bottles. Water-cooler parts formerly made of aluminum are being produced from this same type of porcelain, which also finds use as a substitute for hard rubber in making valve seats.

From these few examples, we can see that the war is bringing about the development of new products and processes that may prove better than any we ever had before.

Write to the firms listed in the Where-to-Buy-It index, to learn more about products described in this magazine. Say You Saw It in Popular Mechanics.



Make Out of Waste Materials!

Here is a wonderful new idea for home craftsmen . . . plans for Kleenex Tissue Dispensers that can be made in one evening.

There are hundreds of uses for Kleenex around the home—many keep a package in every room—so why not dress them up and make them an attractive addition to interior decoration in your home?

Twelve working plans for Tissue Dispensers which features simple joinery with hand tools and double-duty designs in plywood, plastic and metal construction are available to all home craftsmen now.

SEND FOR PLANS TODAY!

Plans are complete with accurately scaled drawings, detailed instructions, material list, construction notes and decoration guides. Just mail the coupon below along with 10c in coin or stamps to cover the cost of handling and mailing to: Kleenex Project Service, Dept. PR-5, 919 N. Michigan Ave., Chicago.

KLEENEX PROJECT SERVICE CRAFTSMAN PORTFOLIO

Every Home Craftsman will want this new Portfolio. The 12 plans included were proposed by expert craftsmen . . . approved by Industrial Arts Instructors everywhere.



12 PLANS FOR 10c MAIL TODAY!

Kleenex Project Service, Dept. PR-5
919 North Michigan Avenue, Chicago

Please send me Craftsman Portfolio. (Enclosed 10c)

Name

Address

City..... State.....

NEW HEARING AID

gives users

new confidence



This new Western Electric vacuum tube Audiphone, by the makers of Bell Telephones, is helping thousands to *hear clearly*, to live fully, to face the future with renewed energy and courage. They praise its vibrant, natural tone—find it enables them to understand speech better even in noisy places. Try the Audiphone—hear for yourself how much it can help you. Send the coupon today!

Western Electric AUDIPHONES

by the makers of BELL TELEPHONES

GRAYBAR ELECTRIC COMPANY PM67
Graybar Building, New York, N. Y.
Please send booklet "Your Key to Hearing Happiness" and name of nearest Audiphone dealer.

Name _____
Address _____
City _____ State _____

FREE WARD'S '42 PHOTO BOOK will save YOU money!

12 Hints TO BETTER COLOR PHOTOS Included

Low Prices for Terms or Cash

Ward's prices are "rock bottom" on every fine camera (still or movie) catalogued—most merchandise is shipped **Postpaid**. You also can save money on all other equipment: film, paper, chemicals, etc. **No carrying charge** on many items. Every purchase made at Ward's is guaranteed to satisfy. *Send for Camera Catalog without delay—today.*

Write Now
MONTGOMERY WARD Dept. PM-542 CHICAGO, ILL.



Make Your Own STATIONARY POWER UNIT!

Any automobile or truck engine equipped with a Pierce Flyball Governor will make you a dependable and economical power unit for operating—machine shop equipment, welders, air compressors, feed grinders, hoists, etc.

Pierce Governors give you controlled engine power—adjusting instantly to any change in load and maintaining constant engine speed. Belt-driven, V or Flat. Easily installed and never equalled for close regulation and long service.

Write for prices and literature telling how to build power unit, stating make and model of engine to be used.

THE PIERCE GOVERNOR COMPANY
1653 Ohio Avenue, Anderson, Indiana



EASY TO READ—easy to clean, unconditionally guaranteed for one year. The crack-proof *white* surface is bonded to the steel—protects it from rust. 25, 50, 75, 100 ft. lengths. Sold by hardware, building material, mill supply dealers everywhere. Write for folder. **KEUFFEL & ESSER CO.**, Hoboken, N. J.

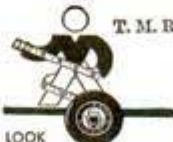

LOOK FOR THIS DISPLAY

T. M. Reg. U. S. Pat. Off.



K&E WYTEFACE STEEL MEASURING TAPES

Don't Waste Miles



Lost directions often cause miles of wasted travel and delay. Motorists everywhere are depending upon the Hull Streamline Auto Compass to keep them on the right road. Write for Name of Nearest Dealer

HULL MFG. CO., P. O. Box 246-D5, WARREN, OHIO

★ WEAPONS OF WAR for Today's ★

BOLENS "SOLDIERS of the SOIL"

HUSKI

Help Make America the "World's Bread Basket"

Write for Catalog
BOLENS PRODUCTS CO.
Dept. PM-4
Port Washington, Wis.



GARDEN TRACTORS . . .

ANYONE CAN DO THIS IF THEY HAVE OUR CHART

Blue Print 27"x36" shows how to find length of any rafter, find any angle in degrees, frame 3 to 16 sides, read board foot and brace tables, octagon scale, rafter tables and much other information. Can be scaled down for model work as well as full scale framing. Also Chart changing pitches to degrees for use with Radial Saws. Send 50c coin. No stamps. **MASON AND PARRISH, ENGINEERS**, 2103-C North Burdick St., Kalamazoo, Mich.

SCREW-IN PLUG New FLUORESCENT



Screws Into Socket Like Ordinary Bulb

PRICES as low as \$3.55 including Tube—No "installation" or special wiring—screw in and light; these LITE-RING fixtures now open up fabulous sales to stores, offices, factories, homes—of sensational genuine FLUORESCENT Lighting. Three Times the Light—Like daylight. Saves its own cost in current used. Rush name for facts. All free. **NAMCO**, Dept. 65, 433 E. Erie St., Chicago, Ill.

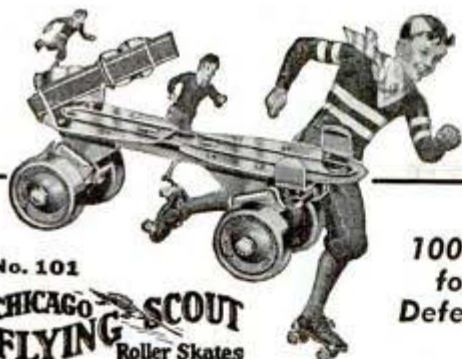

No. 101

CHICAGO FLYING SCOUT
Roller Skates

100%
for
Defense

The AMERICAN Way

"CHICAGO" Roller Skates are now serving our boys in many camps—helping to "KEEP AMERICA FIT". If they are hard to get, it's because Uncle Sam needs the materials to win the fight. While fighting for our Country—our Freedom—our homes and lives, let us support our government's defense program 100%—it's the AMERICAN Way.

Sidewalk—Rink—Dancing—Trick
and Professional Roller Skates

CHICAGO ROLLER SKATE CO.

Winner of WORLD'S Records for over 40 years
4414 WEST LAKE STREET CHICAGO, ILLINOIS

BUILD YOUR GRANDFATHER CLOCK

Send 35c for Simple SHOP TESTED COPYRIGHTED BLUEPRINT. The Simple Sensible Rod-&Kut way as thousands have, DIME brings PLANS and sixty picture "HOW" Book pricing many fine brass weight Westminster, tube chime, electric and battery movements showing nine beautiful colonial grandfather cases. Build now and save half. KUEMPEL CHIME CLOCK CO., Bldg. 64, Guttenberg, Iowa.



Raise Your Income \$25 a Week!

No Experience Needed

Make Big Money In Spare Time With
Ideal Lawnmower Sharpener

FREE PLANS SHOW YOU HOW TO BUILD A PROFITABLE BUSINESS OF YOUR OWN

There's big money in sharpening lawnmowers with the Ideal Sharpener. Most men earn up to \$25 a week... even in spare time. Howard Heller, Minn., grossed \$1,100 from April 15 to Sept. 15. No experience needed. It's easy. Just set mower in the Ideal, make a few simple adjustments... the machine does the rest. Ideal sharpens like magic... makes old, dull, worn blades cut like new. You get \$1.00 to \$1.50 for every job. Our FREE Plans show you how to get plenty of orders. Start in basement or garage. Work spare or full time. Easily, quickly, you build up a money-making business of your own. Today, when people have money, is a good time to start.



SIMPLE. FAST. EASY TO OPERATE. GRINDS MOWERS TO KEEN CUTTING EDGE IN ONLY 15 TO 20 MINUTES

THE FATE-ROOT-HEATH COMPANY
1542 BELL STREET - PLYMOUTH, OHIO

SEND FOR FREE 24 PAGE BOOK



How Atlas SERVES THE NATION

Off. U. S. Navy Photos

U. S. S. Philadelphia



U. S. S. Savannah

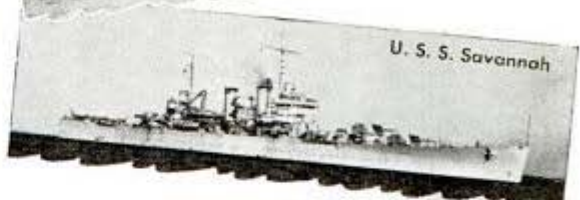

U. S. S. Gudgeon



CRAMP SHIPBUILDING COMPANY

SETS VICTORY TEMPO



Atlas Milling Machine—part of the Cramp emergency plant equipment.

Ships, ships—and still more ships! That's America's victory cry in the battle of the supply lines.

Valiantly doing their part—crowding every last ounce of effort in the race against time—is the Cramp Shipbuilding Company, Philadelphia, one of the oldest (1830) and best-known names in American shipbuilding. Soon new warriors of the sea like those above will slide down Cramp's ways to join the battle wagons of the fleet.

Atlas is well represented among Cramp's busy machine tools, as it is in the major war production plants in the nation.



ATLAS PRESS CO.

543 NORTH PITCHER STREET
KALAMAZOO, MICH.

LATHES - DRILL PRESSES - SHAPERS
ARBOR PRESSES - MILLING MACHINES

Say you saw it in Popular Mechanics!



KRW ARBOR PRESSES BENCH TYPE AND HYDRAULIC

NEEDED IN EVERY SHOP—SAVE TIME AND MONEY—DO BETTER WORK, QUICKER.

No shop is complete without a small arbor press. Pressing and squeezing operations can be done better and faster on a KRW Arbor Press. Stop using vise and sledge hammer methods—they generally deliver spoiled work in the end. KRW Factory-To-You Prices give you greater value for your money. Order today.

KRW Bench Type Arbor Presses, 3 sizes

No. 37-P 1/2 Ton, \$13.25*
 No. 37-O 1 Ton, \$23.00*
 No. 37-N 3 Ton, \$33.00*
 *Prices F.O.B. Arcadio, N. Y.
 Slightly higher west of Rockies.
 Stand illustrated extra.



KRW Hydraulic Presses are built in 25, 50 and 75 ton sizes. Prices start at \$198.00*



K. R. WILSON 17 Lock St., BUFFALO, N. Y.
 Builders of Shop Equipment for Ford Dealers Since 1916

BETTER, QUICKER WORK WITH LESS EYESTRAIN

MASTER BRITE-BLADE is the only 6' steel tape rule with black markings on a pure white surface. It's easier to read in any light. Special white surface is acid-proof, crack-proof, smooth and hard.

Flat-edge unbreakable metal case with push-button lock (optional) gets and holds inside and outside measurements quickly, accurately—a one-hand job. Case comes apart for cleaning or inserting spare blade, an exclusive MASTER feature that doubles service life!

Measuring is faster, more accurate and easier on the eyes with MASTER BRITE-BLADE. At hardware stores and mill supply houses or direct from factory.

MASTER WOOD AND TAPE RULES

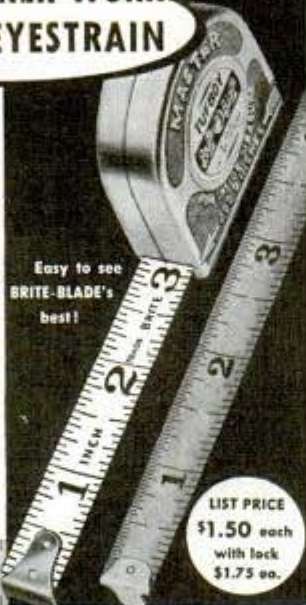

LIST PRICE
 \$1.50 each
 with lock
 \$1.75 ea.

CLIP AND MAIL COUPON TODAY

Master Rule Mfg. Co., Inc., Dept. F 5, 815 E. 136th St., N. Y. C.
 Please send me _____ BRITE-BLADE RULE (\$1.50). _____ Spare blade (65c). _____ BRITE-BLADE RULE with lock (\$1.75). I enclose _____

Name _____
 Address _____ City & State _____

(5) 2344

PAINT BRUSHES SCARCE! Keep NEW brushes soft RENEW old brushes

Conserve valuable paint brushes. Save them by using DIC-A-DOO PAINT BRUSH BATH after every use. Amazingly efficient in loosening, washing away paint from bristles. Brush remains good as new for long time. Restores old hardened brushes to usefulness. Costs only 5 cents—enough to clean several brushes. Get it at hardware or 5-&-10c stores. You'll want to keep several packages on hand.

THE PATENT CEREALS CO.
 makers of Dic-A-Doo Paint Cleaner
 GENEVA, N. Y.



★ SAVE YOUR TIRES! ★

AUTOMATIC TIRE COP! Yells for help when thieves go at your car. Screwdriver installs in 15 minutes on any car. Protects all tires, accessories, gas, car itself. Send no money. Pay postman \$1.50 (Special Sample Price) plus few cents postage on delivery. Use 5 days. Money back if not satisfied.
TIRE COP CO., Dept. B-10, Madeira, Ohio



PHOTO ENLARGEMENTS

Is Photography your hobby? Do you want a profitable easy business at home? Make **PHOTO ENLARGEMENTS** for yourself and others. Your cost 5c each and less. The Ideal Photo Enlarger is **AUTOMATIC**. No experience required. Also **COPIES** any picture \$7.94 COMPLETE. Interesting literature **FREE**.

5¢ ANY SIZE

Ideal-O, 148 West 23rd St., New York City

GREAT NEW

FLASHLIGHT IDEA

GIVES FREE USE OF BOTH HANDS!



Rex Ristlite snaps on like a wristwatch! Throws 500 ft. beam. A boon to mechanics, car owners, sportsmen, housewives, Army, Navy men! G-E pre-focused

bulb. Light, colorful plastic. 98¢ — wherever flashlights are sold.

FLASHLIGHT COMPANY OF AMERICA
 Dept. M, Jersey City, N. J.

98¢ with Batteries

REX **Ristlite**



ALSO STANDS ALONE at any angle

POPULAR MECHANICS

STOP DRIPPING



NO DRIP

No More Damage from Condensation or Sweating Pipes, Tanks, Walls, Ceilings and Air Ducts

Insulates and adds years of life to pipes and other metal surfaces by preventing rust and corrosion. Easy to apply with a brush, trowel or spray. Stucco-like finish. Can be painted any color.

A gallon covers 30 feet of 1" pipe. Get at Hardware, Plumbing, Mill Supply Dealers or direct. **Circular free.** Write today.

J. W. MORTELL CO.
522 Burch St. Kankakee, Ill.



NO DRIP—A sensational new plastic cork coating prevents condensation drip from metal, concrete, brick, wood, composition, plaster.



WITH AN EVINRUDE, nearby lakes and streams become happy vacation spots, with endless opportunities for fishing, boating, recreation. Visit your Evinrude dealer... his store is "headquarters" for outboard motors and boating needs. Many now offer excellent values in reconditioned motors. Consult your classified phone directory under "Outboard Motors". 1942 catalog free — address, **EVINRUDE MOTORS, 4906 N. 27th St., Milwaukee, Wisconsin.**



EVINRUDE OUTBOARD MOTORS



Use the *Chicago of Artists' Supply*
COLOR HELM
FOR EXPERT COLOR CONTROL

72 Spectrum Colors, 13,824 color combinations, fall into place automatically. Adjoining colors, Alternates, Triads, Complementarys. Complete unit—no parts to fit or lose. Price \$2.50 Postpaid. Also 36 color size, 1,728 color combinations. **\$1.**

FIATTELLE, INC., RIDGEWOOD, NEW JERSEY

All designs patented

TRUE TEMPER'S 4 Aces

• Feel the perfect dynamic balance of these 4 True Temper Tools—the force of their power-centered weight. Grasp the select white hickory handles—they are custom fitted to your hand. Examine the lustrous, satin smooth, rustless black finish—the most durable and attractive ever placed on hand tools. Listen to the ring of the perfectly tempered steel. You will vote them America's most efficient, useful and beau-

tiful hand tools—the urge to own them, use them and show them to your craftsmen friends will be irresistible.

Buy True Temper's 4 Aces at your home hardware store. If not in stock, mailed direct postpaid on receipt of list price quoted for each tool wanted. Produced only by the Makers of True Temper Products.

Prices slightly higher west of Denver.



Ace of Hammers
True Temper
Super Dynamic
\$1.50 each

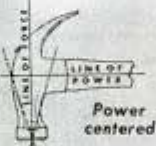

Power centered



Ace of Hatchets
True Temper
Dynamic
\$1.75 each



Ace of Heavy Hatchets
True Temper
Tommy Axe
\$2.00 each



Ace of Belt Axes—
True Temper
Tomahawk
\$1.75 each

To the Makers of True Temper Products
1941 Keith Bldg., Cleveland, Ohio

Please send me postpaid True Temper Super Dynamic Hammer Tommy Axe Tomahawk Dynamic Hatchet. Check those desired. Total enclosed \$

Name _____
Street _____
City _____ State _____

TRUE TEMPER PRODUCTS

FORKS • RAKES • HOES • SHOVELS
AXES • HATCHETS • HAMMERS • SCYTHES
FISHING RODS AND BAITS • GOLF SHAFTS

★ "YANKEE" ★ still makes tools for ★ YOU! ★

If you haven't been able to buy the "Yankee" Fine Mechanics' Tools you want—the spiral-ratchet screw drivers, the ratchet drills, the braces, vises, and tap wrenches—it's because they are working shoulder-to-shoulder with industrial America at the tremendous job of building ships, planes, tanks, and guns. Thus, whether you can buy them or not, they are at work for YOU! They're performing the time- and labor-saving service which they are so singularly and ingeniously built to do. They are helping to speed production so vital to Victory, and their reputation for dependability is growing every day.



No. 130A "Yankee"
Spiral Ratchet
Screw Driver

"YANKEE" TOOLS make good mechanics better North Bros. Mfg. Co., Phila., U. S. A. Established 1880

Makers, also, of "Yankee-Handyman" Household Tools

HOW TO CUT METAL EASIER, QUICKER

20-page shop manual. Valuable kinks on selection, use, care of hand and power hack saws, band saws. Complete selection tables. Only 5c at hardware stores.

ONLY 10c
postpaid
MAIL COUPON



CLEMONS BROS., INC., MIDDLETOWN, N.Y., Dept. AM
Enclosed find 10c for which mail postpaid one copy "Metal Cutting" booklet to:

Name _____
Address _____
City _____ State _____

Makers of STAR hand, power Hack Saw Blades, Frames, metal cutting Band Saws, Clemons D-17 Precision Lathe Machine.

WORLD'S LOWEST PRICED ADDING MACHINE

IDEAL FOR BUSINESS OR PERSONAL USE GUARANTEED ACCURATE. Not a toy. Operates with only a finger flick. Adds, subtracts, multiplies, divides. Counts up to ten million. Pays for itself over and over. Ideal gift for Business, Income Tax and School use. MONEY BACK GUARANTEE. Send name and address. Pay postman only \$2.50 plus postage. (Send full cash if outside U. S.) Money back in 10 days if not delighted. AGENTS WRITE.

CALCULATOR MACHINE COMPANY (Mrs.)
DEPT. 129 P. O. BOX 1118 CHICAGO, ILLINOIS



190

Is Your Tool Box Complete?

Does your tool box hold spacers in assorted thicknesses? Just the thing for quick set-up of milling machine cutters and other accurate spacing requirements. De-Sta-Co metal spacers can be used over and over. Send \$1.00 for "Trial Assortment" package, enough for average use. When ordering give arbor size wanted.

Get **DE-STA-CO** \$1.00
ARBOR SPACERS Trial Package

DETROIT STAMPING CO.
Established Over 25 Years
300 Midland Ave. • Detroit, Mich.

PRESENTING the New DAISY

DEFENDER

1000-SHOT MILITARY MODEL

Get the new Daisy Defender featuring Military Gun Sling, Bolt-Action Safety, Elevation-Windage Rear Sight. Looks like real Army gun. \$5 at Dealers or from us postpaid. Free Daisy Catalog, Boy's Arms Manual FREE. Write! (Duty added in Canada).

DAISY AIR RIFLES

DAISY MANUFACTURING COMPANY, 545 UNION ST., DEPT. 2, FLYMOUTH, MICH., U. S. A.

Must KEEP 'EM EATING!

while Flying, Rolling and Sailing On To Victory! It's total war! Every American has his task! On account of defense work, prompt deliveries cannot be made on all Models of SHAW Tractors; so please order early. We have repairs for all SHAW garden tractors and engines sold in our 39 years in business. Write us for your needs.

SHAW MFG. CO., 4505 Front St., Gallesburg, Kansas;
668-G No. 4th St., Columbus, O.; 5812-G Magnolia Av., Chicago, Ill.

SHAW and Peppy Pal "DU-ALL" GARDEN TRACTORS

BIGGEST \$100 PLANE IN U.S. GIANT 7-ft. GLIDER

Easily built, beautiful

COMPLETE Kit only \$100

CLEVELAND CONDOR

Soars for hours.

- 48" Eaglet (Baby Bowler type) Glider only 50c.
- At your dealer, or direct, Catalog of "America's FIRST LINE of Model Airplanes"—all Cleveland Gas, Rubber-powered, Stick and Glider Models, 5c.

On orders less than \$1.00 add 15c for packing and postage.

CLEVELAND MODEL & SUPPLY CO. INC., 4508B45 Lorain Ave., Cleveland, Ohio

FREE! HOW TO MODERNIZE WITH LOW COST POWER TOOLS

also SAWS • JOINTERS • LATHES • BAND SAWS

WRITE FOR NEW 1942 COMPLETE CATALOG

BOICE-CRANE CO. DEPT. 352 TOLEDO, OHIO

Say you saw it in Popular Mechanics!
POPULAR MECHANICS

A 2 OZ. HEARING AID BRINGS BACK A WORLD OF SOUND



**MAICO
"ACE"**

Transmitter Only
Weighs 2 Ozs.

Small as a pocket watch—yet enables a hard of hearing person to carry on normal conversation at twenty feet. Product of the Maico Company, Inc., which provides 90% of America's precision hearing test instruments, choice of America's armies and navies, ear physicians, airlines, etc.
FREE OFFER—You may give some hard of hearing friend, relative or acquaintance a happy day of good hearing—without cost or obligation. Send name and address of hard of hearing person to: **THE MAICO COMPANY, INC., Dept. 10B, 2632 Nicollet Avenue, Minneapolis, Minnesota.**

Don't throw away old paint brushes



Make them like new with Cabot's Brush Cleaner

Good bristle brushes are now expensive—hard to get. Cabot's Brush Cleaner will clean your old hardened brushes right down to the heel. Just rinse with water. Harmless. Non-inflammable. Non-caustic. Does not evaporate. Will save you many dollars in brush costs. **SEND ONLY 25c.** If your dealer does not yet carry Cabot's Brush Cleaner, send 25c for ¼ pt. Please mention dealer's name.



Samuel Cabot, Inc., 1241 Oliver Building, Boston, Mass.

CABOT'S BRUSH CLEANER

RE-STRING RACKETS AT HOME—EARN MONEY

EASY—PLEASANT—PROFITABLE
FREE WHITE FOR 1942 CATALOG AND INSTRUCTION SHEET NOW

W. A. Bickel & Co., 137 N. Marron, Dept. A-52, Oak Park, Ill.

BIG OPPORTUNITY Stucco Spraying



Present day construction needs better and faster finishing methods. Plastic COLORCRETE is waterproofed. It can be used on new or old buildings. It fuses with any masonry surface. Fills cracks and checks. Can be applied in any thickness and in 30 beautiful colors and shades.

Fully proven by over 14 years actual use under all climatic conditions. Offers big earnings. With this machine you can supply the big waiting market at amazingly low cost. Present operators report costs of 2c and up per sq. ft. and sell up to 7c. Some have paid for their equipment from first few jobs. Machine capacity up to 1,000 sq. ft. per hour.

Get the facts. Send for free book "Proven Business Opportunity." Write today.

COLORCRETE INDUSTRIES, INC.
570 Ottawa Ave., Holland, Mich.

Wood workers: Here it is!

only **10c**

Harold Hunt's big No. 14 wood catalog! Latest **UP-TO-DATE IDEAS** for experts and amateurs; **SPECIAL BARGAINS** in rare woods, veneers, and ALL kinds of supplies. 148 pages—20 of rare woods in color. Get posted! Send only 10c to **CRAFTSMAN WOOD SERVICE CO., 2729 S. Mary St., Dept. A-21, Chicago, Ill.**

Always write your name and full address clearly when answering advertisements.

WARNING!

The best years of your life are slipping by! Get **SOUND, PRACTICAL TRAINING** now, at low cost, in your spare time—be a **TRAINED MAN** the rest of your life! Start at once to become an expert

**MACHINIST
RADIO TECHNICIAN
DRAFTSMAN
SHIPBUILDER
ELECTRICIAN**

or prepare for advancement in your present line of work. Turn to page 42A and mail the coupon right now! "It is later than you think!"

FILING SAWS FOR VICTORY

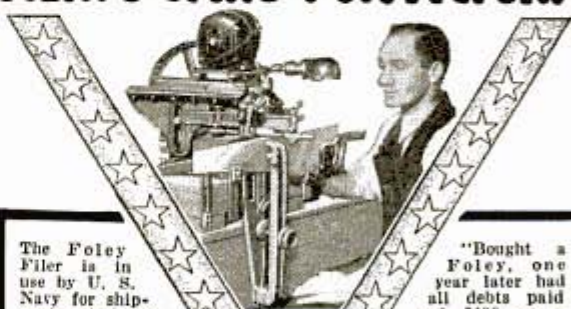

The Foley Filer is in use by U. S. Navy for shipyards, air bases, battleships, navy tenders—by U. S. Army posts and airports—by U. S. Engineers, Light House Dept., N.Y.A., W.P.A.—also hundreds of Defense and Mfg. plants.

"Bought a Foley, one year later had all debts paid and \$100 on a new home. Many days I earn as much as \$16."—J. H. Kellogg. Louis P. Wadwick says: "I have filed 764 saws in spare time."

MAKE A GOOD LIVING WITH FOLEY AUTO SAW FILER

The Foley files hand, band and circular saws better than the best hand filer. You can do expert work easily, quickly, without eyestrain. Patented jointing principle brings uneven teeth back to uniform size. **FREE PLAN** shows you how to start your own cash business in spare time—no canvassing. Send coupon now, —no salesman will call.

Paste coupon on postcard

Mail Coupon for FREE PLAN

FOLEY MFG. CO. 516-2 Foley Bldg., Minneapolis, Minn.

Send Free Plan on Saw Filing business—no obligation.

NAME.....
ADDRESS.....





NAVY "E"

Awarded to

SOUTH BEND LATHE

The Navy Ordnance Flag and "E" Pennant have been awarded to the South Bend Lathe Works for outstanding performance in the production of ordnance matériel for the U. S. Navy.

For years South Bend Lathes have served our Navy. More recently—since Defense demands have called for vastly increased machine tool production—South Bend has been "ahead of schedule" in the production of lathes.

Permission to fly the Navy "E" Pennant and to wear the "E" on our lapels, is an honor. These emblems serve as recognition for work well done—and as a reminder of the tremendous job that lies ahead. We will do our part to help finish it.

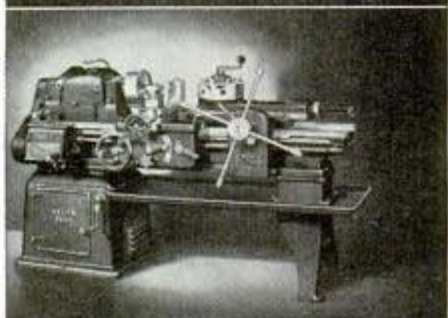
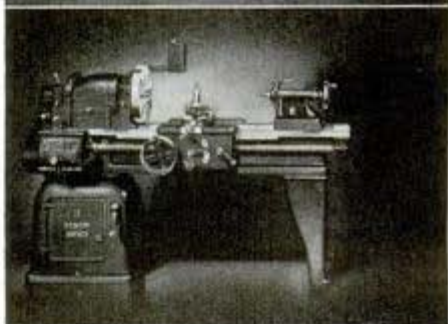
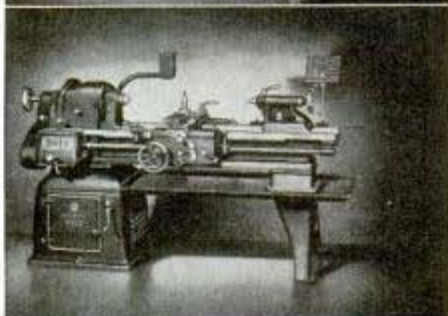
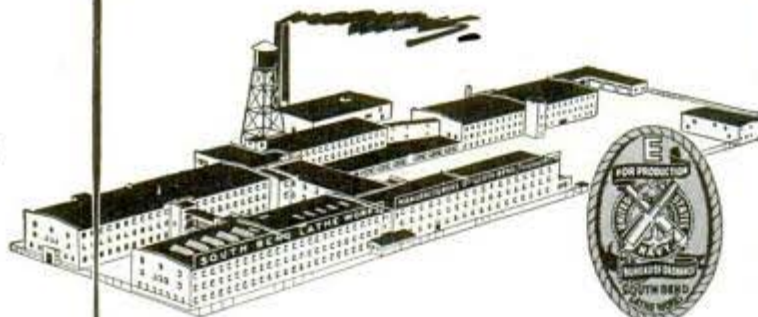

SOUTH BEND LATHE WORKS

617 E. Madison St., South Bend, Ind.

Lathe Builders for 35 Years

NOW.. a DYNAMIC HEAVY DUTY INDUSTRIAL WELDER

THE BOOM IS ON IN WELDING— EARNINGS ARE SKYROCKETING

WORKS OFF 110 VOLT ELECTRIC LIGHT CIRCUIT



Thousands of welders have already left their jobs and shops to get "war-time" pay in plants devoted to defense production, such as ship building, tanks, airplanes, munitions, etc. Also, in the erection of industrial plants, bridge construction work, etc. This creates an unusual opportunity for men everywhere to get in the welding business right in their own communities, and take over the work these men have left behind. No special training is required, for now with the new DYNAMIC Super-Charged Transformer-Type Welder that works off a 110 volt electric light circuit, men without previous experience, by following the simple, concise home instructions can quickly do finished repair jobs. In this way you may fit yourself to qualify for a big pay job in the defense industry.

WELDS BUMPERS, FENDERS, CYLINDER BLOCKS, BODIES, FRAMES, ETC. Does Farm, Factory and Home Repairs

Many welders make as much as \$15 to \$20 a day. Repair jobs that can be done in less than an hour can make as much as \$5.00. Any number of jobs can be done more efficiently with welding. The DYNAMIC Super-Charged Welder, despite its serviceability, is so easily portable it can be carried around by hand and taken right to the job. This is an added feature whose value you will appreciate once you are in welding.

WORKS ON IRON STEEL, TIN, BRASS, COPPER, AND ALL OTHER METALS

With this Welder you can work on all kinds of metal—nothing will stump you—you can tackle anything and in no time at all you will be able to do finished repair jobs that will do credit to an expert.

DOES METALLIC AND CARBON ARC WELDING

Can be used efficiently on both types of welding. The cost of using the DYNAMIC Super-Charged Welder is amazingly low—costs only a few cents an hour to operate. It is built so strongly that repairs are practically unknown—you'll never have to worry about them. It cools so efficiently that you can use it continuously without ever having to stop in the midst of a job to let it cool down. **COSTS LESS THAN 6¢ A DAY.** You can buy the DYNAMIC Super-Charged Welder on easy payments. Over a year's time, it would cost you less than 6¢ a day. Once you have your DYNAMIC outfit, you are all set in a profitable welding business of your own—you boss it yourself. Send coupon for free particulars today.

for Only \$19.75

EASY PAYMENTS



These pictures show how easy it is to operate the Dynamic Super-Charged Welder.



READ WHAT USERS SAY

Electrician says: "It is the best welding outfit." I wish to tell you that I demonstrated your welding outfit to a great many people, and they all agreed with me that it did the best welding job they ever saw. A. L., Bristol, Conn.

Mechanic Praises Welder

I have received my welder and like it very much. I am a mechanic and electrician by trade, so I can appreciate its usefulness to others. P. C., Perry, N. Y.

Repair Shop Owner Tells About Dynamic

I want to say I operate a repair garage and I am more than satisfied with the welder. It will do more than you say. C. P., Butler, Ohio.

Greatest Portable Outfit

I must say it's the greatest portable outfit any man could wish to own. You may put me on file as a booster. W. J. B., St. John, N. B., Canada.

MAKE BIG PROFITS FOR INTRODUCING: You can make big profits introducing to garages, factories, mechanics, janitors and maintenance men the new DYNAMIC Super-Charged Welder—we'll let you try it for ten days at our risk so you can be convinced of the immense sales possibilities. Get our big profit plan and ten day trial offer. Just send attached coupon for free particulars today!

DYNAMIC WELDER CO.

2226-TN SILVERTON ROAD

CHICAGO, ILL.

Dynamic Welder Co., 2226-TN Silverton Rd., Chicago, Ill.

Gentlemen: I want to go into the welding business. Send me free particulars on how I can learn welding at home and full details on your Dynamic Welder.

AGENTS: Just mark an "X" here and you will receive full particulars of our big profit plan and 10 day trial offer.

Name.....

Address.....

Town..... State.....

JOE DIMAGGIO'S MIGHTY SWING

Now for the first time the amazing stroboscopic camera analyzes the swing that made baseball history



Di Maggio starts that devastating swing...



Squarely...solidly...bat meets ball



With his eyes still focused on the batted ball... Joe follows through in a tremendous release of driving power.

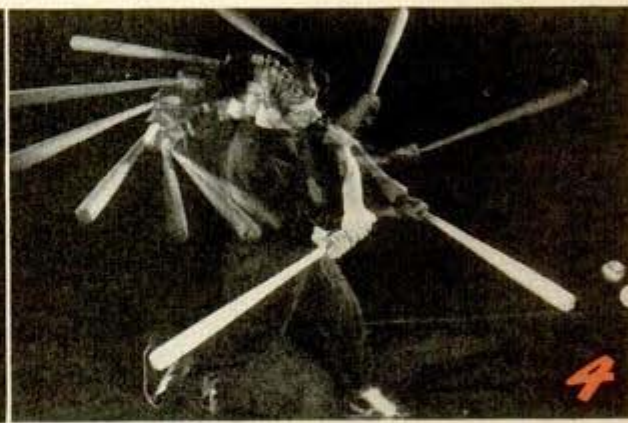

A remarkable series of repetitive flashes taken at 1/30,000 of a second show you the famous Di Maggio swing and follow-through all in this one picture above. Below, at the left, you see Joe enjoying a Camel. Yes, *Camel*—the milder cigarette with less nicotine in the smoke.

I'VE SMOKED
CAMELS
FOR 8 YEARS.
THEY HAVE THE
MILDNESS THAT
COUNTS WITH
ME

Right off the bat, Joe Di Maggio, shown here at home, will tell you: "I find Camels easy on the throat—milder in every way. And they've got the flavor that hits the spot every time."

R. J. Reynolds Tobacco Co.,
Winston-Salem, N. C.



The smoke of slower-burning Camels contains

28% LESS NICOTINE

than the average of the 4 other largest-selling cigarettes tested—less than any of them—according to independent scientific tests of the smoke itself!



CAMEL

THE CIGARETTE OF
COSTLIER TOBACCOS